

# STYLIUS

NLUS 90

A	B	C	D
1	900x820	S21-402	2/2
2	973x79	S21-1590	1/2
3	58x79	S21-1588	1/2
4	58x79	S21-1589	1/2

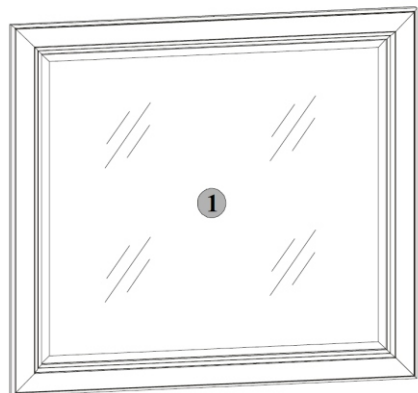
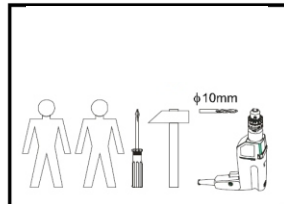

## 2 NLUS 90

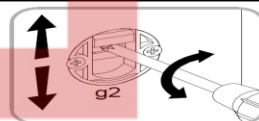
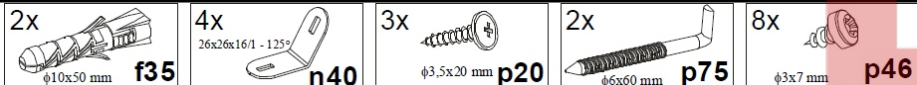
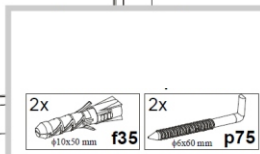
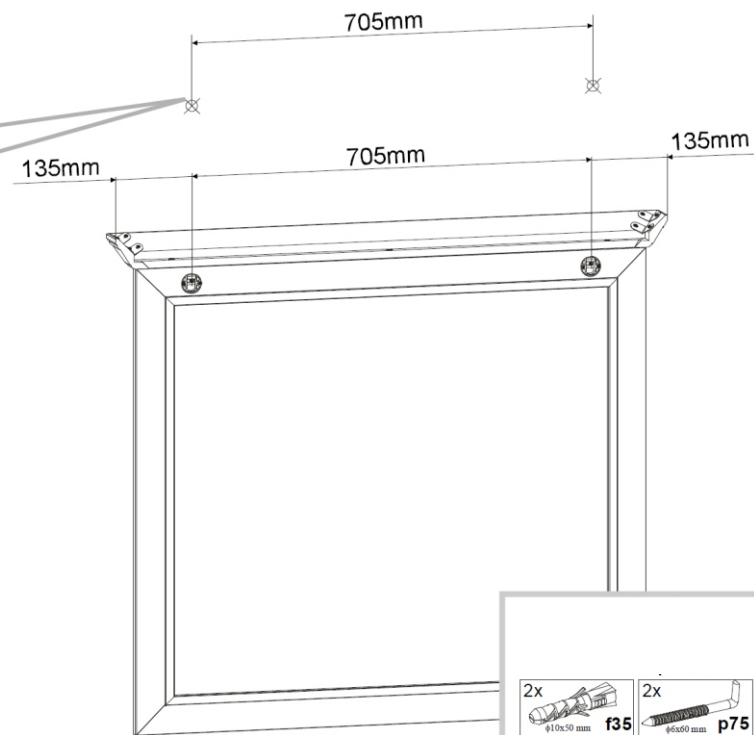
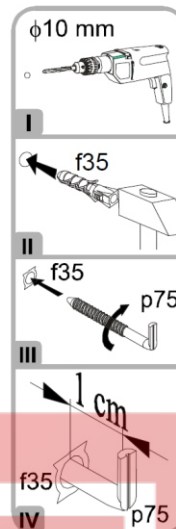

## 1 NLUS 90

