

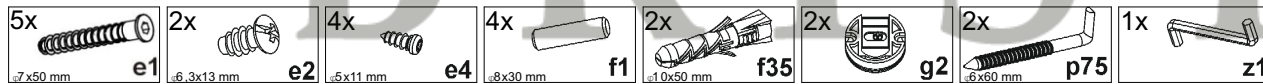

A	B	C (mm)		D
1	S174-312A	1199	230	1/1
2	S174-401A	1200	150	1/1

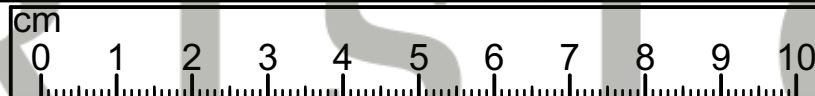
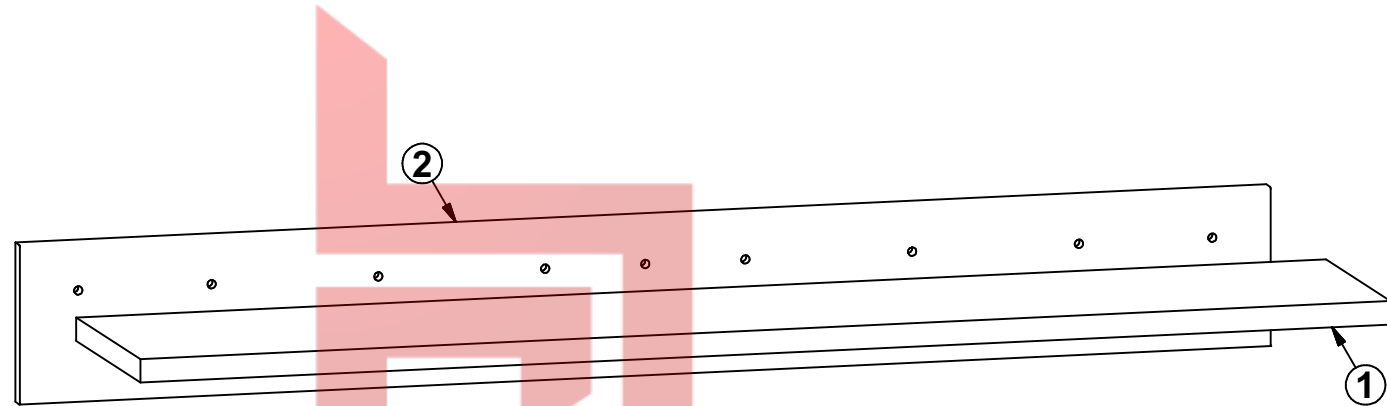
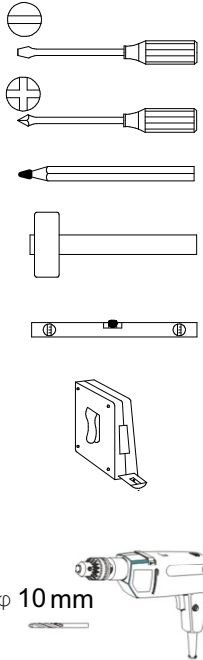
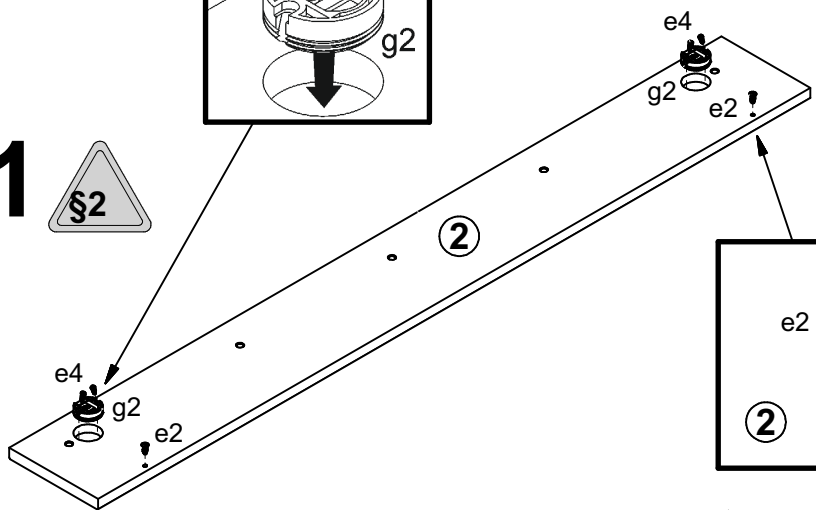
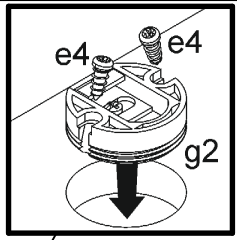

• МАГАЗИН МЕБЛІВ •

1 

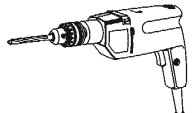
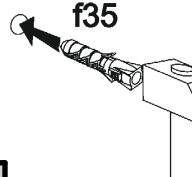
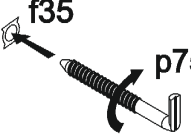
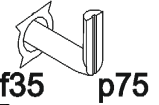

	$\phi 10$ mm 			
---	---	---	---	---

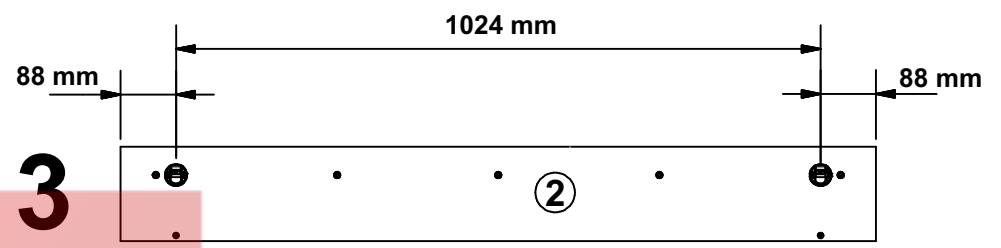

3

2 

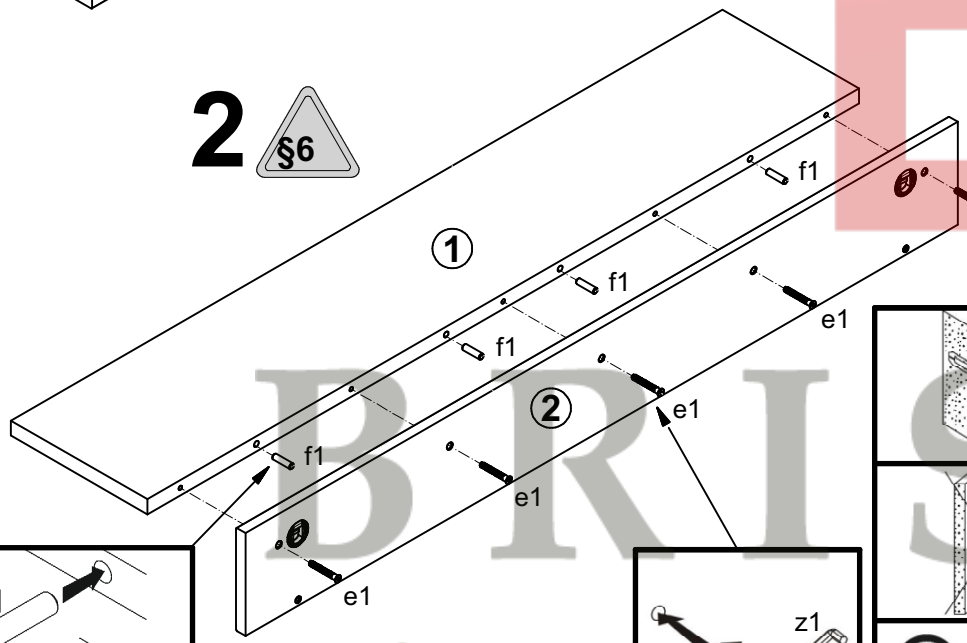

4

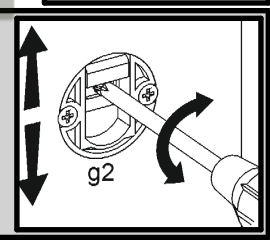
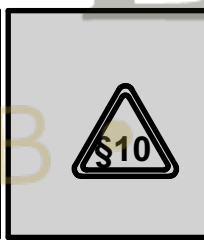
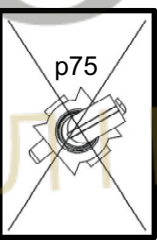
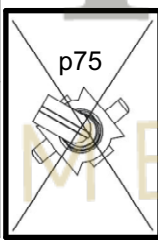
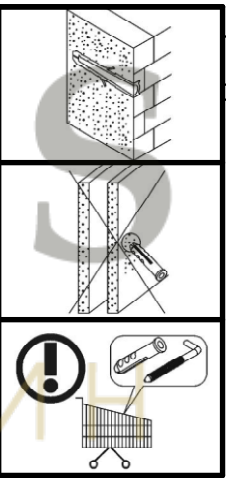
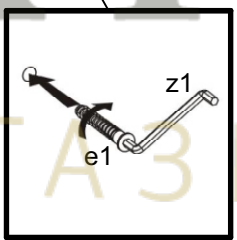
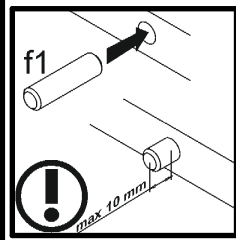
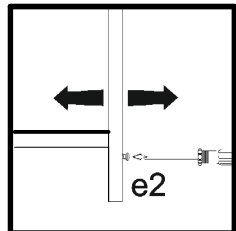
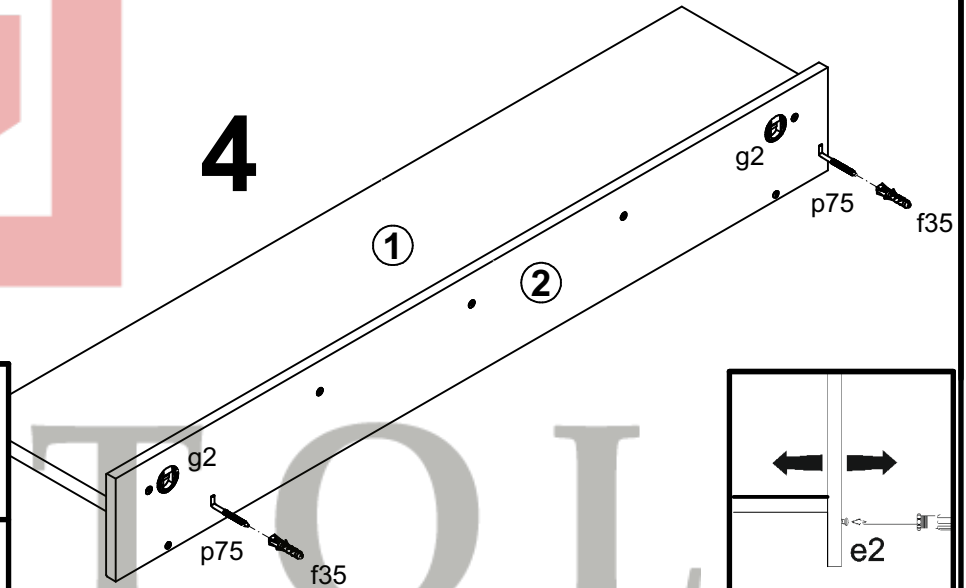

5

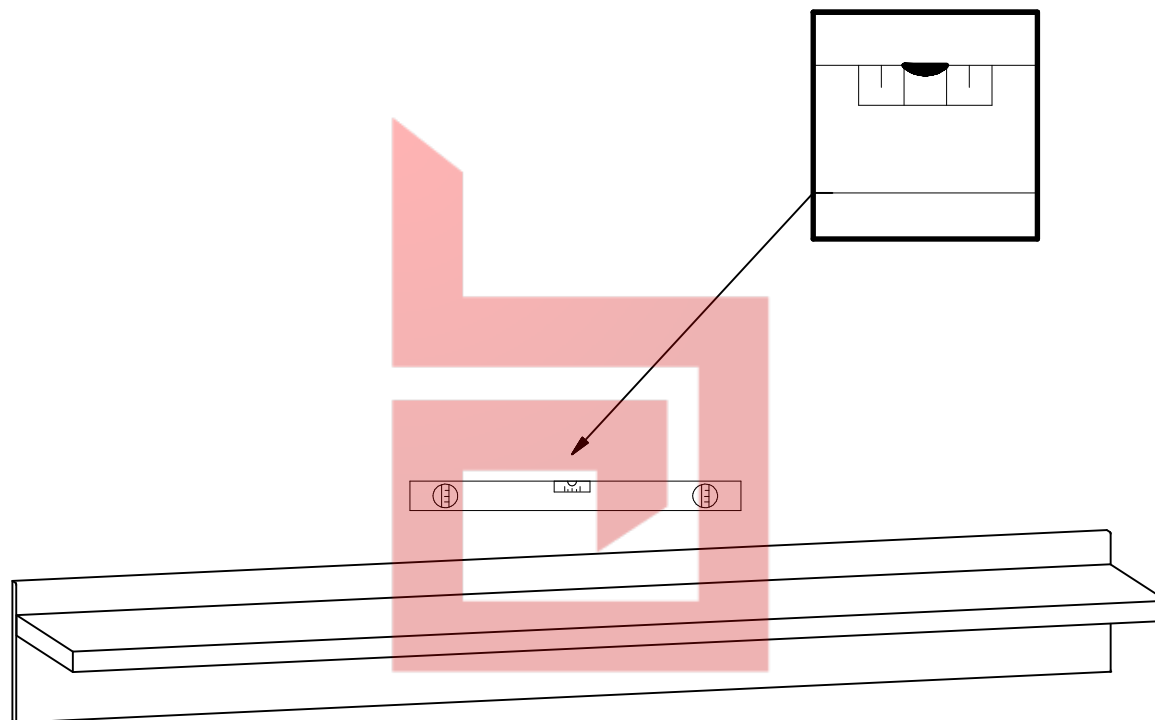

BRISTOL

• МАГАЗИН МЕБЛІВ •