

АРГУС

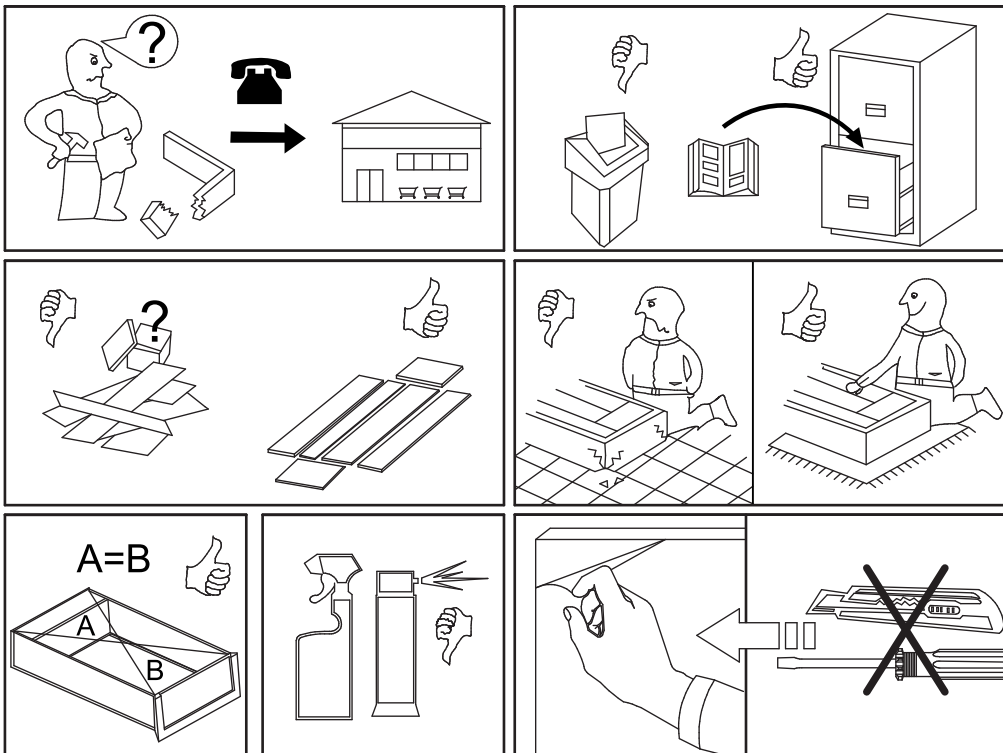

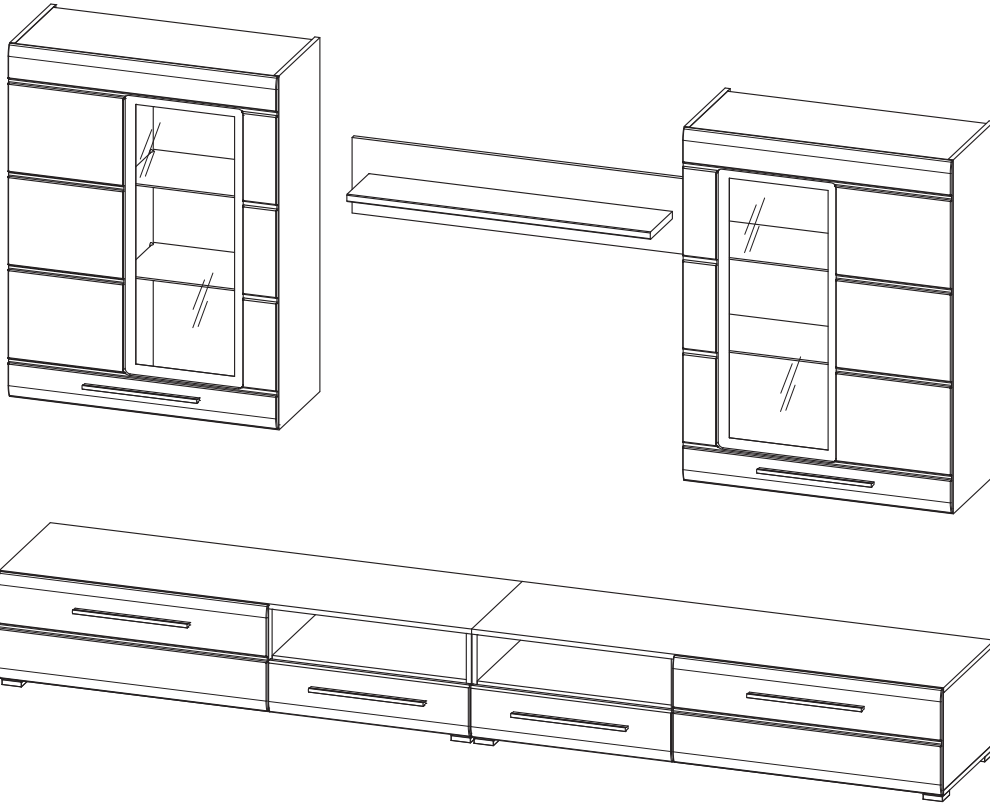

4x K16 a1	6x K0 a2	10x b1	6x L 340 mm c520	16x $\phi 5 \times 17$ mm d3	16x $\phi 7 \times 50$ mm e1
12x $\phi 6 \times 13$ mm e3	4x $\phi 5 \times 11$ mm e4	8x $\phi 5 \times 50$ mm e32	56x $\phi 8 \times 35$ mm f29	2x g2	10x 56x56/20 mm k52
120x i1	16x i2	16x 3 mm i3	2x m48	2x n2	2x 50x12/1,5 mm n3
4x n10	12x 20x13x3,5/1 mm n108	4x n122\1	4x silikon $\phi 8 \times 1,8$ mm o21	4x o43/1	8x $\phi 3,5 \times 13$ mm p1
1x o43/6	4x $\phi 3,5 \times 13$ mm p5	18x $\phi 4 \times 30$ mm p9	28x $\phi 4 \times 30$ mm p21	8x $\phi 3 \times 12$ mm p54	
12x $\phi 2,9 \times 16$ mm p55	16x $\phi 3 \times 16$ mm p52	4x $\phi 3 \times 10$ mm p400	68x $\phi 15 \times 12$ mm #16 r1	68x 30/11 r23	60x $\phi 16$ s2
4x $\phi 5$ s4	2x 350 mm w45^{CL}	2x 350 mm w45^{CR}	2x 350 mm w45^{DL}	2x 350 mm w45^{DR}	1x z1

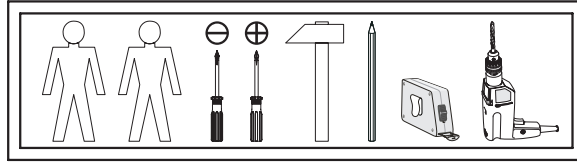
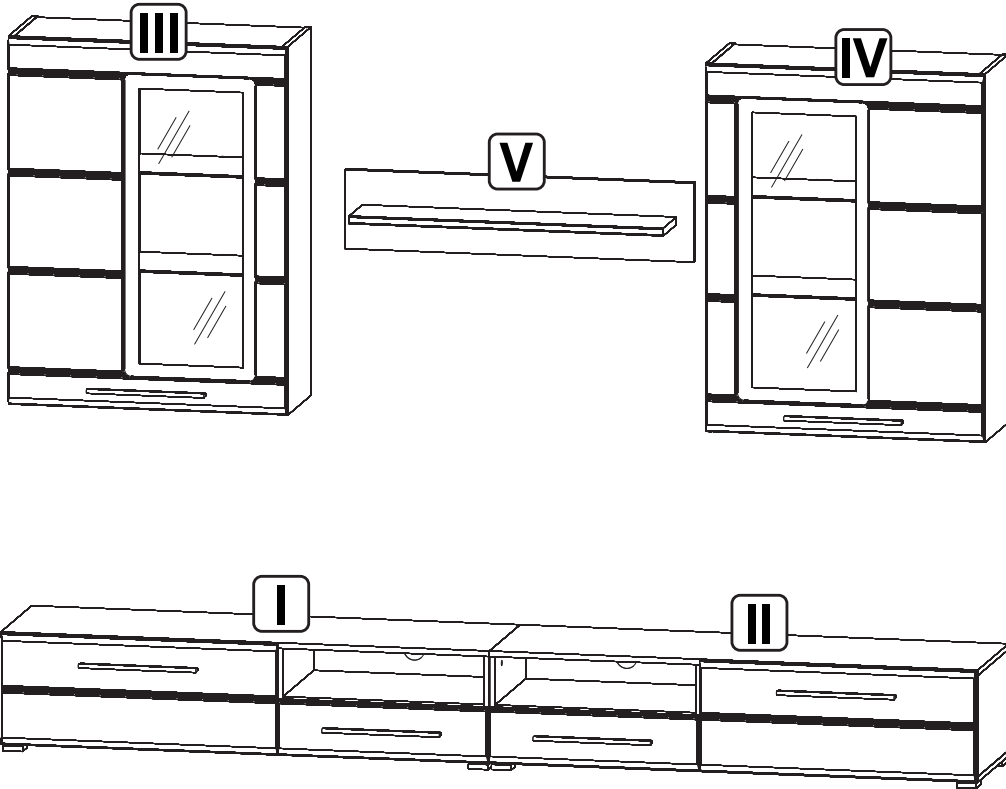
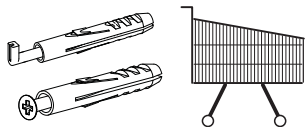

I Тумба РТВ ліва / Тумба РТВ левая

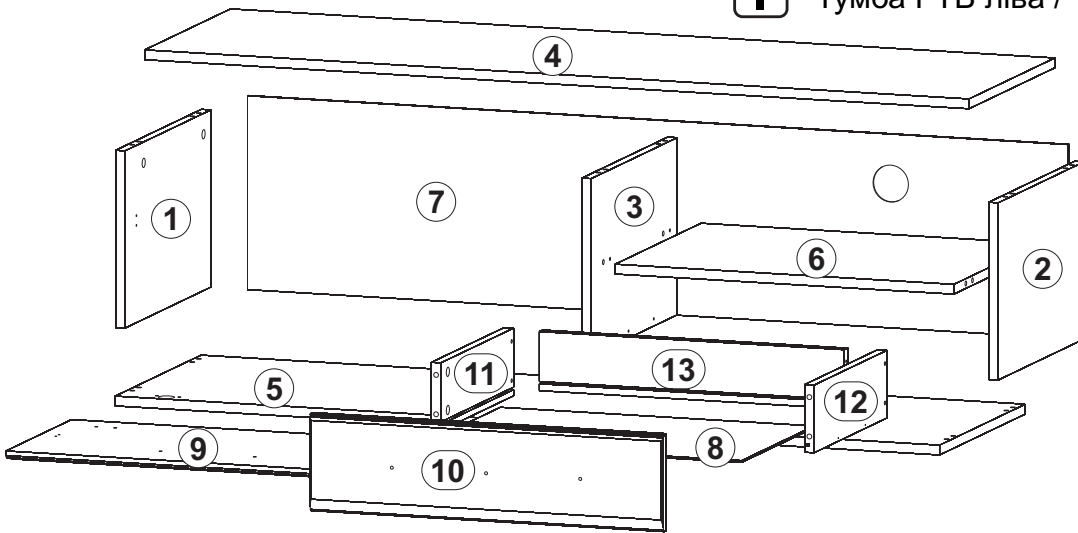

A	B	C	D	
1	PU1-101	288	413	1/5
2	PU1-118	288	413	1/5
3	PU1-117	288	413	1/5
4	PU1-201	1400	413	1/5
5	PU1-220	1400	413	1/5
6	PU1-301	575	413	1/5
7	PU1-901	1394	315	1/5

A	B	C	D	
8	PU1-918	533	349	1/5
9	PU1-017A	792	316	5/5
10	PU1-018A	600	158	5/5
11	PU1-555	350	110	5/5
12	PU1-556	350	110	5/5
13	PU1-557	518	110	3/5



1

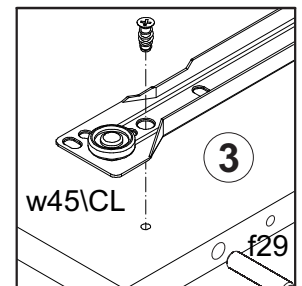
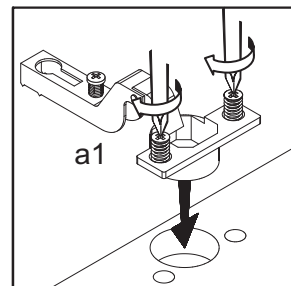
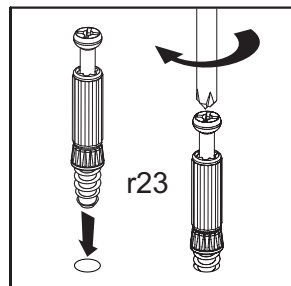
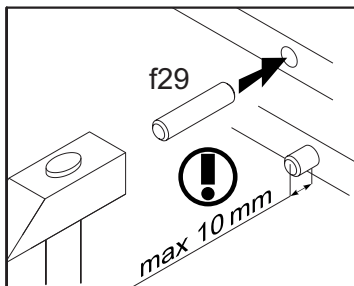
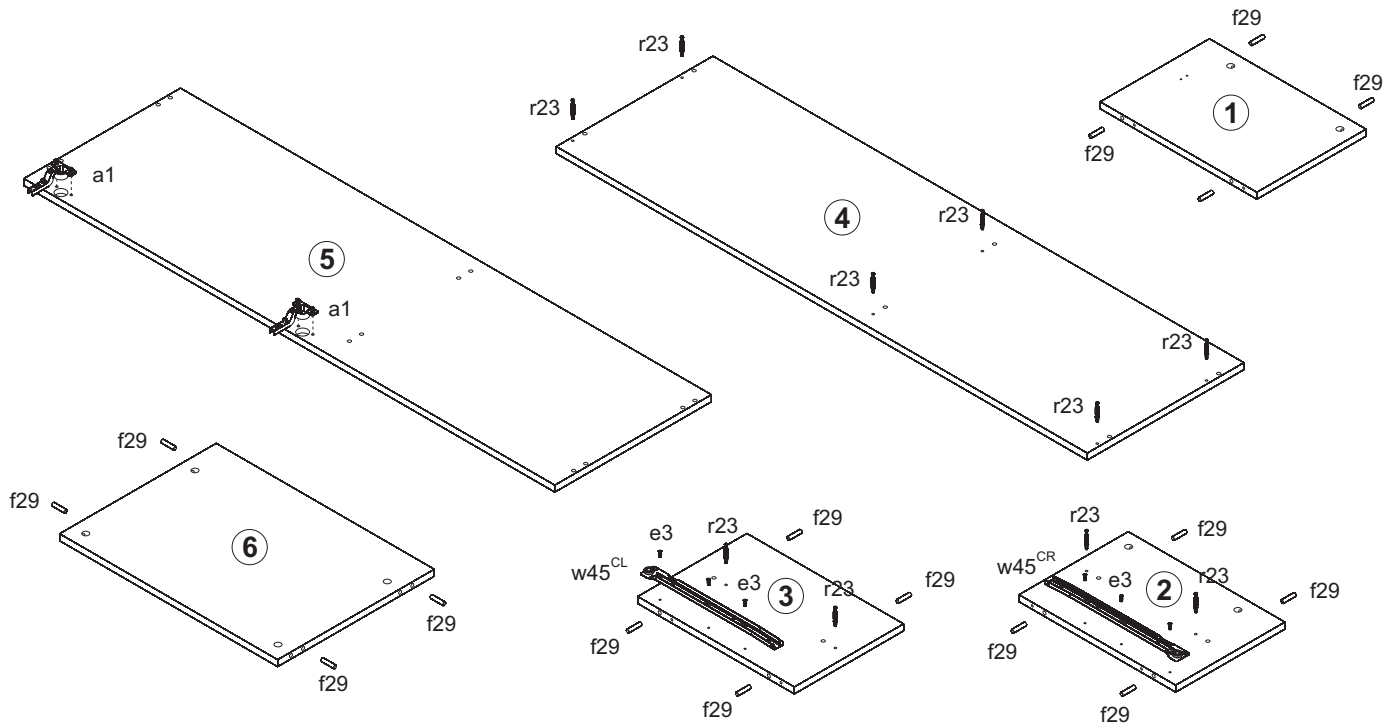
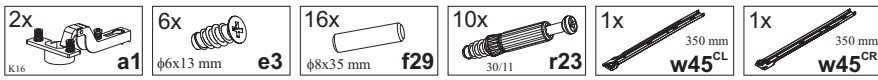

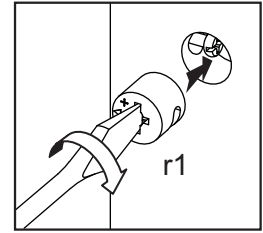
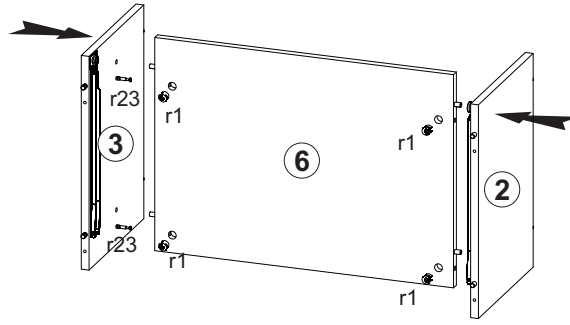
24x $\phi 15 \times 12 \text{ mm}$ #16 r1**3**6x $\phi 7 \times 50 \text{ mm}$ e16x $\phi 15 \times 12 \text{ mm}$ #16 r1

1x z1

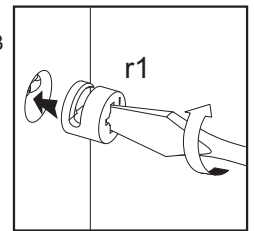
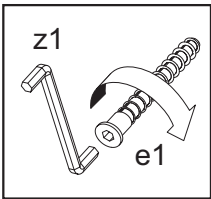
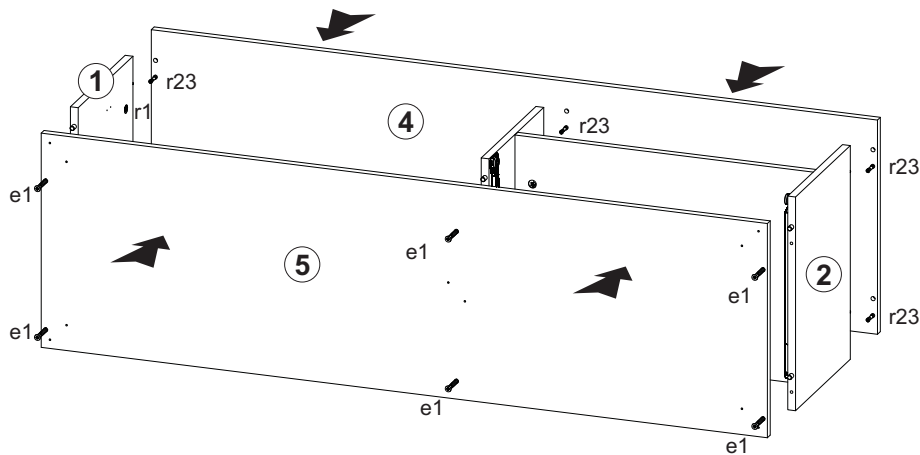
**4**

36x l1

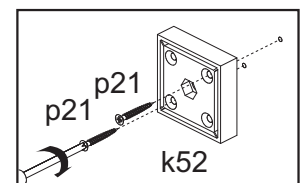
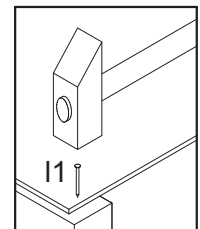
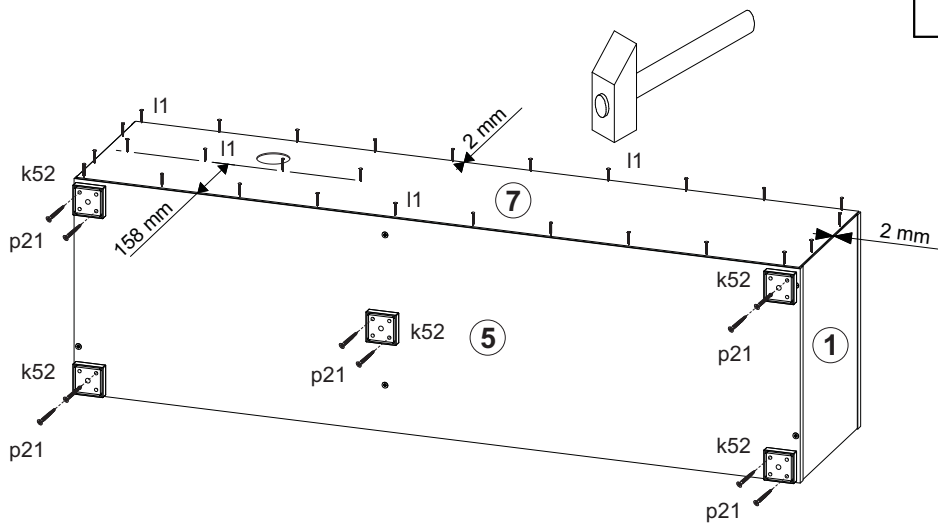
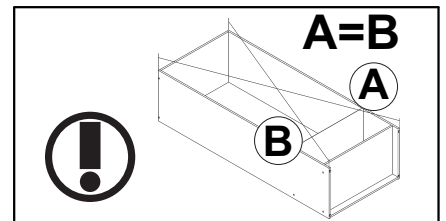
5x $56 \times 56 \times 20 \text{ mm}$ k5210x $\phi 4 \times 30 \text{ mm}$ p21

5

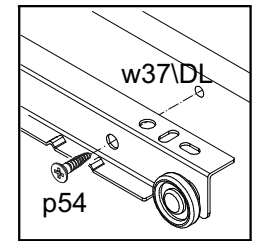
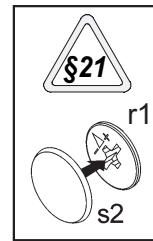
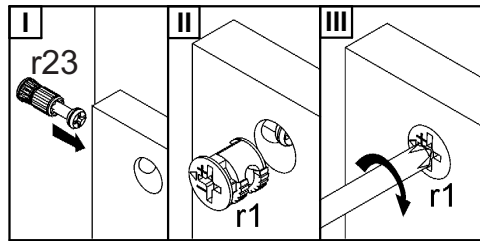
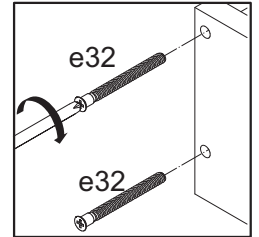
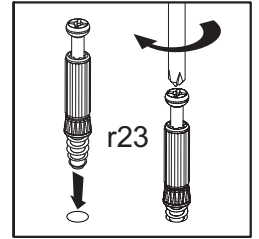
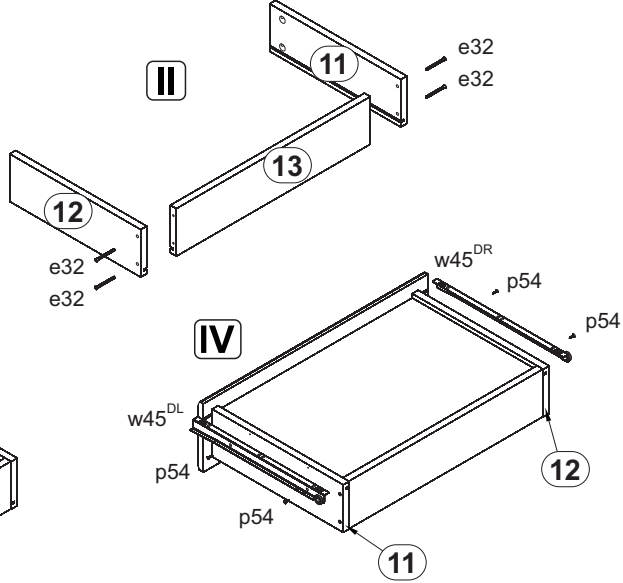
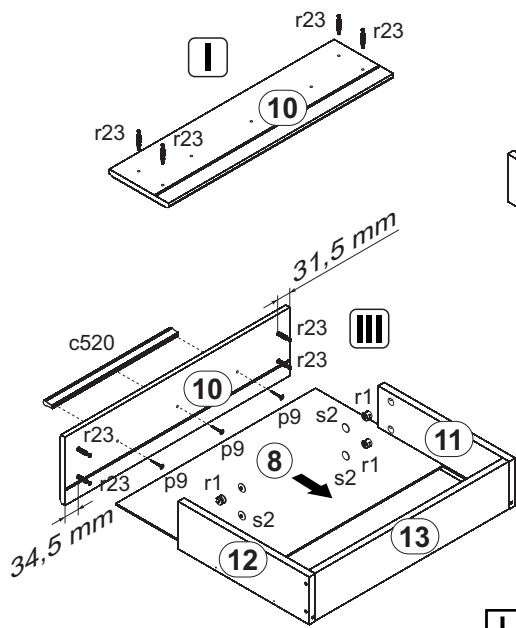
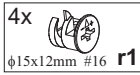
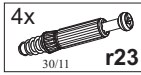
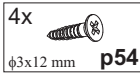
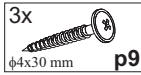
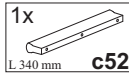

6

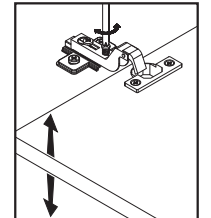
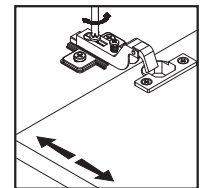
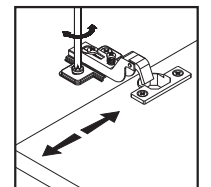
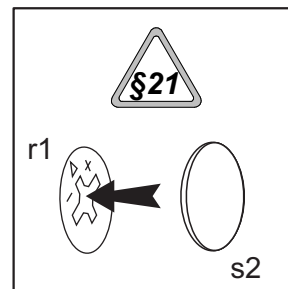
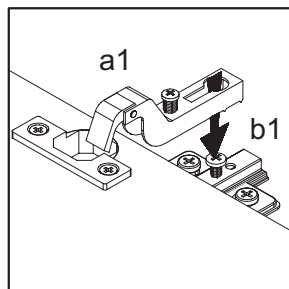
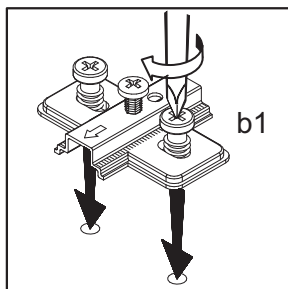
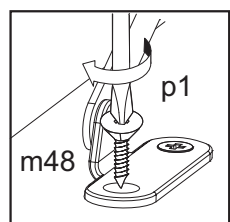
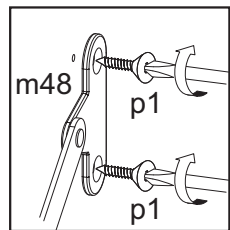
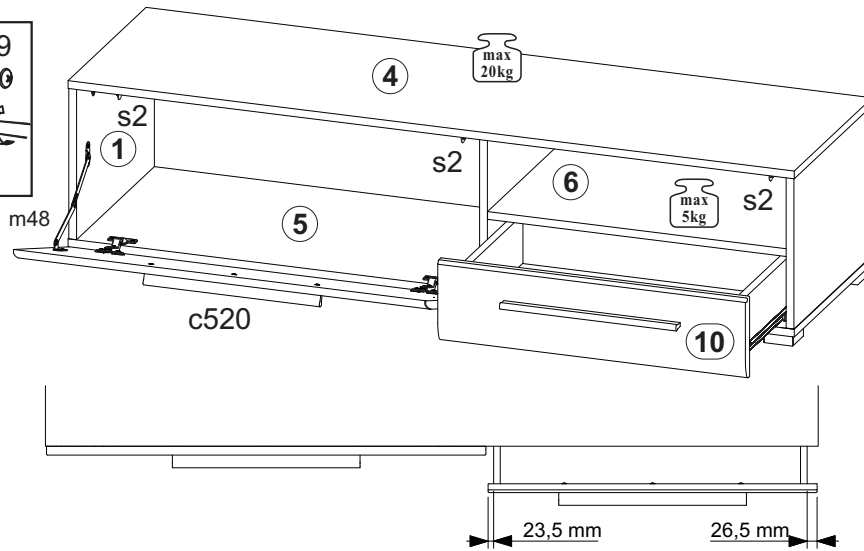
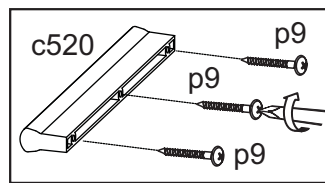
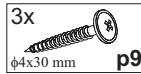
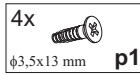
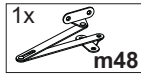
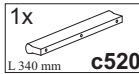
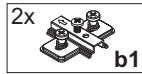



Тумба РТВ права / Тумба РТВ правая

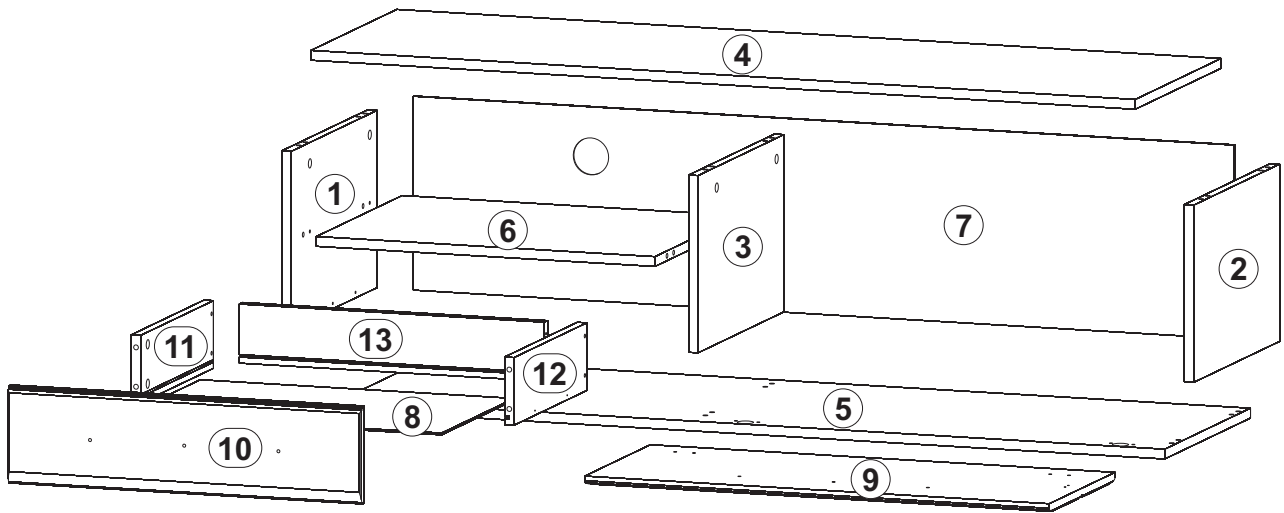

A	B	C	D	
1	PU1-119	288	413	2/5
2	PU1-106	288	413	2/5
3	PU1-120	288	413	2/5
4	PU1-203	1400	413	2/5
5	PU1-221	1400	413	2/5
6	PU1-301	575	413	2/5
7	PU1-907	1394	315	2/5

A	B	C	D	
8	PU1-904	554	378	2/5
9	PU1-020A	792	316	5/5
10	PU1-119A	600	158	5/5
11	PU1-555	350	110	5/5
12	PU1-556	350	110	5/5
13	PU1-518	543	110	3/5



7

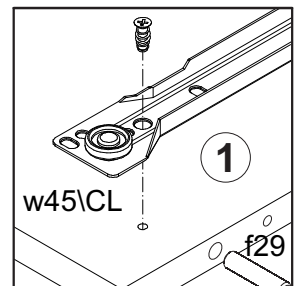
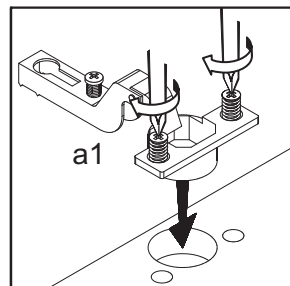
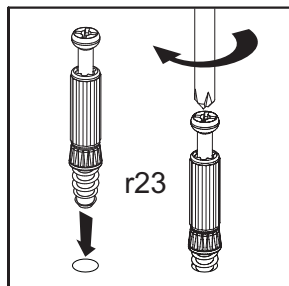
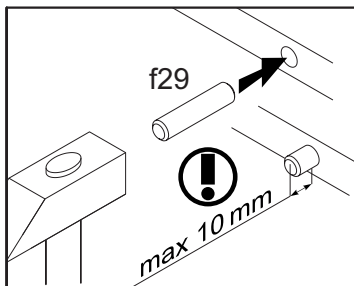
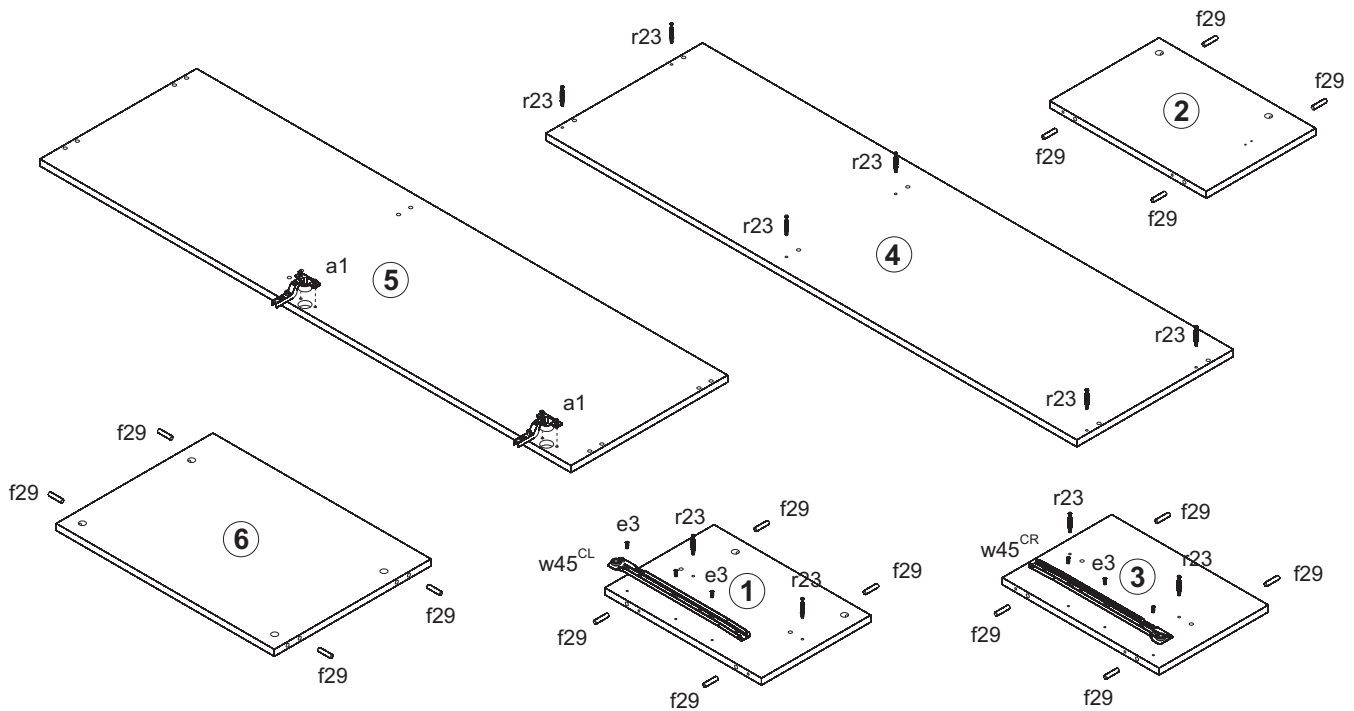
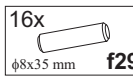
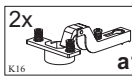

8



4x $\phi 15 \times 12 \text{ mm}$ #16 r1

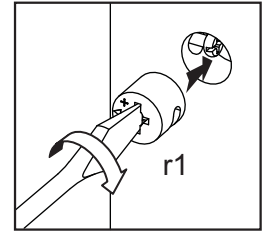
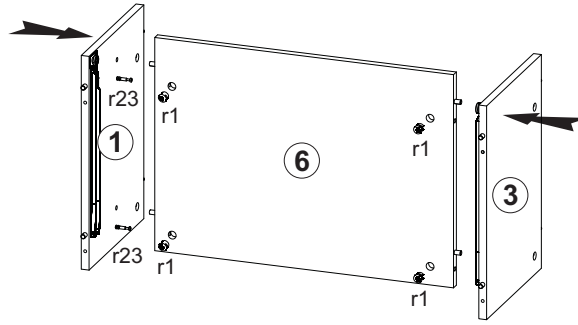

9

6x $\phi 7 \times 50 \text{ mm}$ e1

6x $\phi 15 \times 12 \text{ mm}$ #16 r1

1x z1

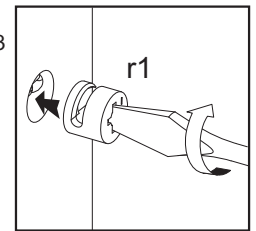
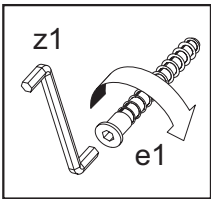
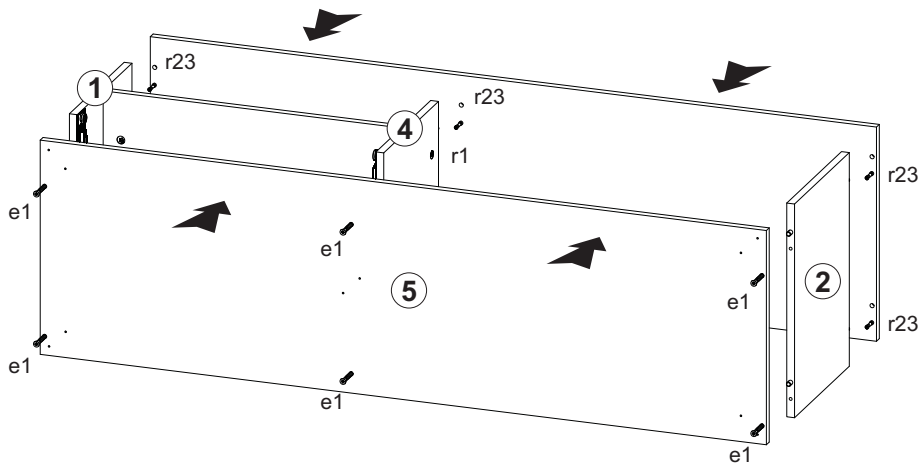

10

36x l1

5x k52 $56 \times 56 \times 20 \text{ mm}$

10x $\phi 4 \times 30 \text{ mm}$ p21

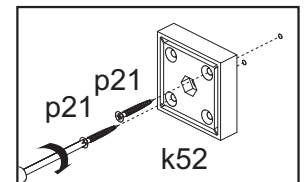
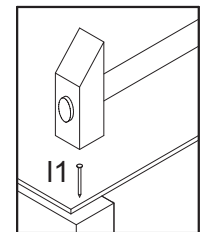
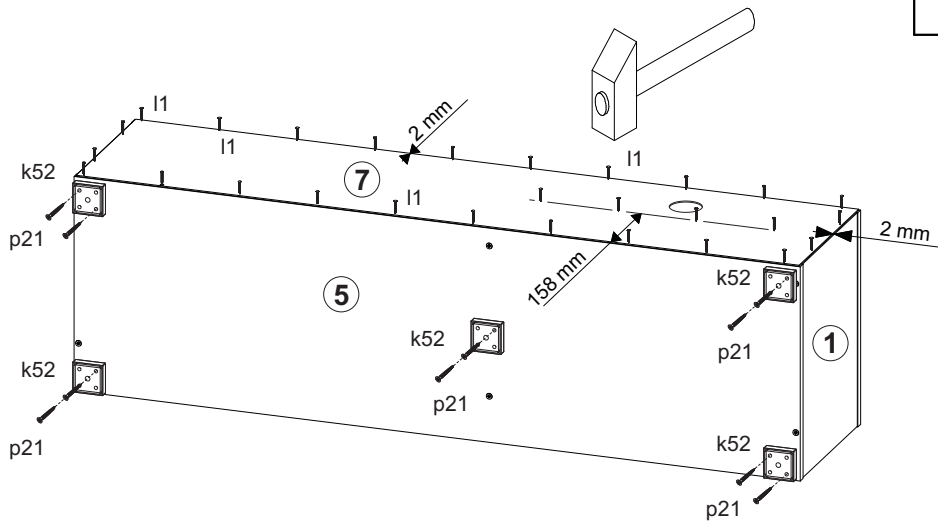
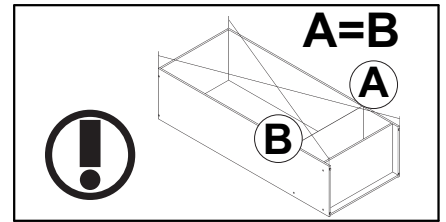

11

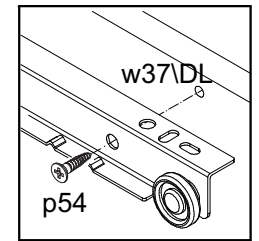
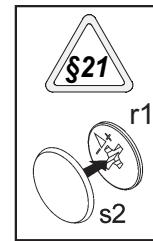
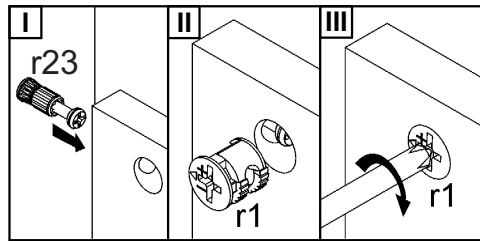
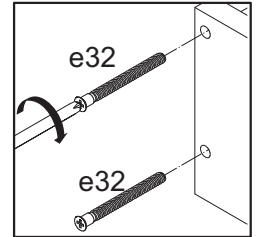
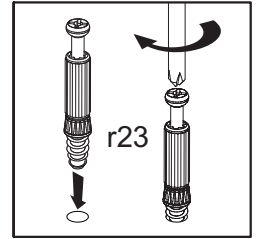
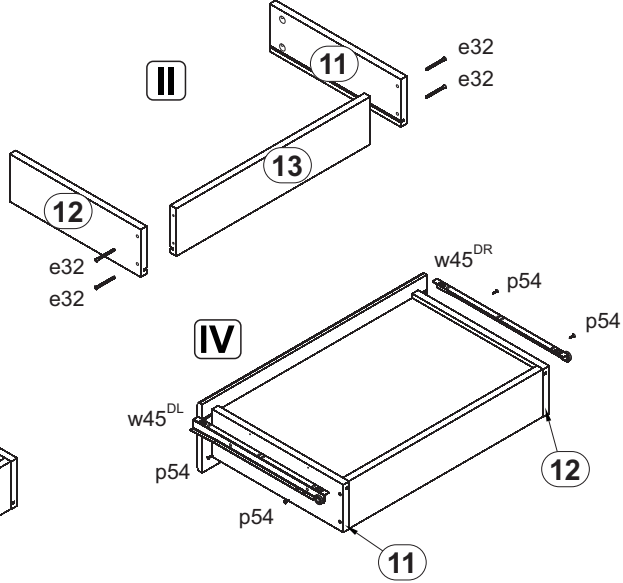
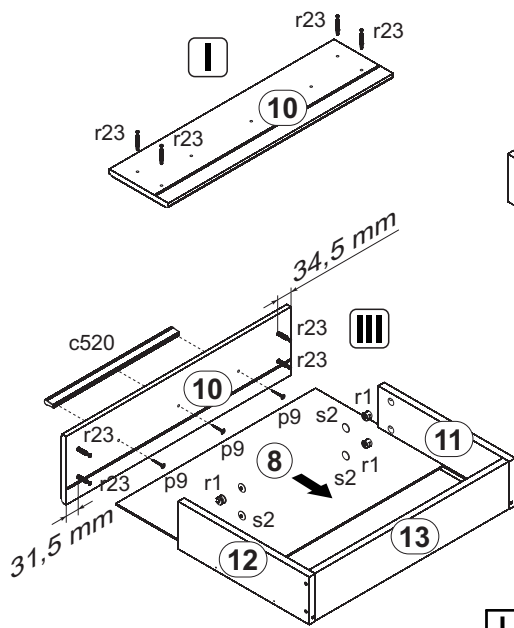
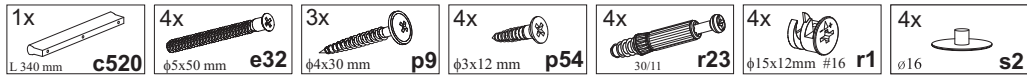

12

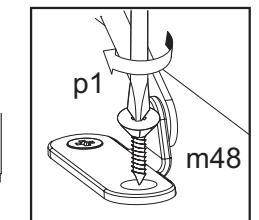
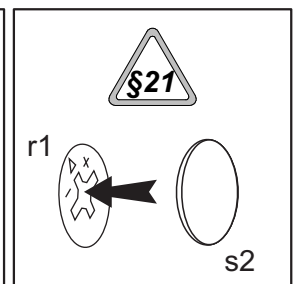
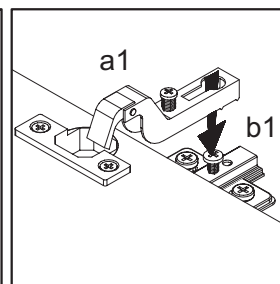
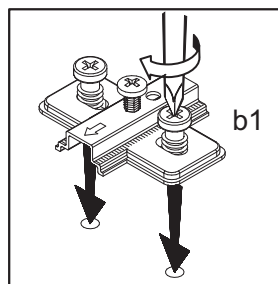
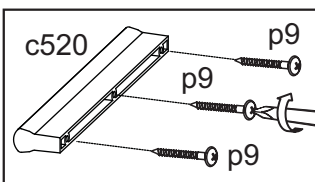
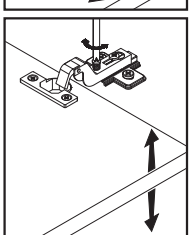
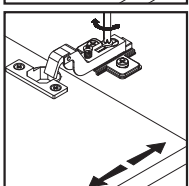
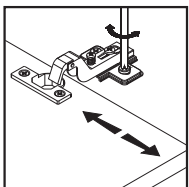
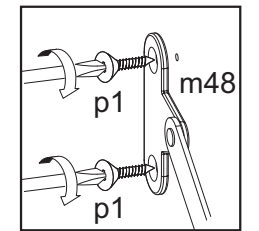
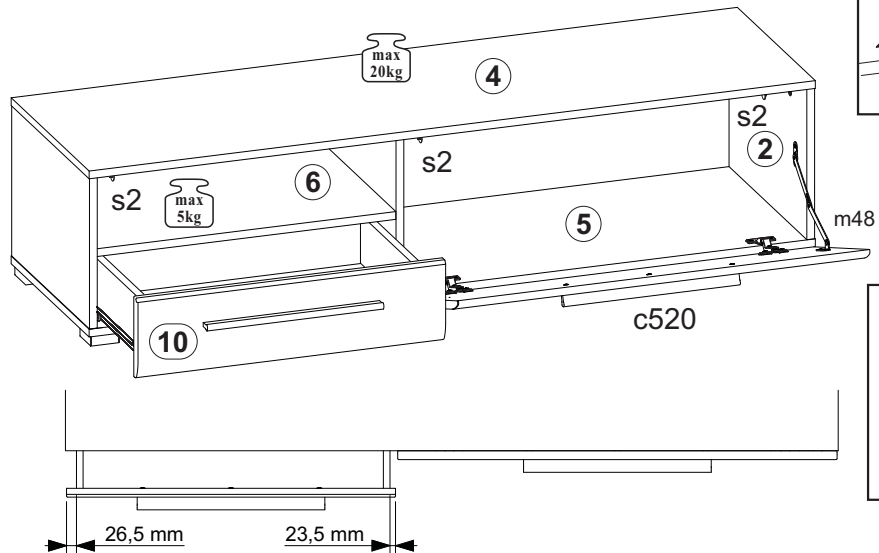
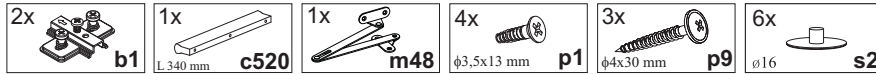



Вітрина навісна ліва / Витрина навесная левая

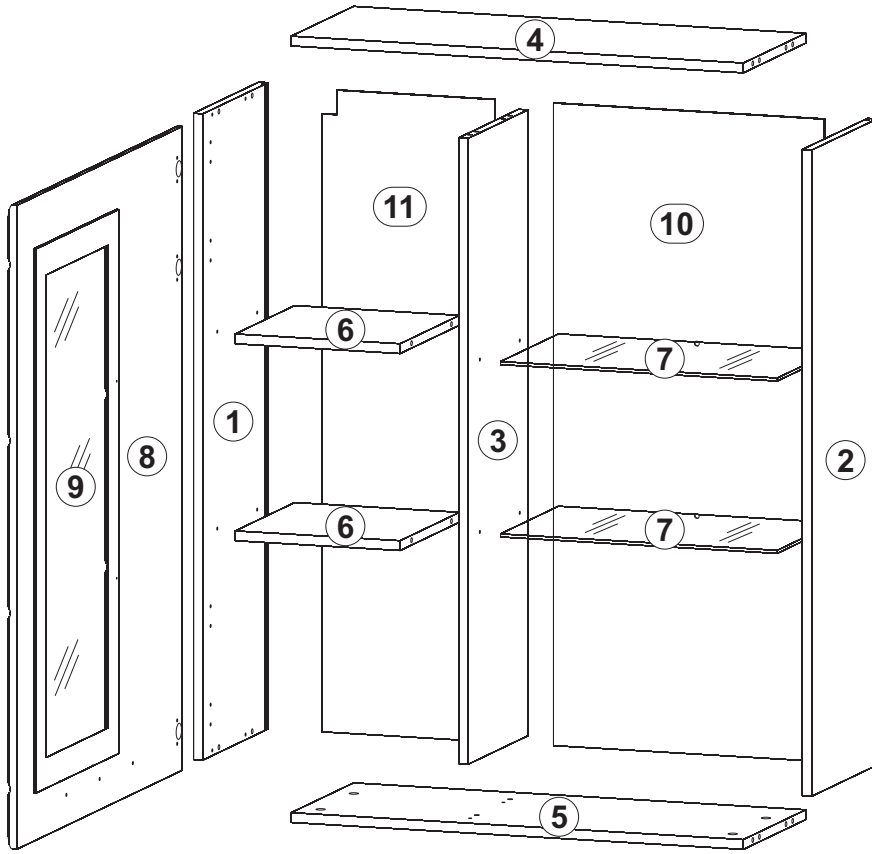



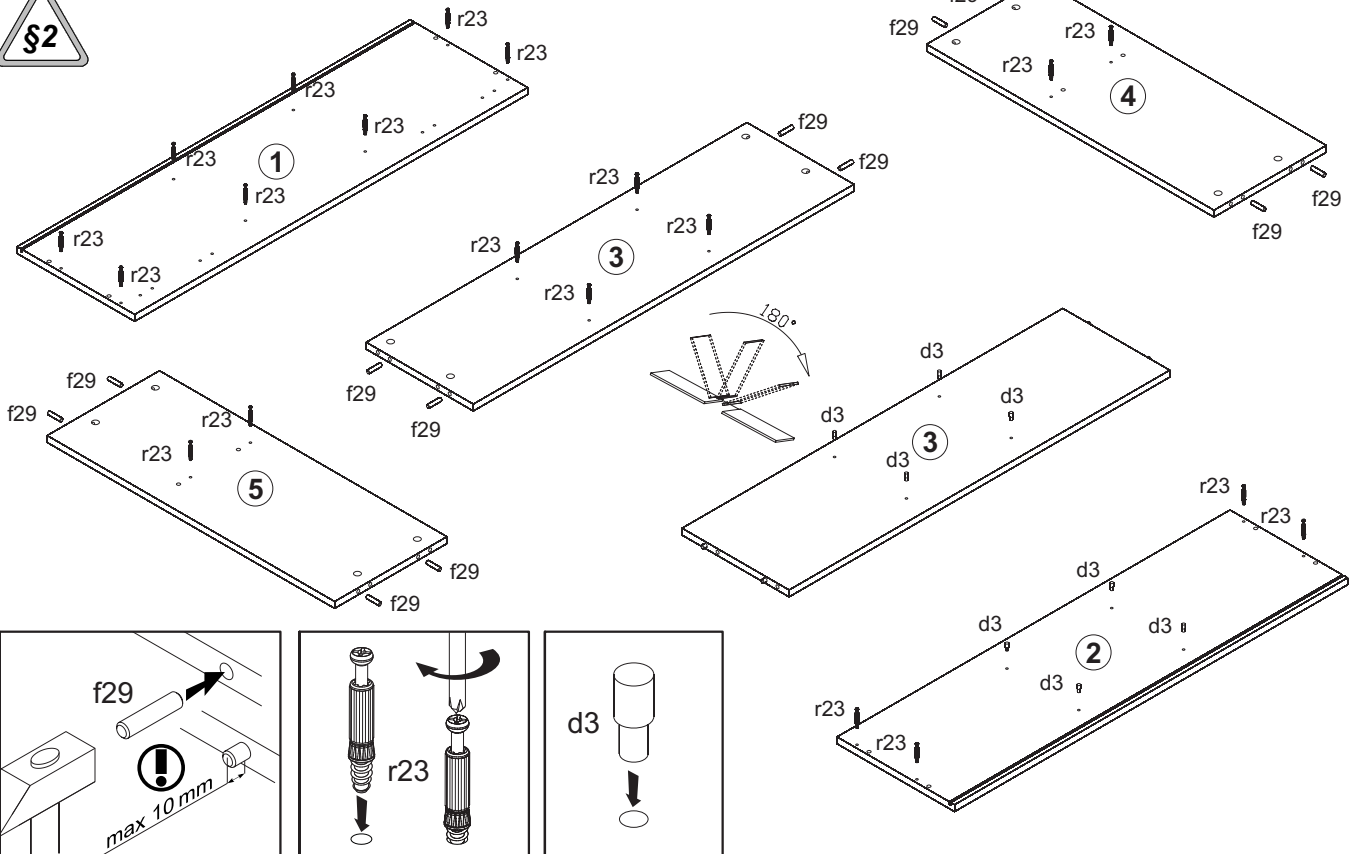
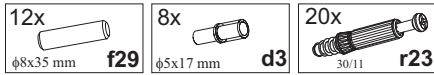

A	B	C	D	
1	PU1-107-01	1050	314	3/5
2	PU1-108-01	1050	314	3/5
3	PU1-109	1017	286	3/5
4	PU1-303	768	300	3/5
5	PU1-302	768	300	3/5
6	PU1-304	280	286	3/5
7	PU1-305	470	279	3/5
8	PU1-002A	1046	796	5/5
9	PU1-501	884	398	5/5
10	PU1-902	1044	485	5/5
11	PU1-903	1044	293	5/5

13

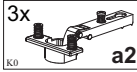
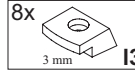

14

- 3x  a2
- 8x  l3 3 mm
- 1x  n3 50x12x1,5 mm
- 8x  p52 $\phi 3 \times 16$ mm
- 2x  p400 $\phi 3 \times 10$ mm

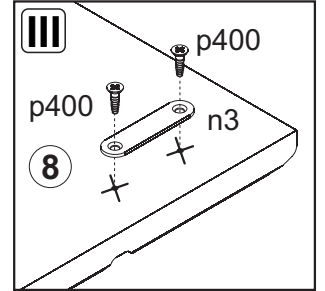
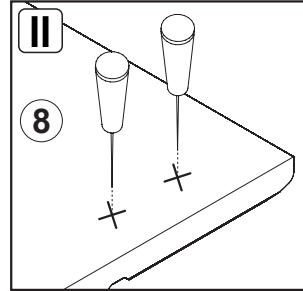
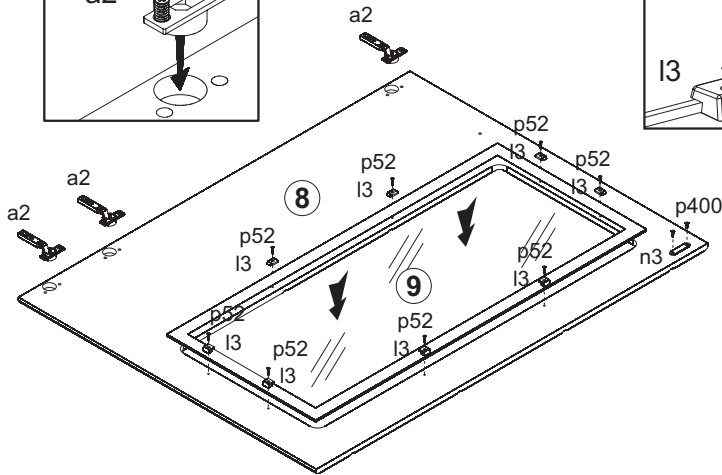
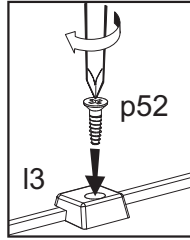
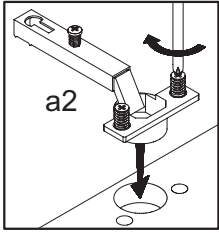
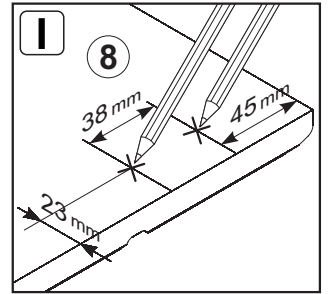
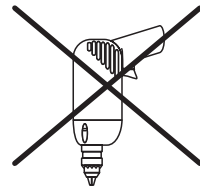

15

- 8x  r1 $\phi 15 \times 12$ mm #16

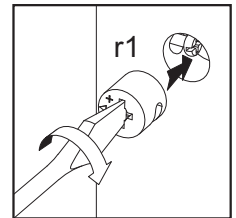
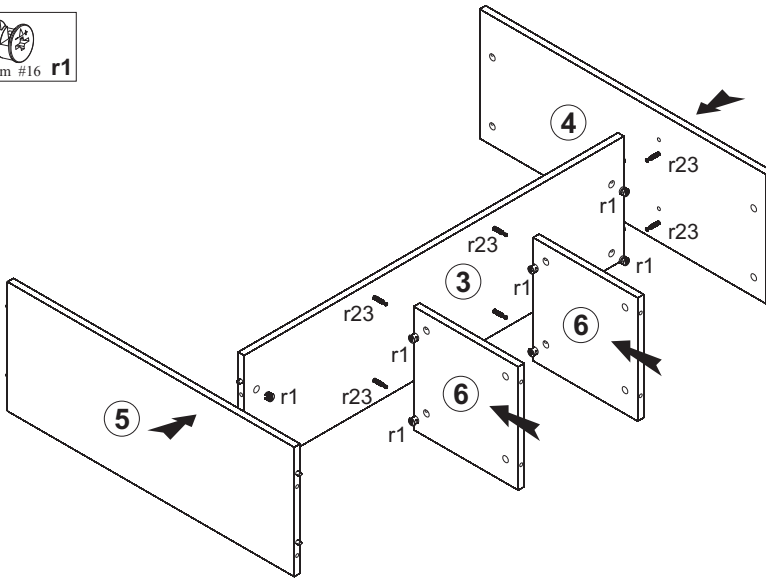

16

- 12x  r1 $\phi 15 \times 12$ mm #16

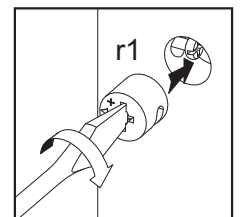
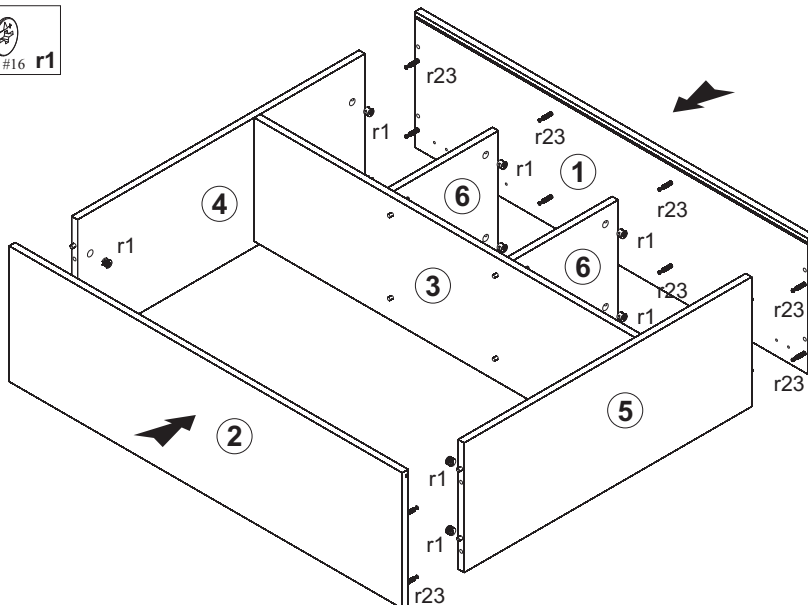

17

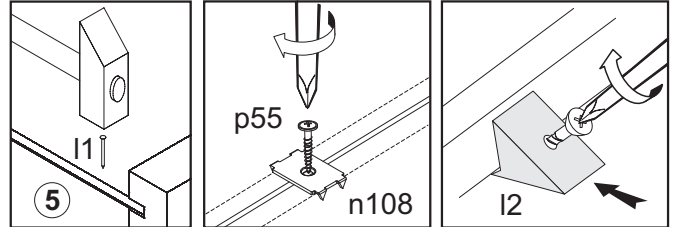
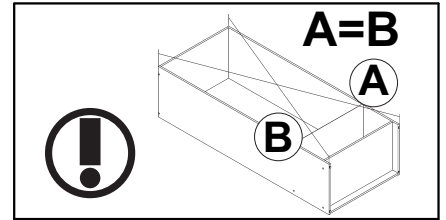
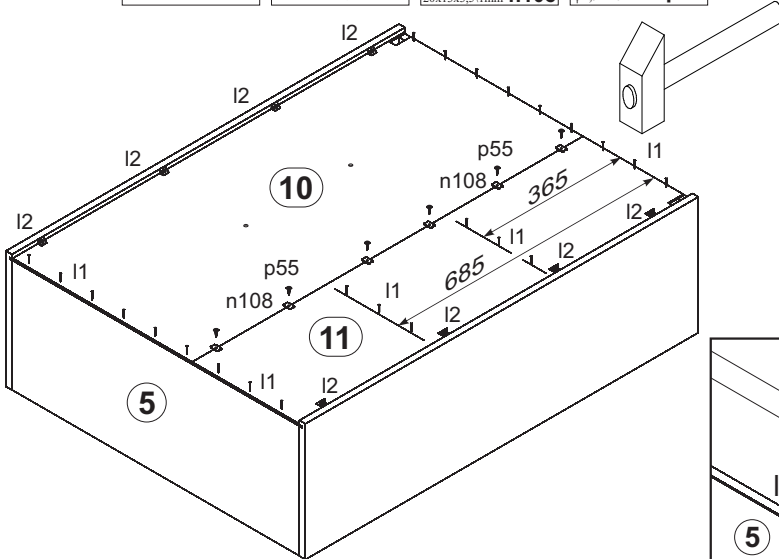
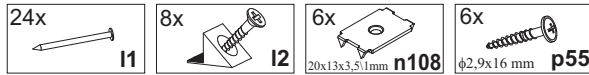

18

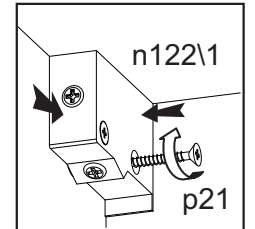
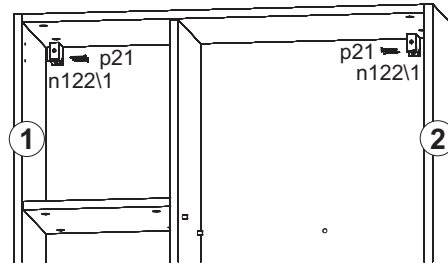
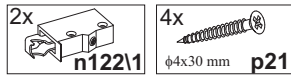

19

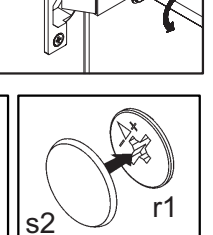
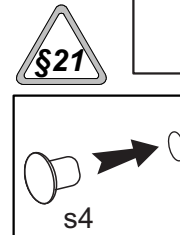
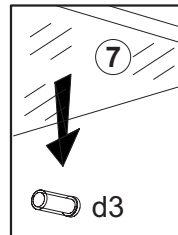
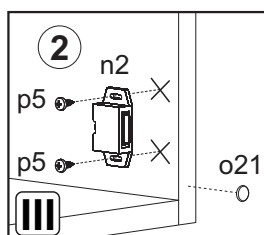
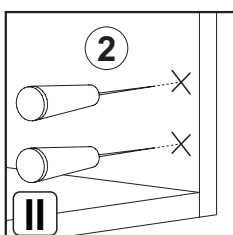
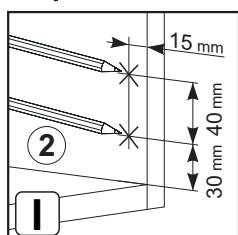
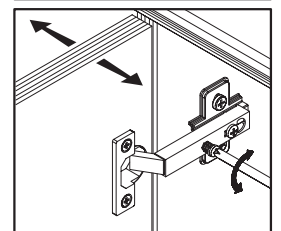
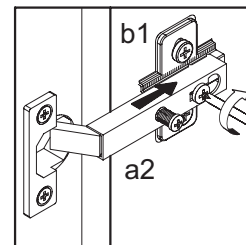
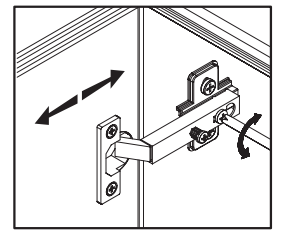
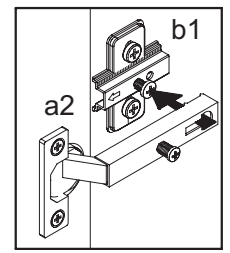
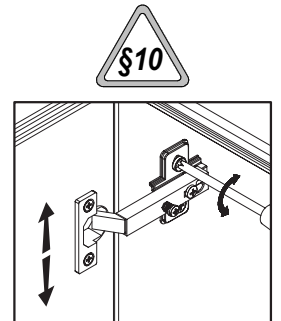
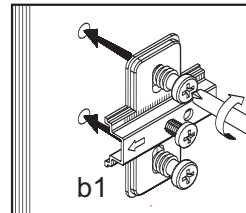
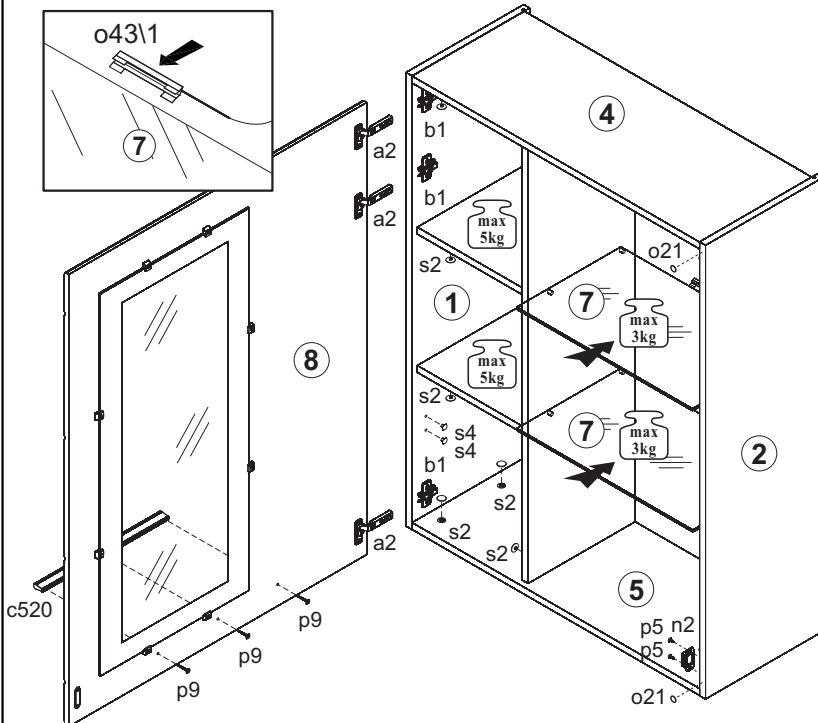

IV

Вітрина навесна права / Витрина навесная правая

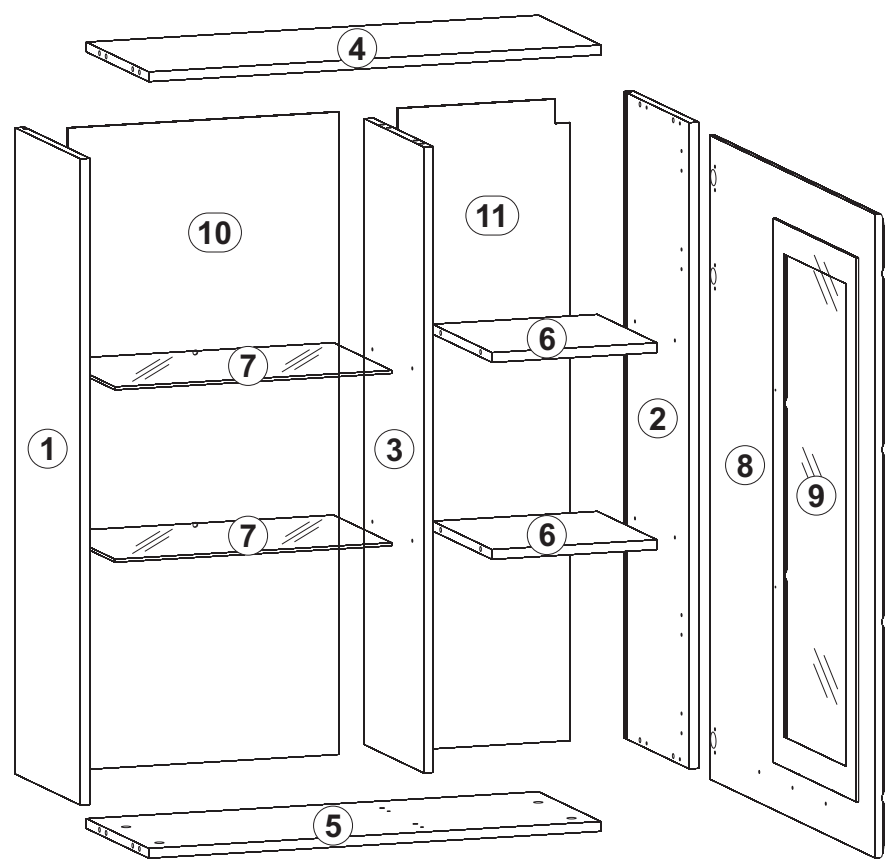

A	B	C	D	
1	PU1-108-01	1050	314	4/5
2	PU1-107-01	1050	314	4/5
3	PU1-109	1017	286	4/5
4	PU1-302	768	300	4/5
5	PU1-303	768	300	4/5
6	PU1-304	280	286	4/5
7	PU1-305	470	279	4/5
8	PU1-007A	1046	796	5/5
9	PU1-501	884	398	5/5
10	PU1-905	1044	485	5/5
11	PU1-906	1044	293	5/5

20

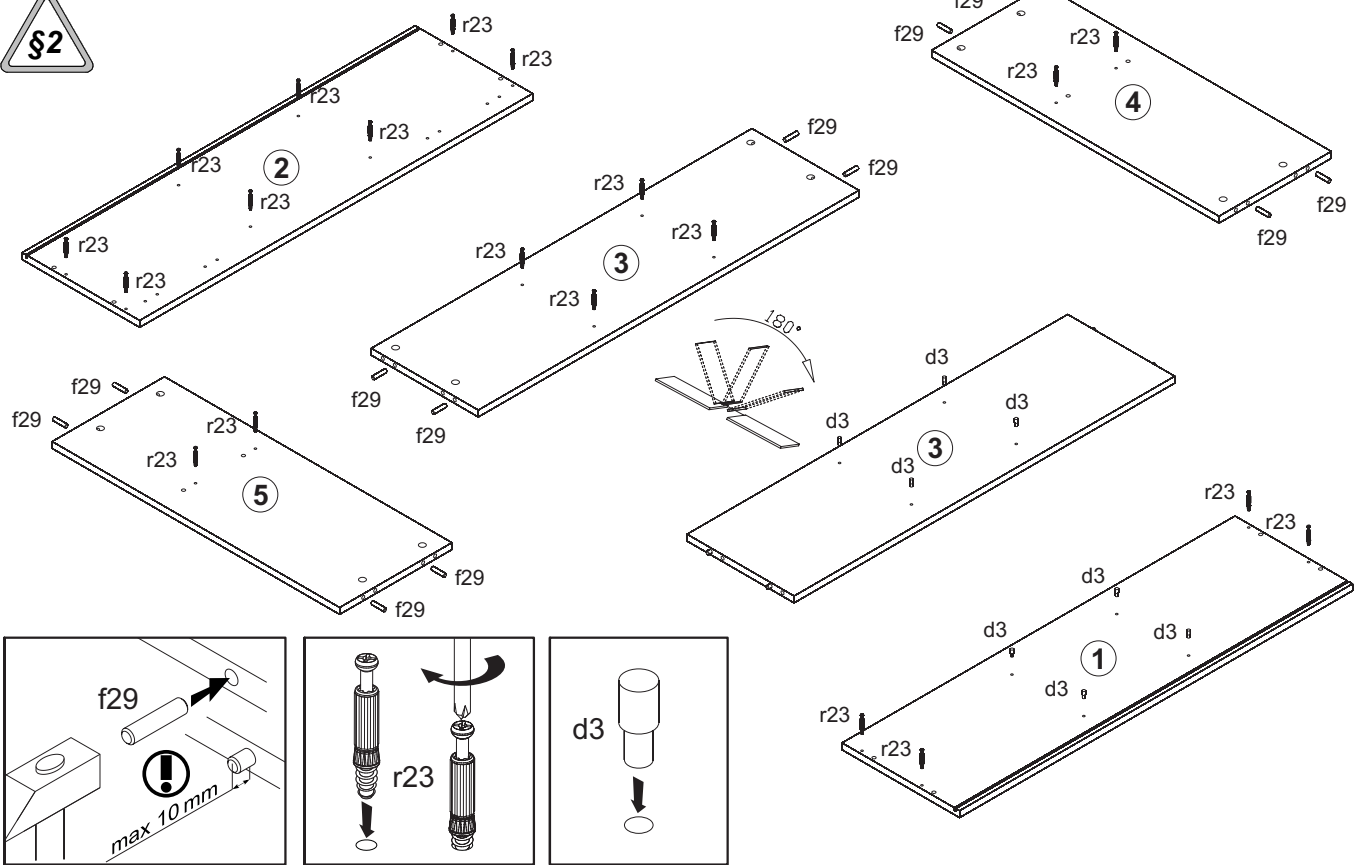
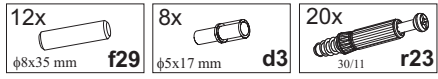

21

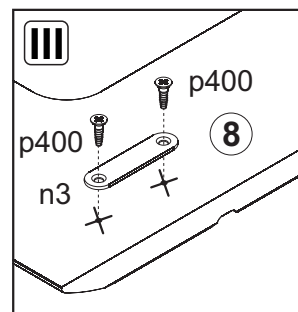
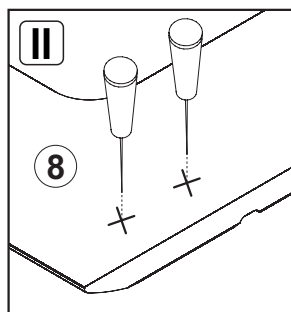
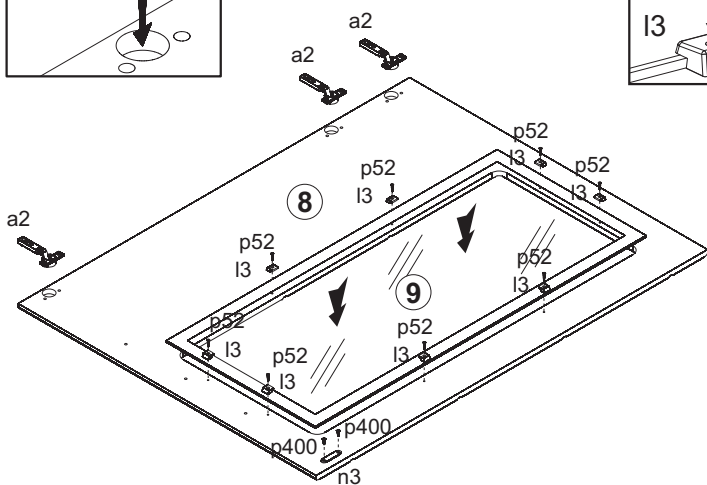
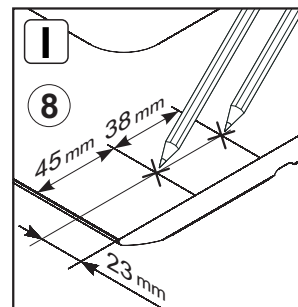
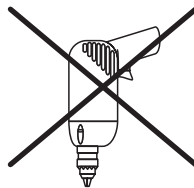
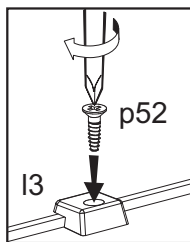
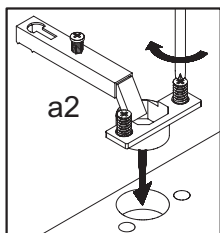
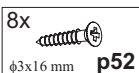
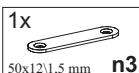
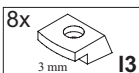
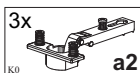

22

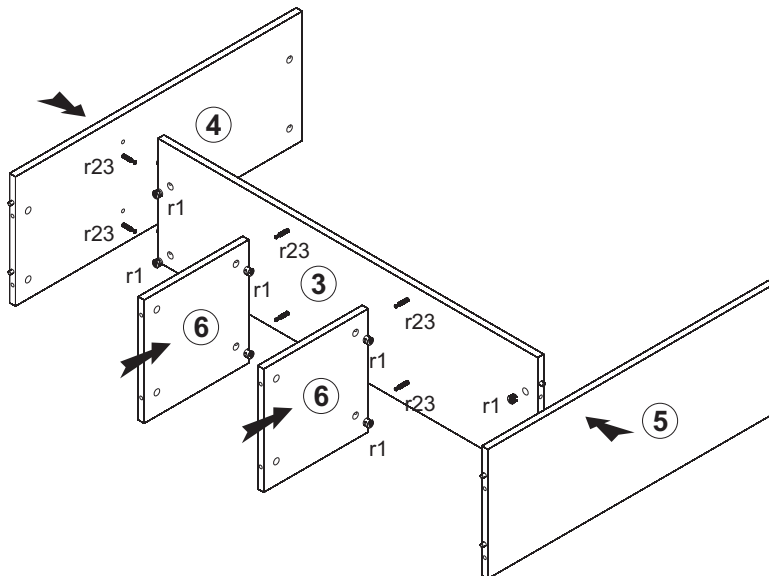
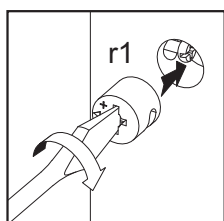

23

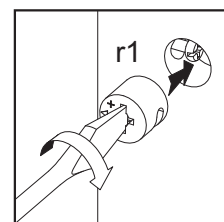
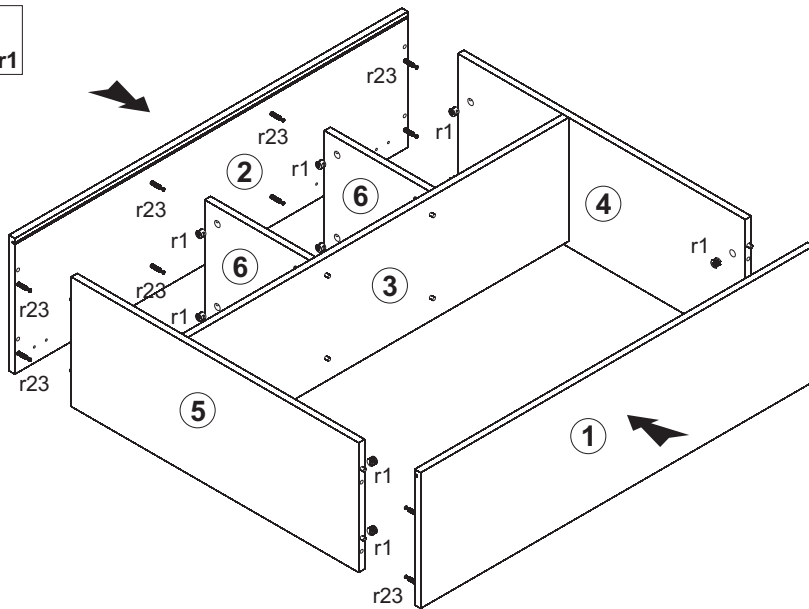

24

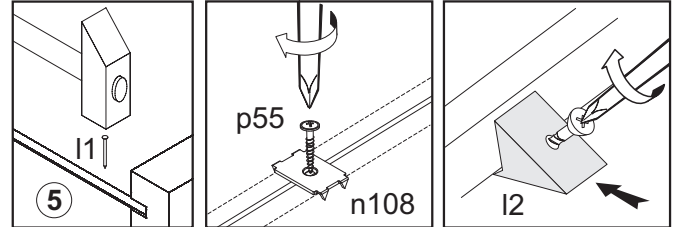
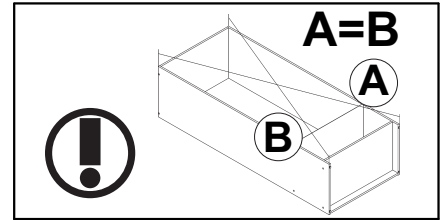
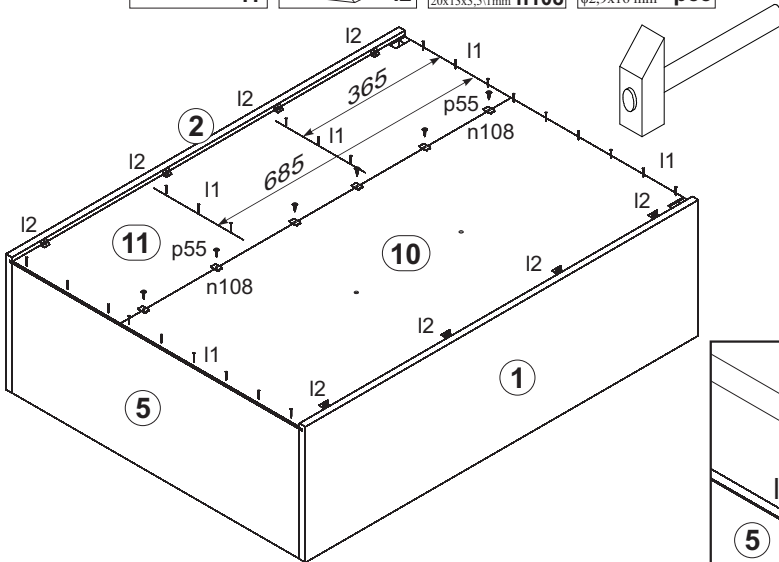
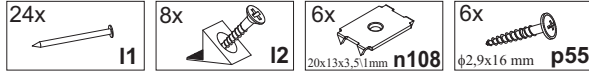

25

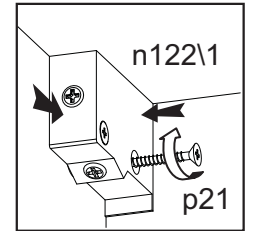
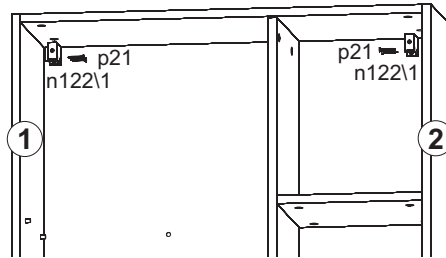
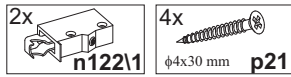

26

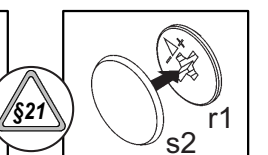
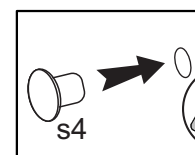
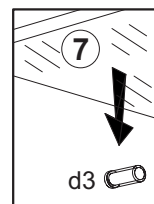
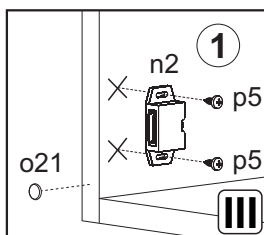
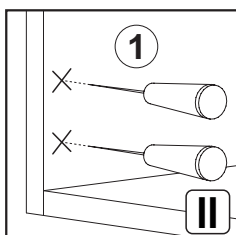
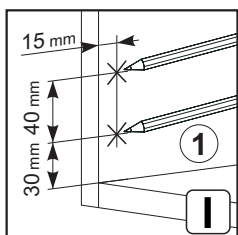
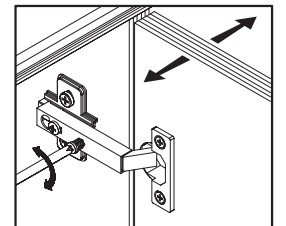
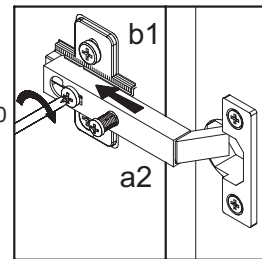
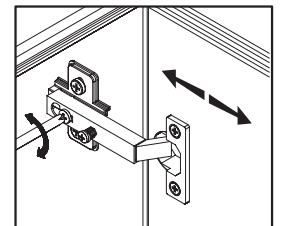
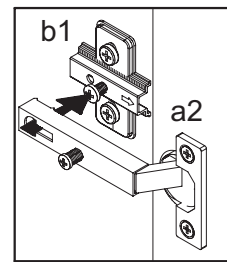
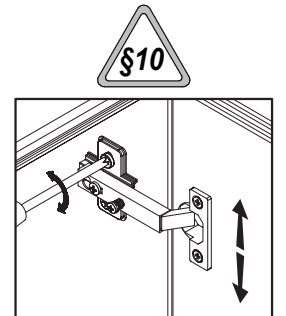
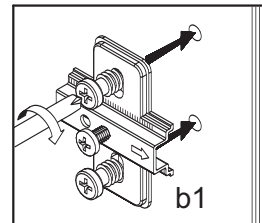
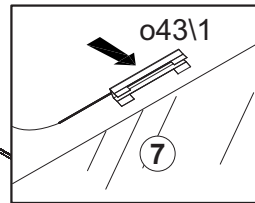
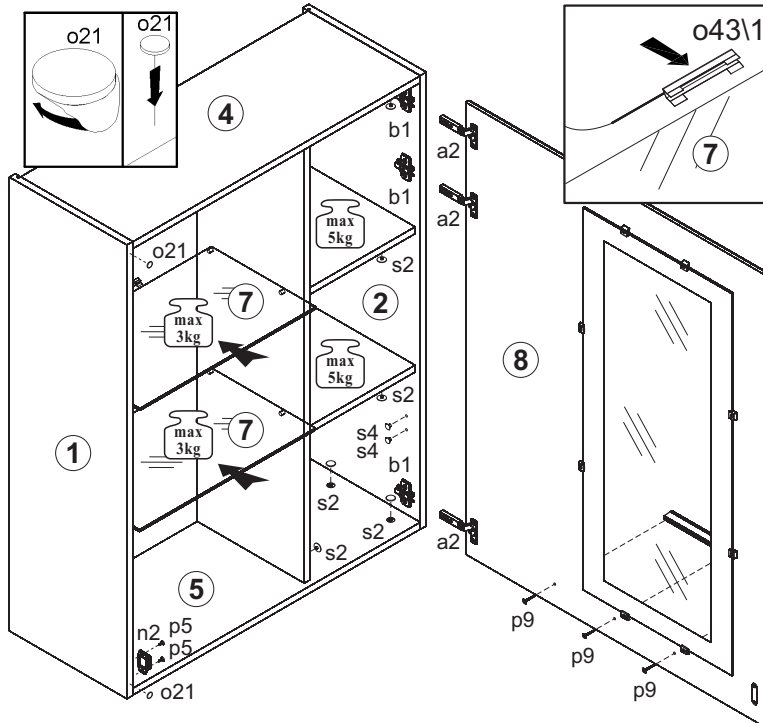
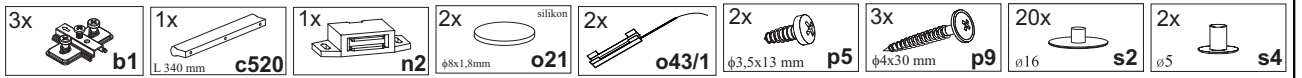

V Полиця / Полка

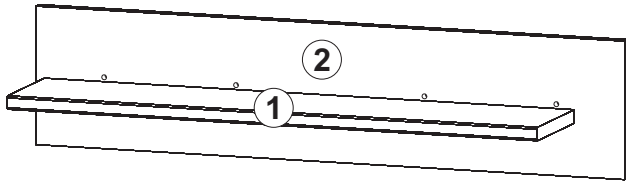

A	B	C	D
1	PU1-306	900	180
2	PU1-401	225	1000



27

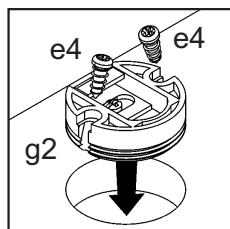
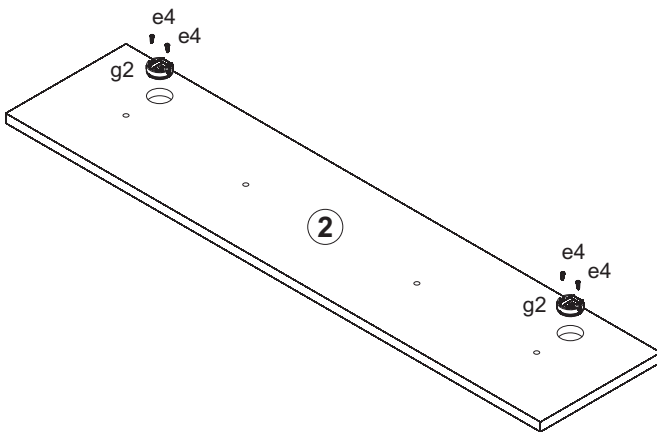
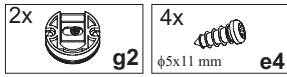

28

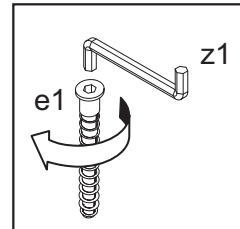
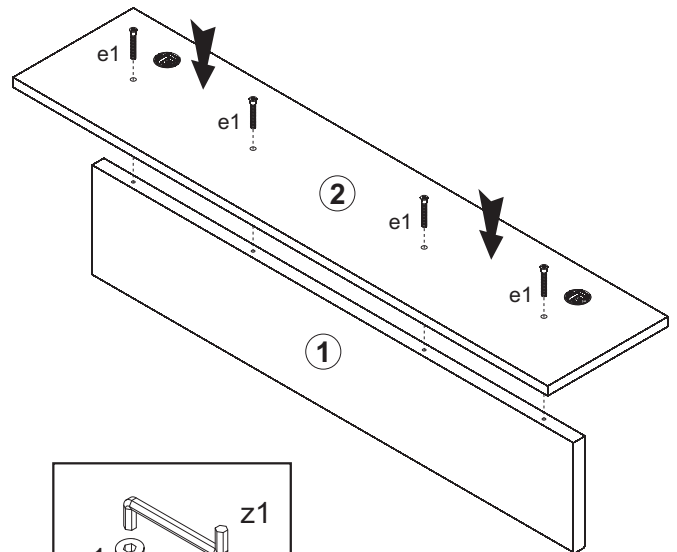
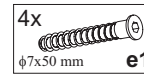

29

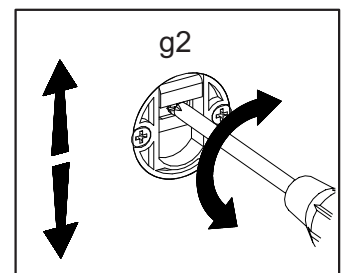
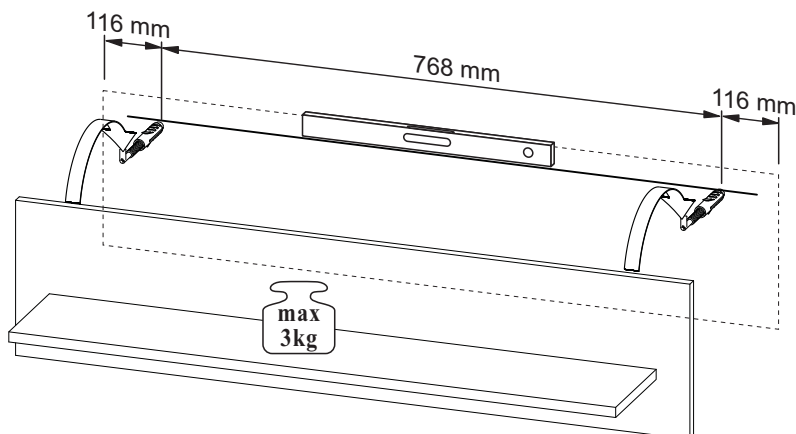
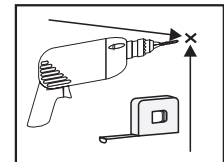
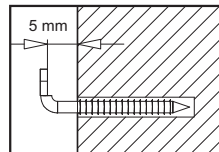
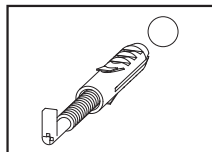
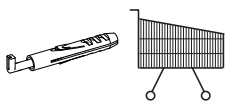

30

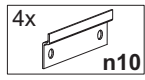

25 mm

62 mm

62 mm

25 mm

