

КАЛІПСО / КАЛИПСО

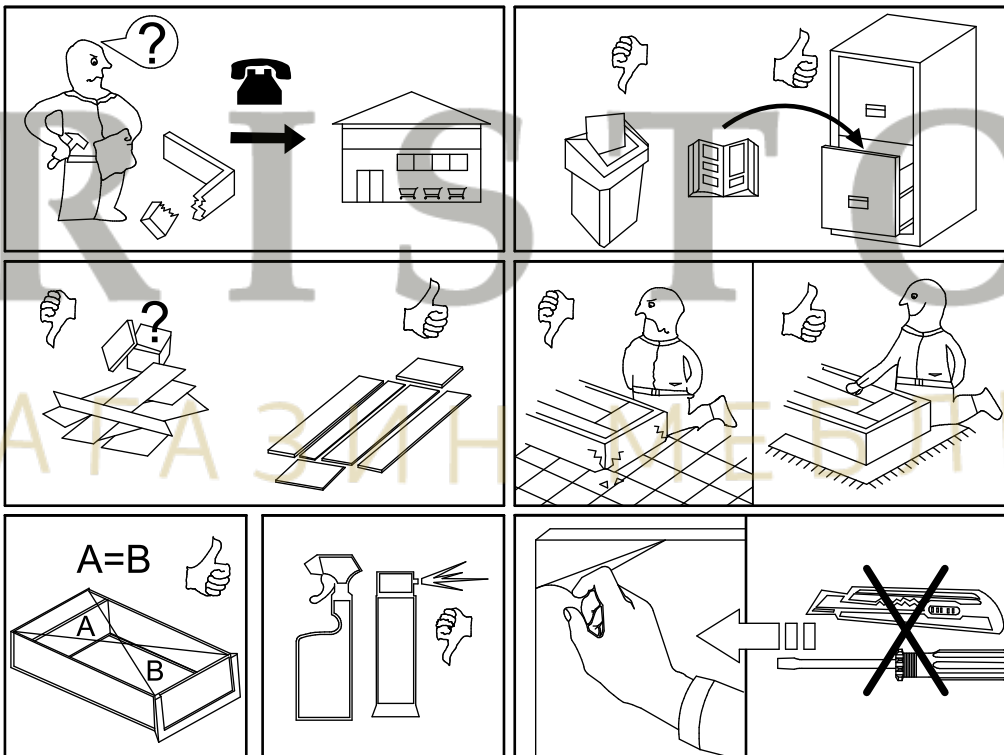

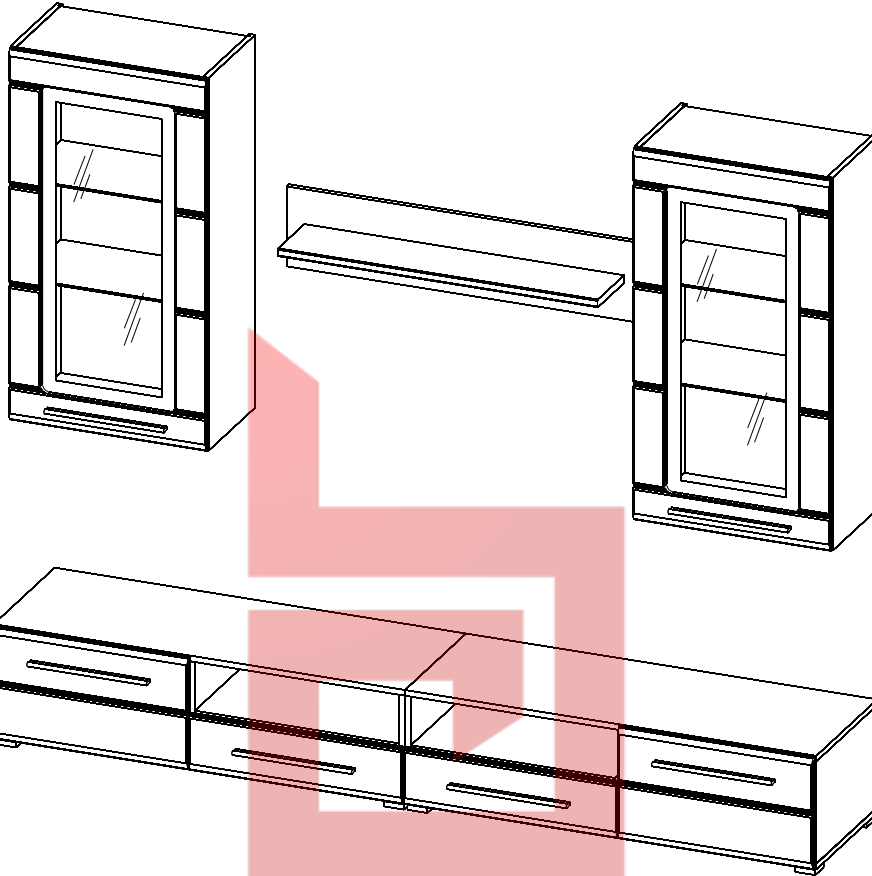

4x K16 a1	6x K0 a2	10x b1	6x L 340 mm c520	16x φ5x17 mm d3	16x φ7x50 mm e1
8x φ6x13 mm e3	4x φ5x11 mm e4	8x φ5x50 mm e32	52x φ8x35 mm f29	2x g2	4x M4x9 mm j2
10x 56x56/20 mm k52	80x l1	20x l2	16x 3 mm l3	2x m48	2x n2
2x 50x12/1,5 mm n3	4x n10	4x n122/1	4x o43/1	1x o43/6	
4x silikon φ8x1,8mm o21	8x φ3,5x13 mm p1	4x φ3,5x13 mm p5	18x φ4x30 mm p9	28x φ4x30 mm p21	16x φ3x16 mm p52
4x φ3x10 mm p100	36x φ15x12mm #16 r1	4x φ12x10,5mm #12 r15	40x 30/11 r23	28x ø16 s2	4x ø5 s4
4x 310 mm w4	1x GLUE y1	1x z1			

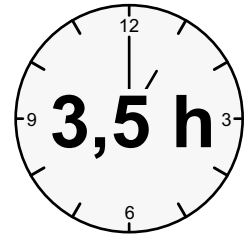
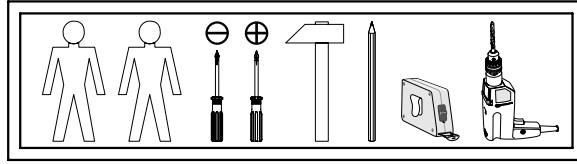
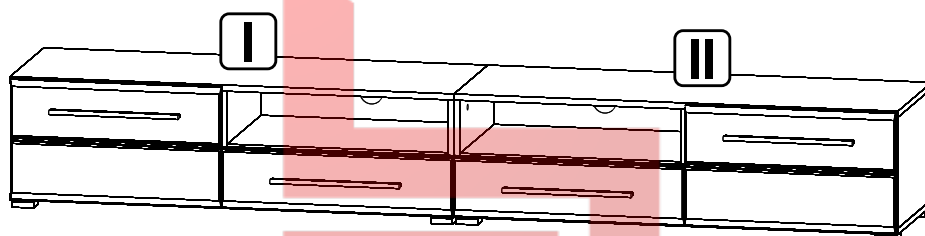
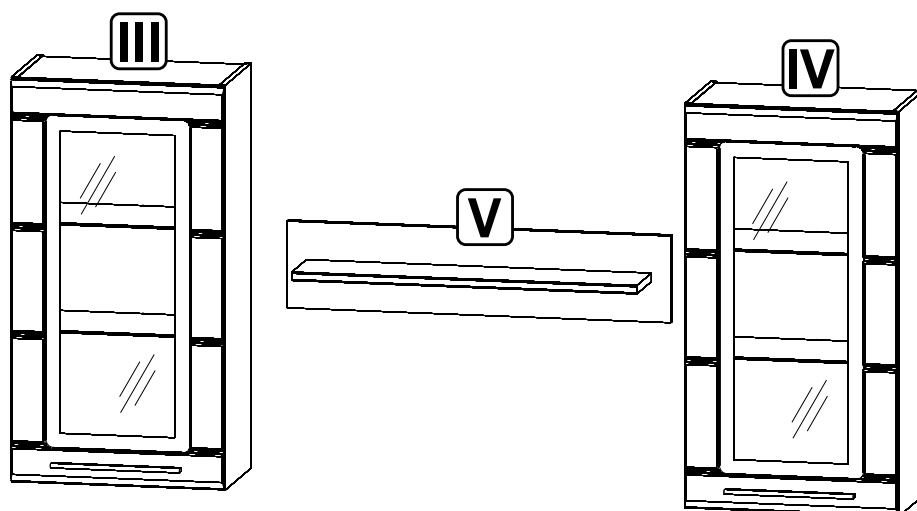

Тумба РТВ ліва / Тумба РТВ левая

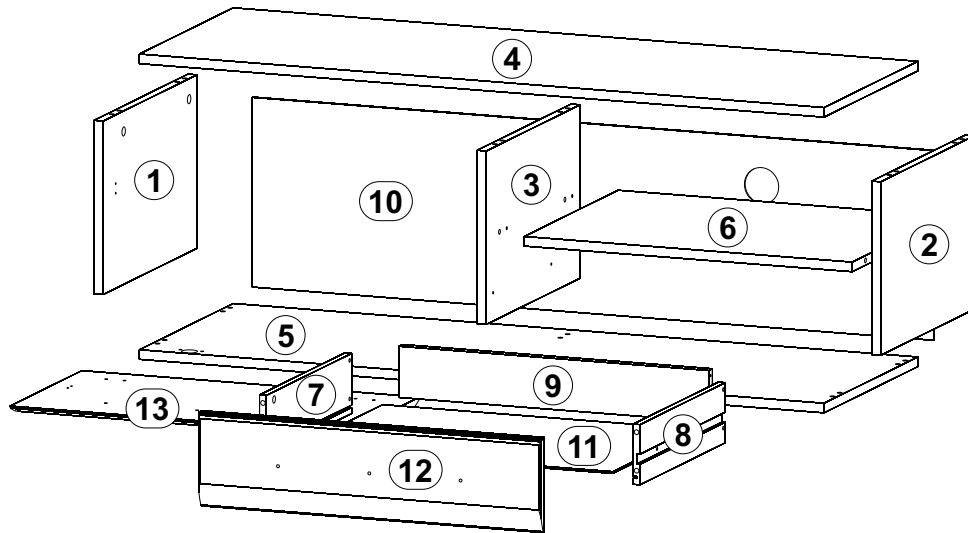





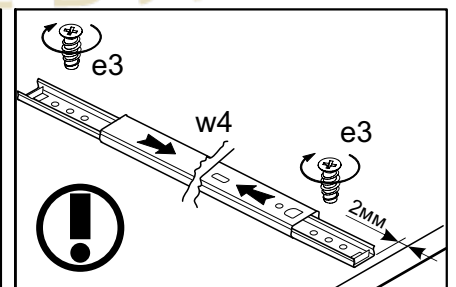
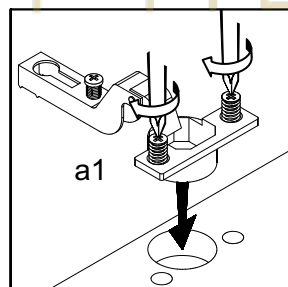
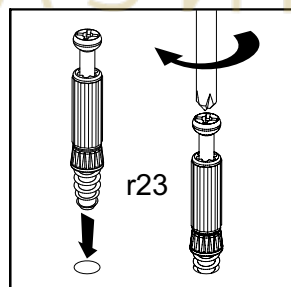
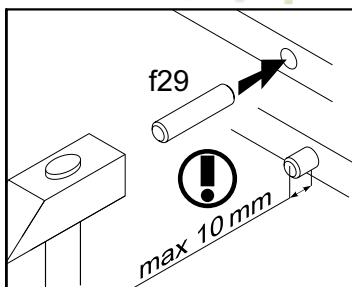
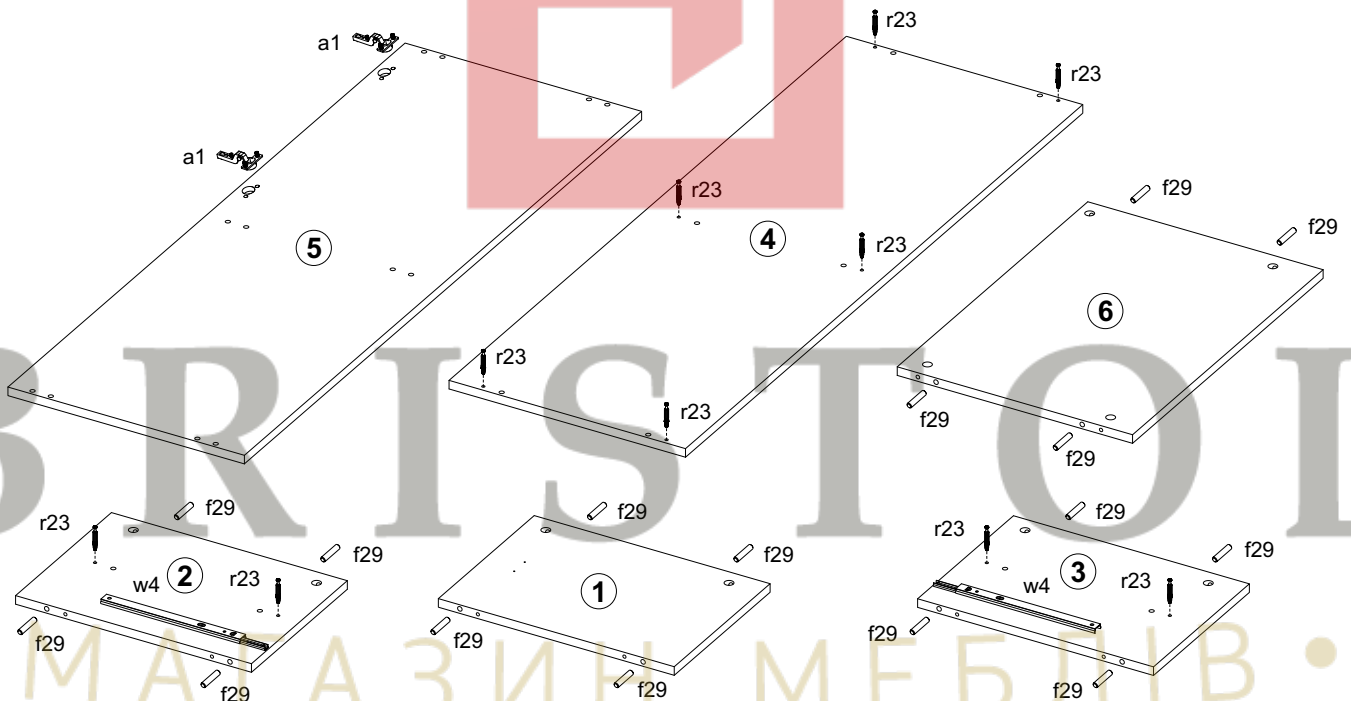
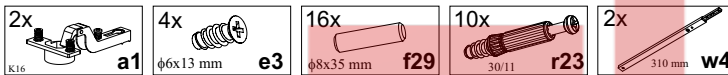

A	B	C	D	A	B	C	D		
1	PU1-101	288	413	1/4	8	PU1-552	375	100	1/4
2	PU1-103	288	413	1/4	9	PU1-553	543	85	1/4
3	PU1-102	288	413	1/4	10	PU1-913	1194	315	1/4
4	PU1-212	1200	413	1/4	11	PU1-904	554	378	1/4
5	PU1-213	1200	413	1/4	12	PU1-003A	600	158	4/4
6	PU1-301	575	413	1/4	13	PU1-014A	592	316	4/4
7	PU1-551	375	100	1/4					

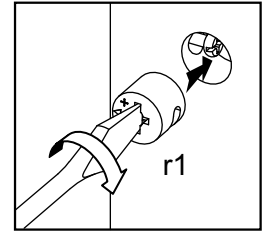
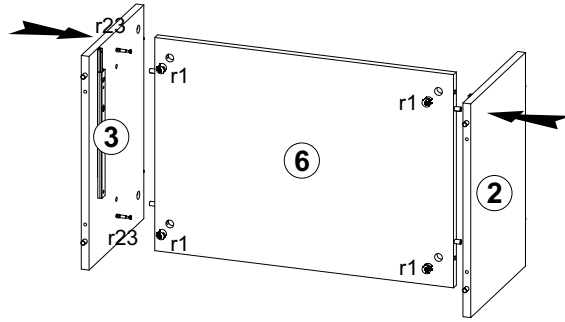

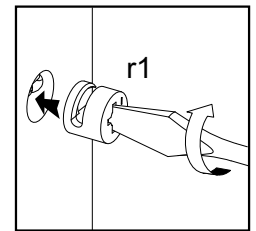
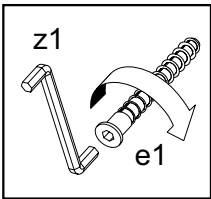
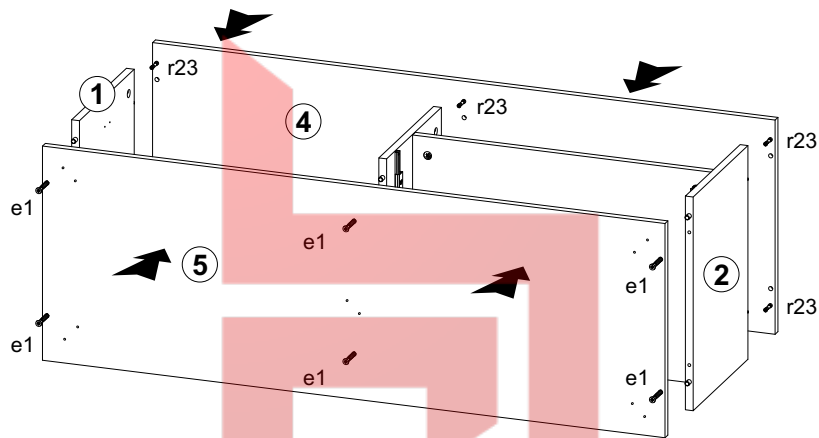
1

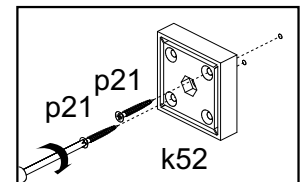
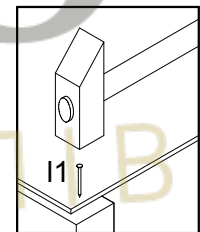
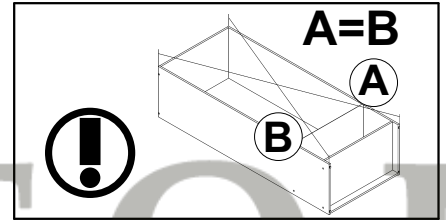
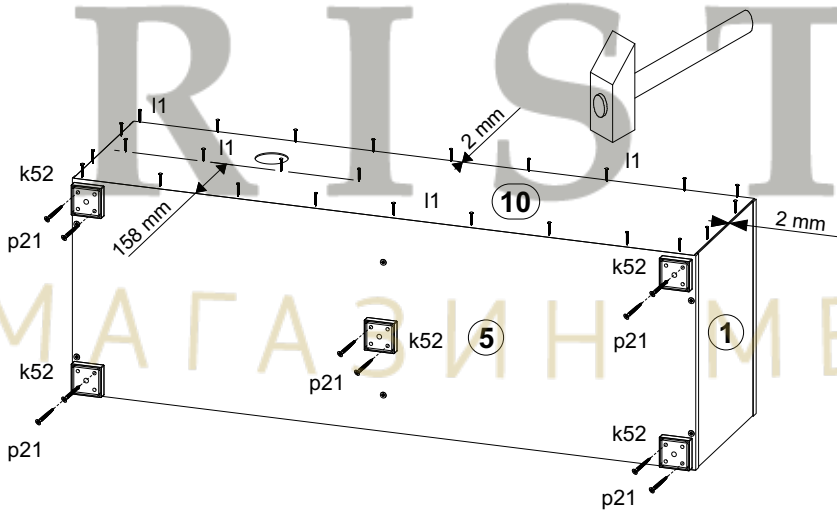

24x  $\phi 15 \times 12 \text{ mm}$ #16 **r1****3**6x  $\phi 7 \times 50 \text{ mm}$ **e1**6x  $\phi 15 \times 12 \text{ mm}$ #16 **r1**1x  **z1****4**36x  **l1**5x  $56 \times 56 \times 20 \text{ mm}$ **k52**10x  $\phi 4 \times 30 \text{ mm}$ **p21**

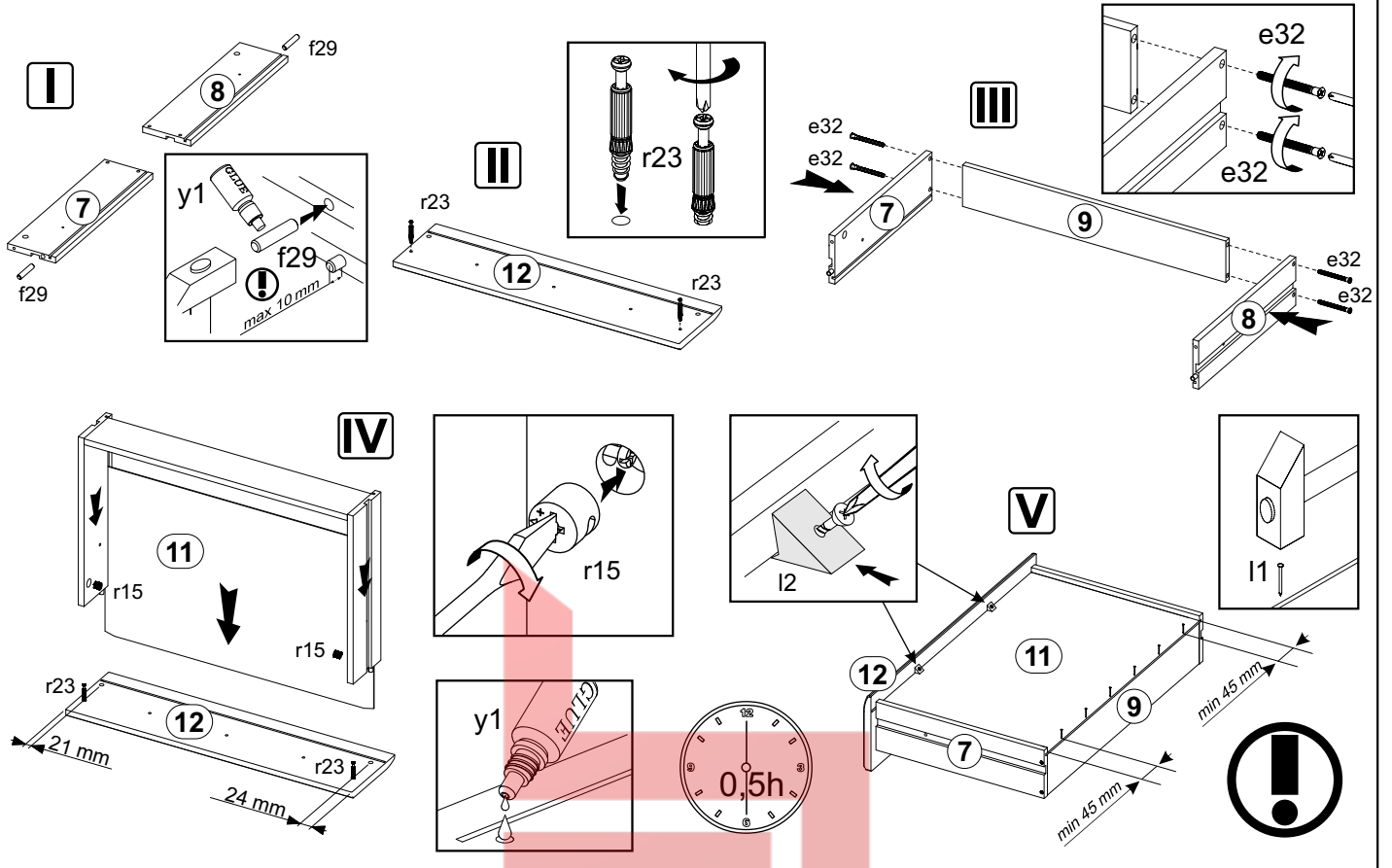
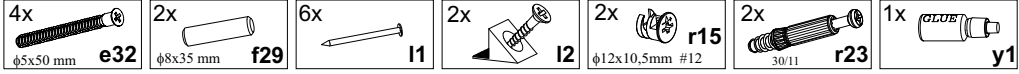
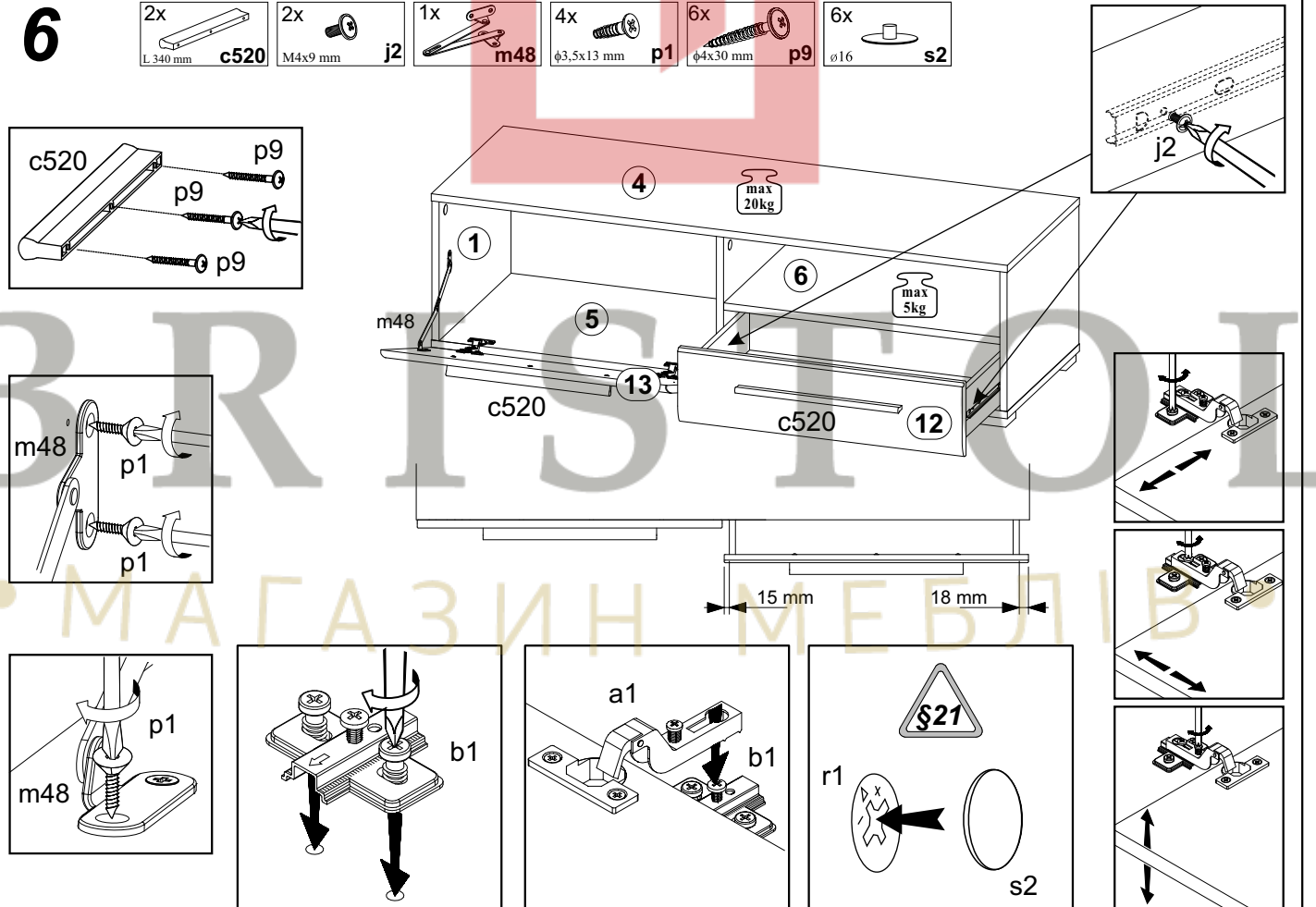
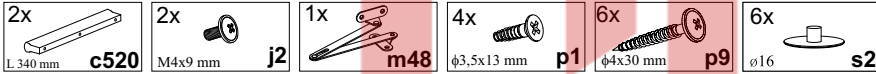
5**6**



Тумба РТВ права / Тумба РТВ правая

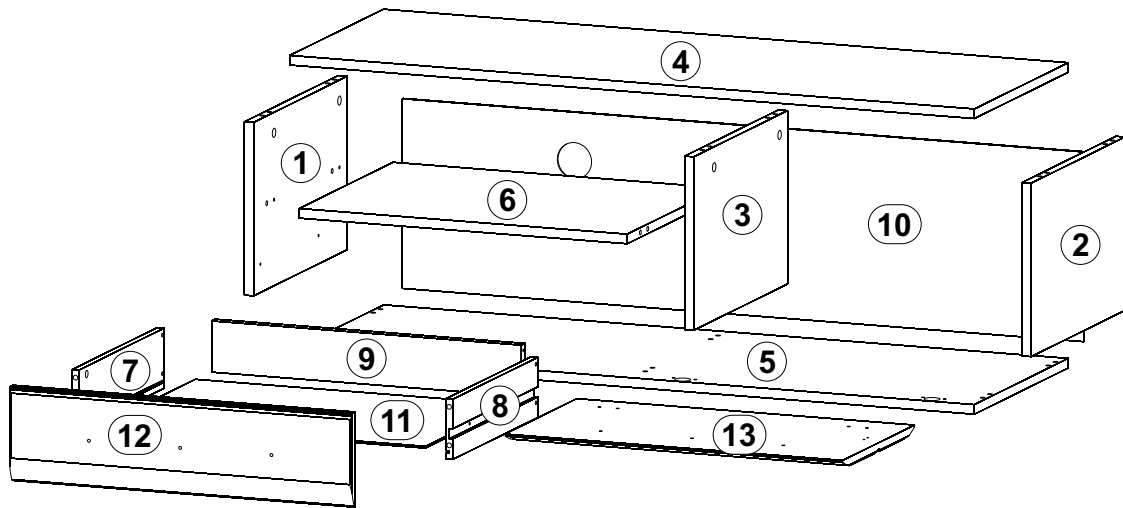







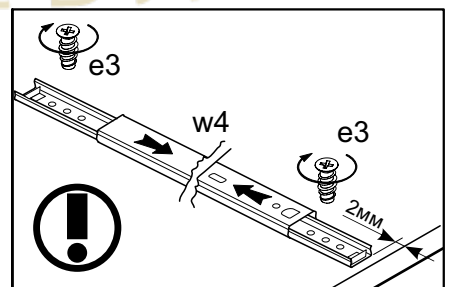
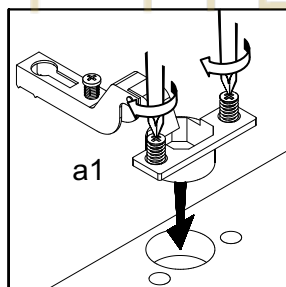
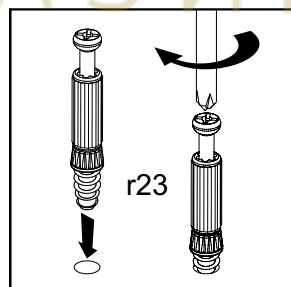
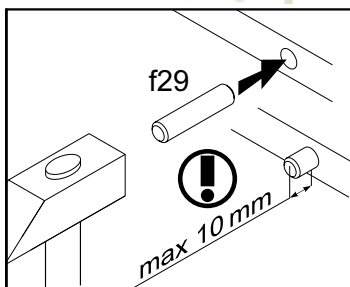
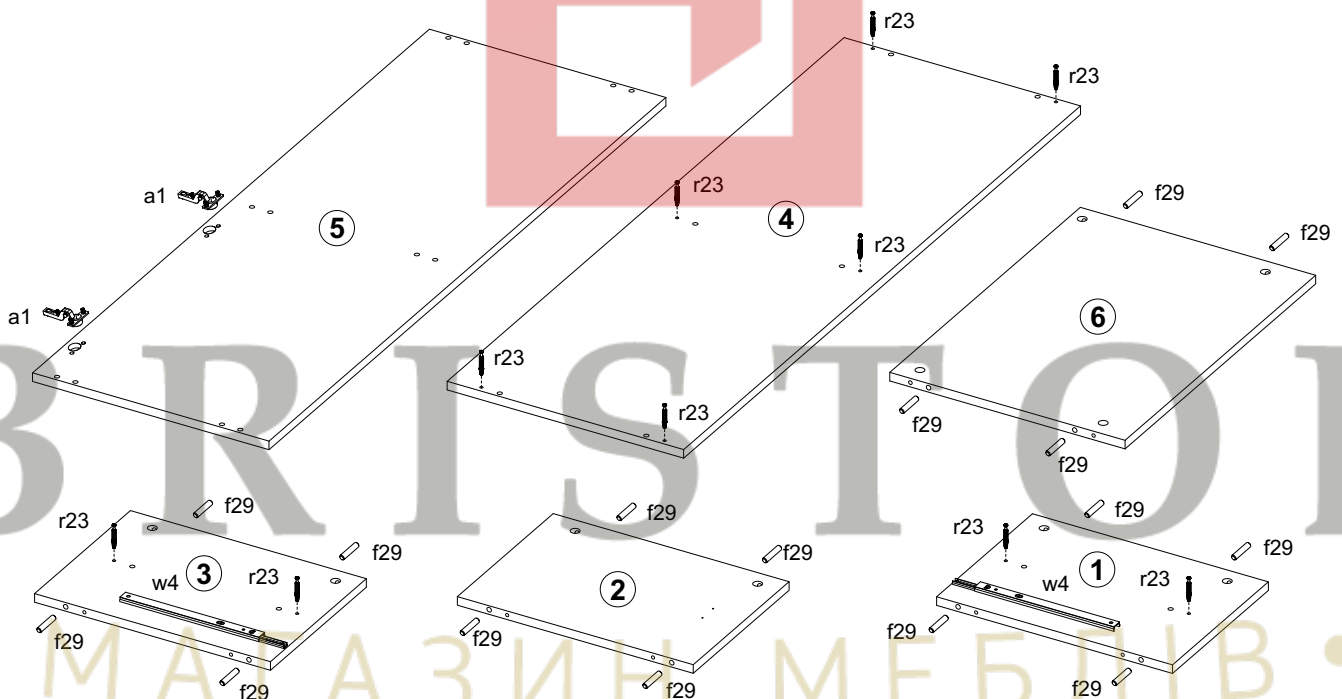
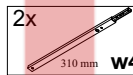
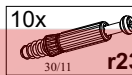
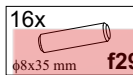
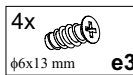
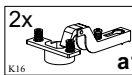

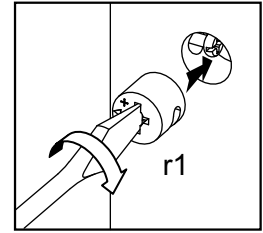
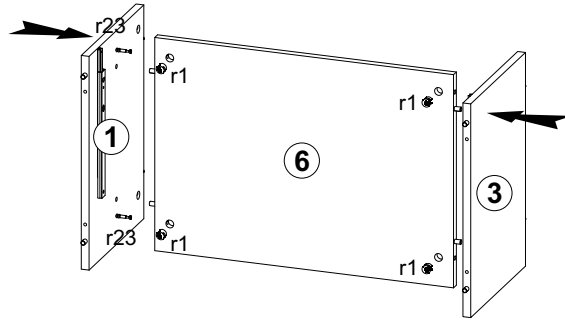
A	B	C	D	A	B	C	D		
1	PU1-104	288	413	2/4	8	PU1-552	375	100	2/4
2	PU1-106	288	413	2/4	9	PU1-553	543	85	2/4
3	PU1-105	288	413	2/4	10	PU1-914	1194	315	2/4
4	PU1-214	1200	413	2/4	11	PU1-904	554	378	2/4
5	PU1-215	1200	413	2/4	12	PU1-005A	600	158	4/4
6	PU1-301	575	413	2/4	13	PU1-015A	592	316	4/4
7	PU1-551	375	100	2/4					

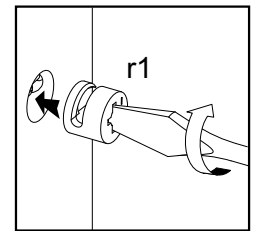
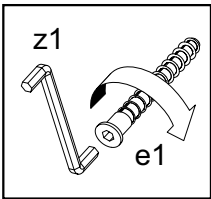
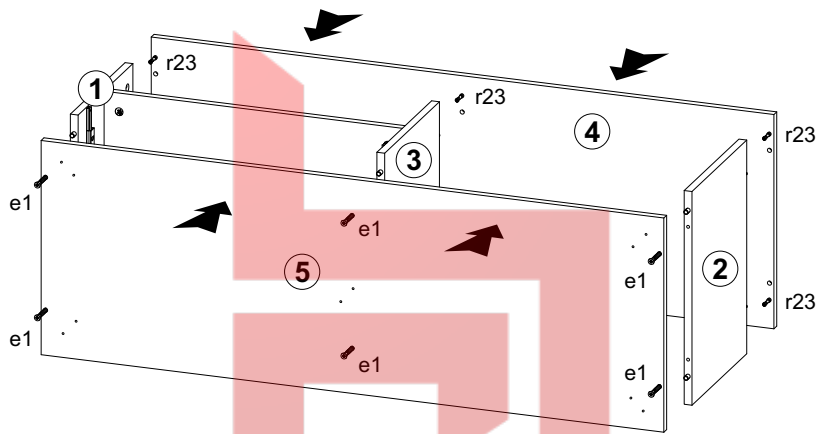

7

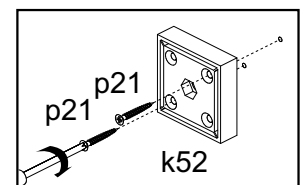
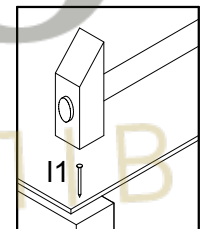
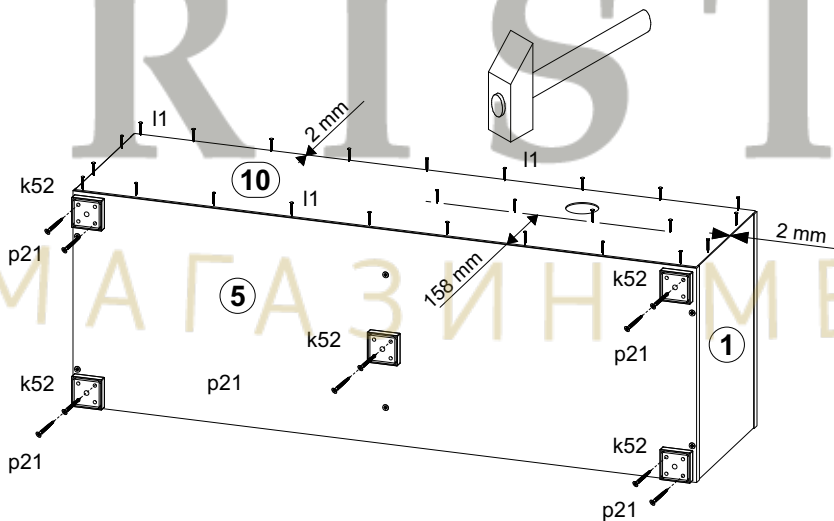
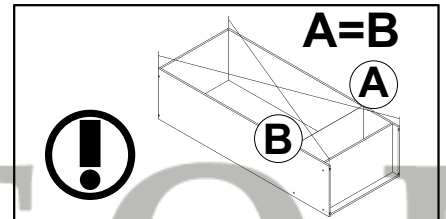

84x  $\phi 15 \times 12 \text{ mm}$ #16 r1**9**6x  $\phi 7 \times 50 \text{ mm}$ e16x  $\phi 15 \times 12 \text{ mm}$ #16 r11x  z1**10**36x  l15x  56x56/20 mm k5210x  $\phi 4 \times 30 \text{ mm}$ p21

11

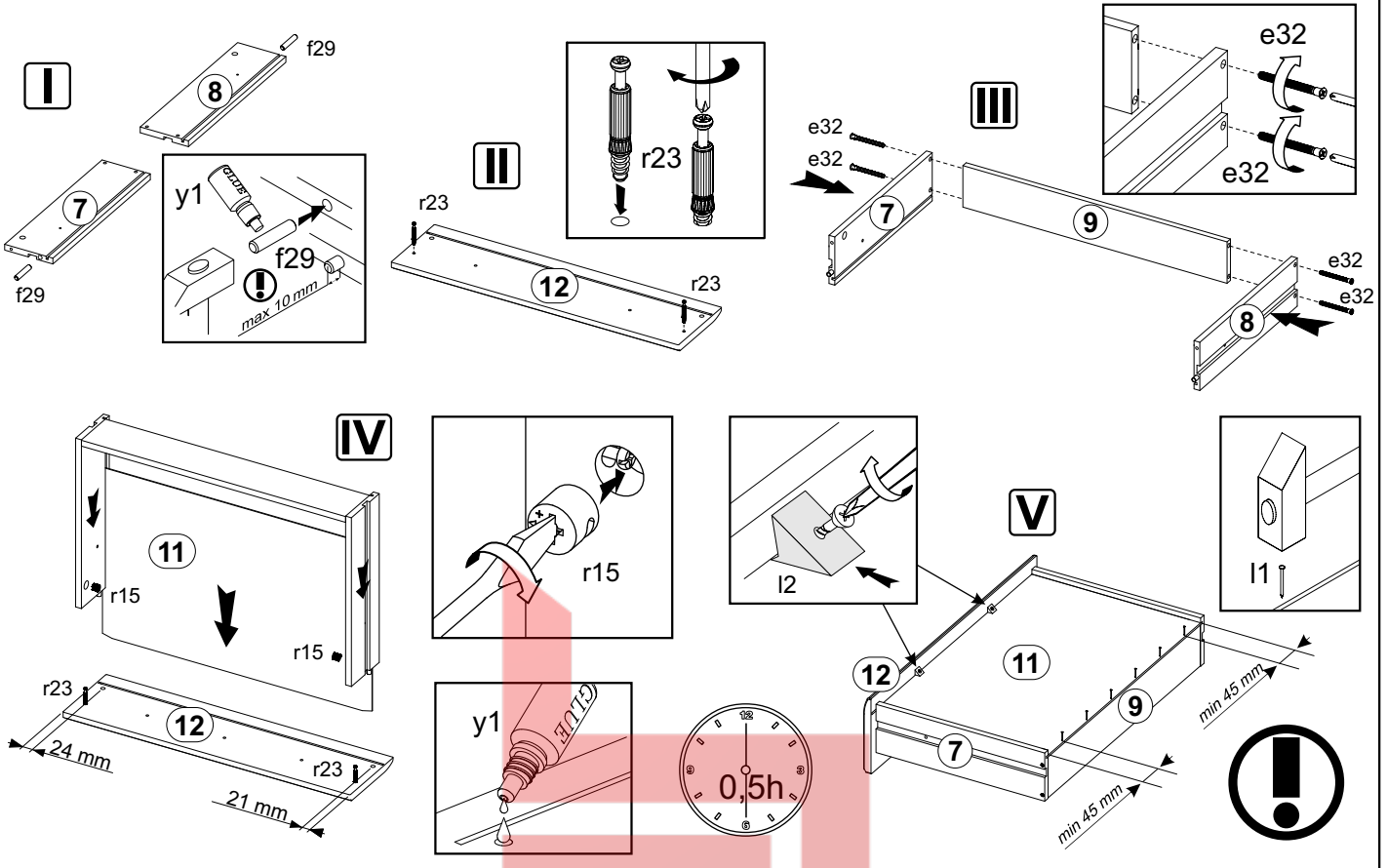
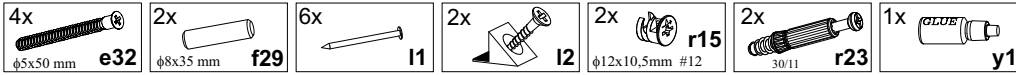

12

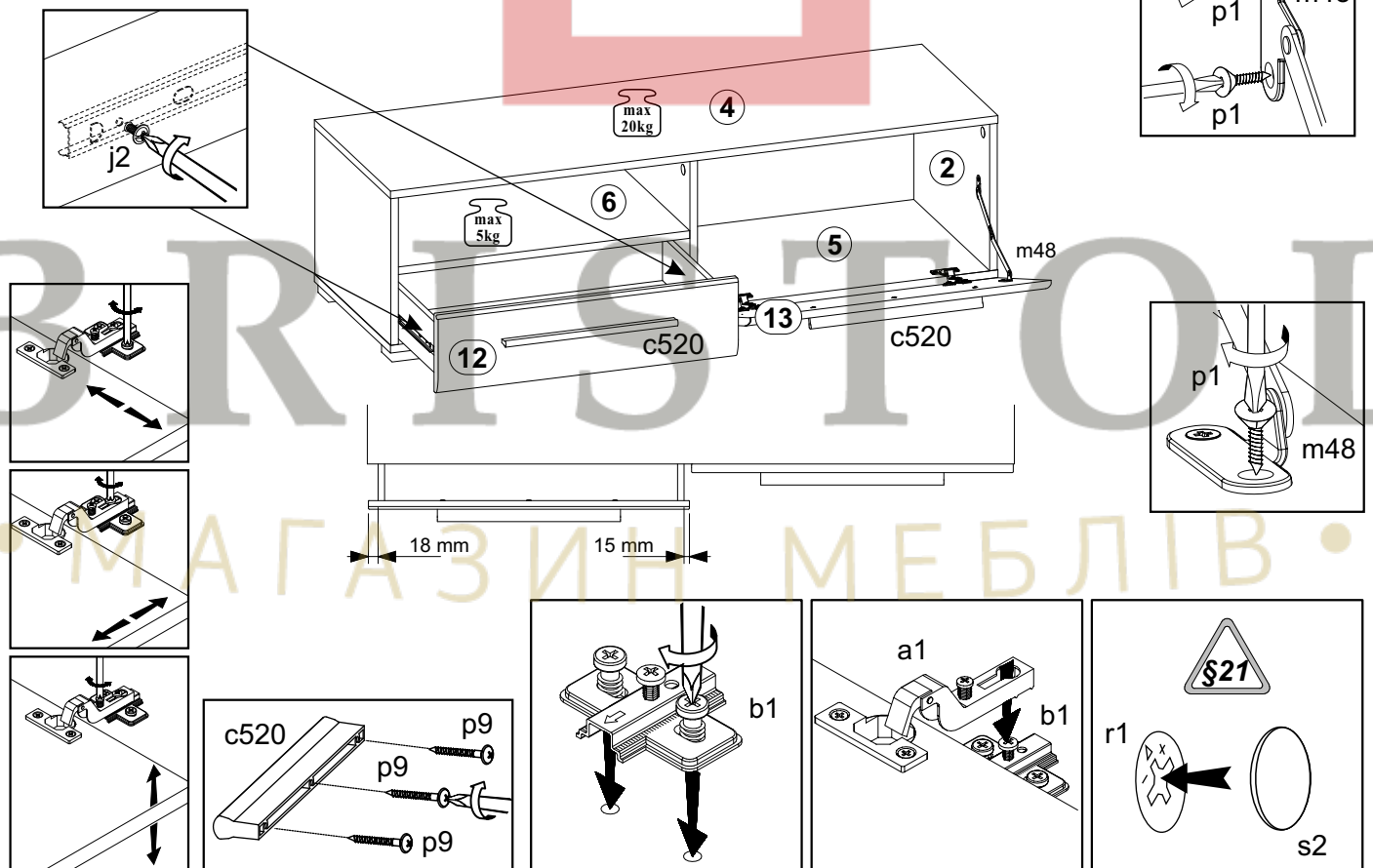
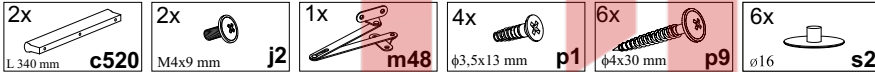



Вітрина навісна ліва / Витрина навесная левая

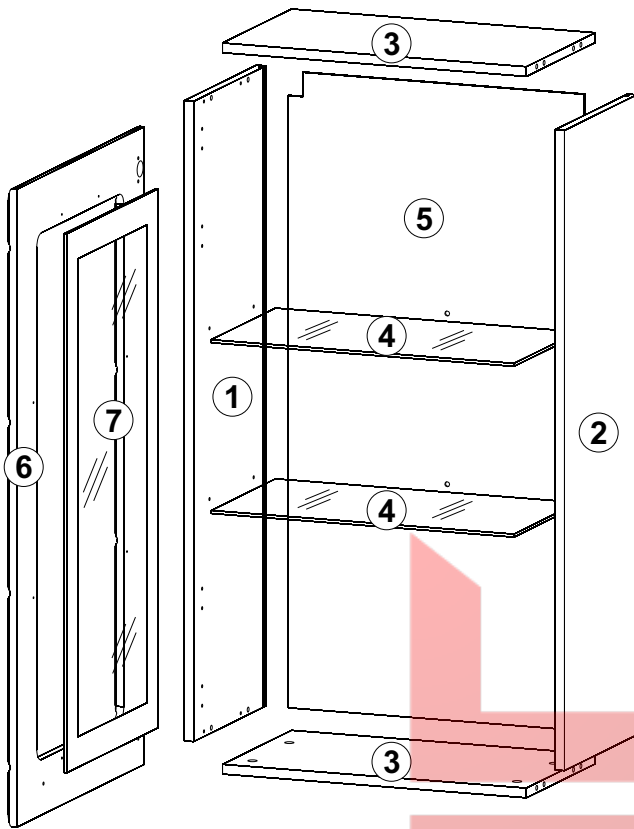

A	B	C	D	
1	PU1-113-01	1050	314	3/4
2	PU1-108-01	1050	314	3/4
3	PU1-309	568	300	3/4
4	PU1-310	565	279	3/4
5	PU1-912	1044	579	4/4
6	PU1-012A	1046	596	4/4
7	PU1-501	884	398	4/4

13

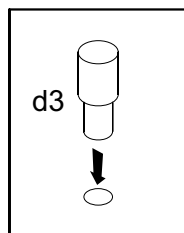
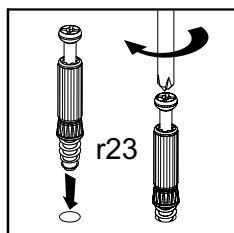
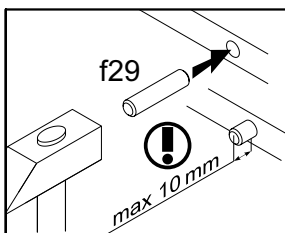
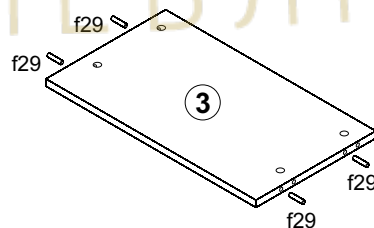
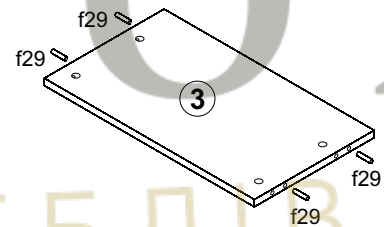
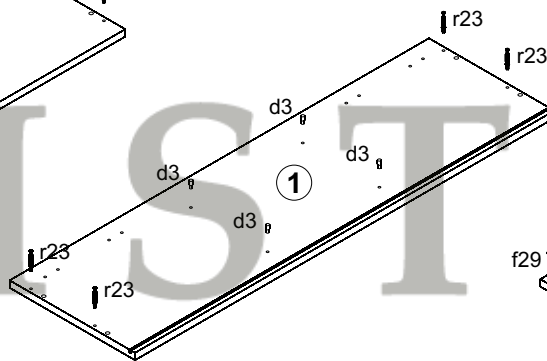
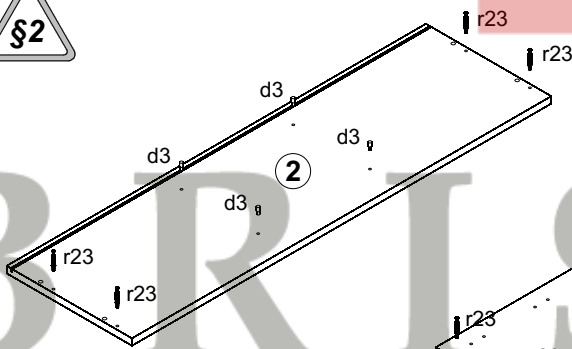
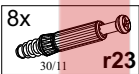
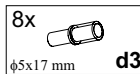
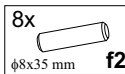

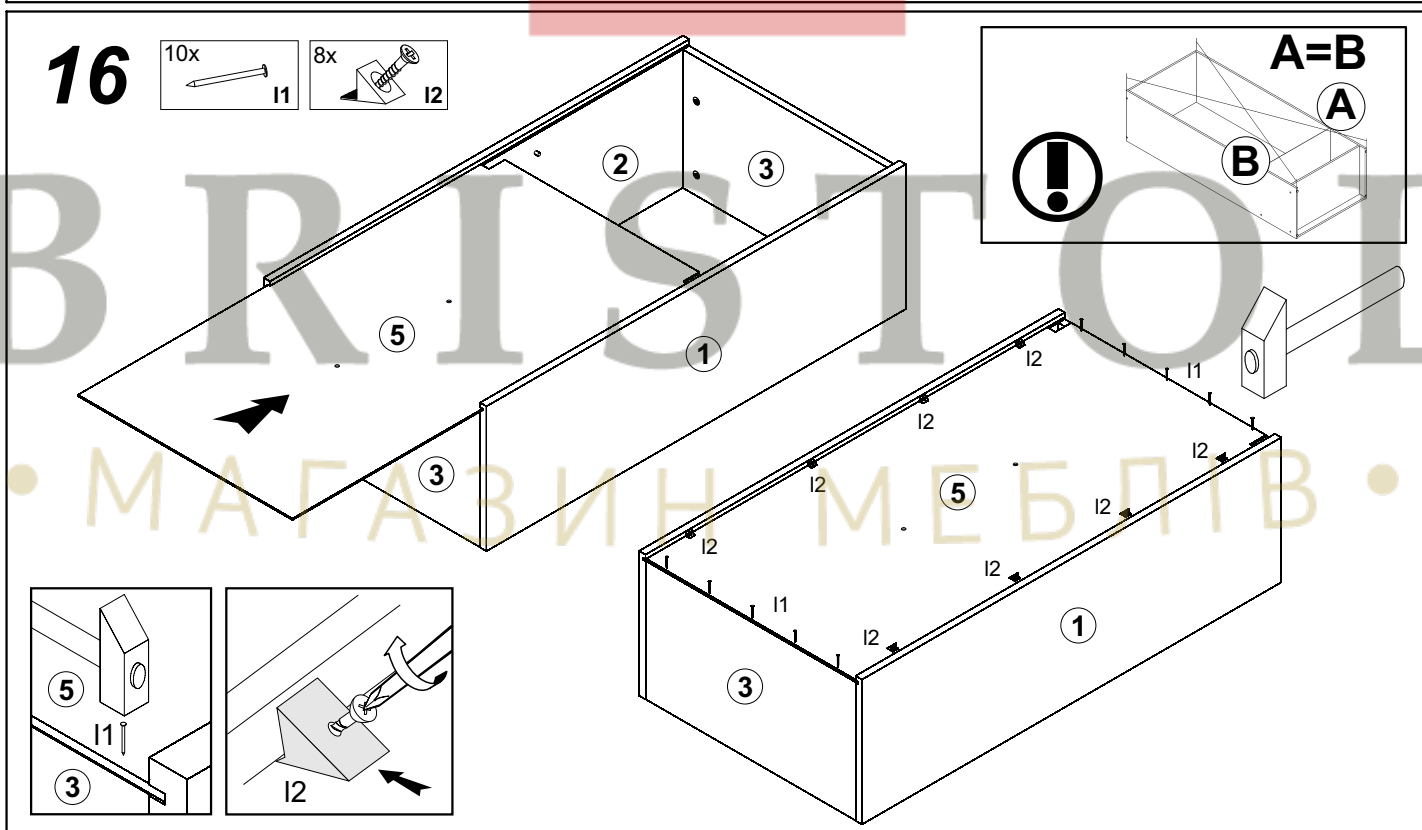
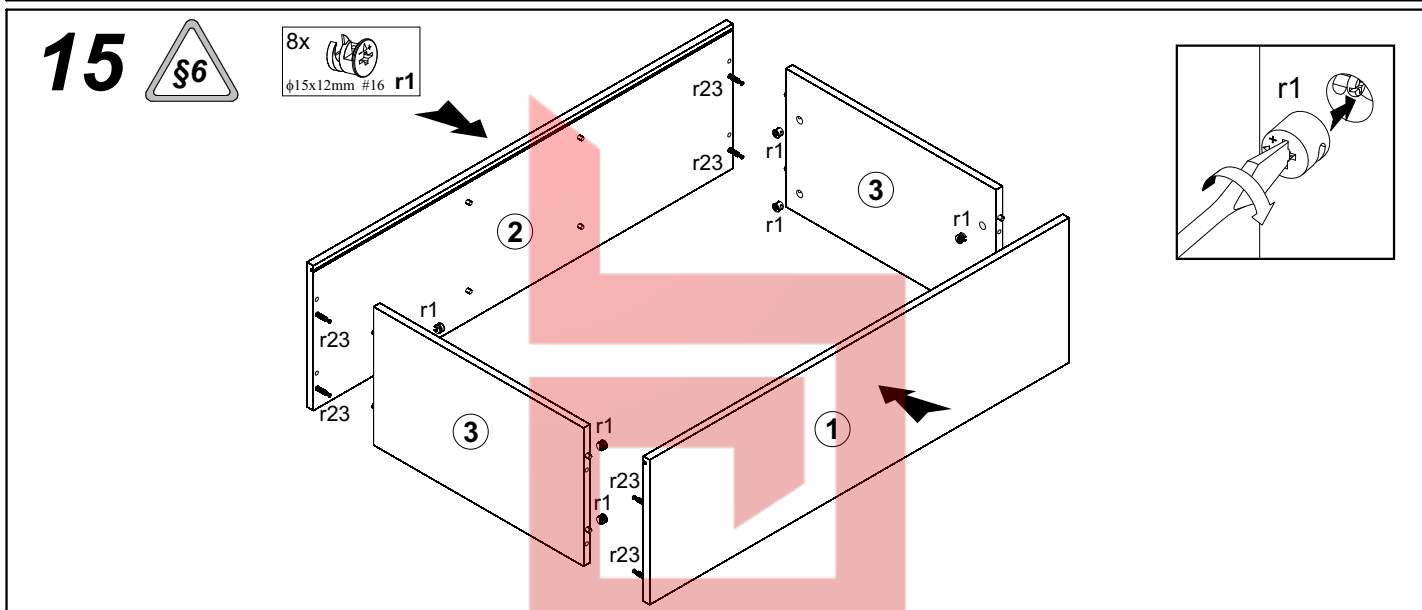
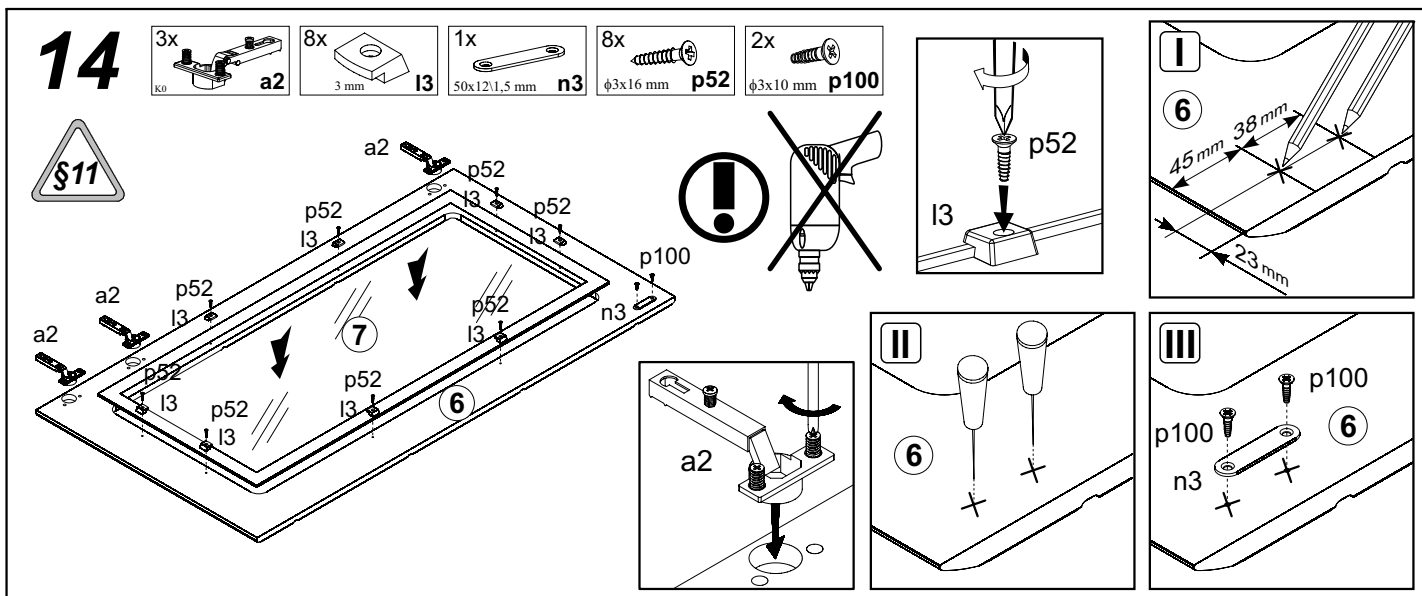

17

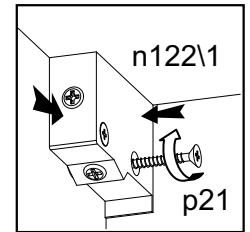
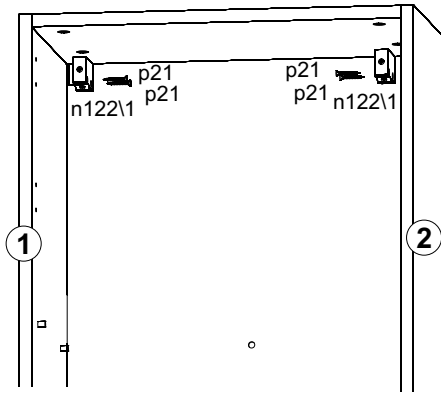
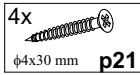
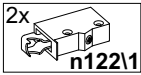

18

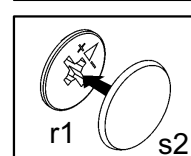
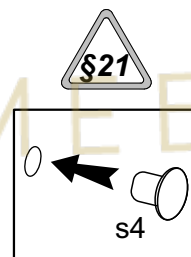
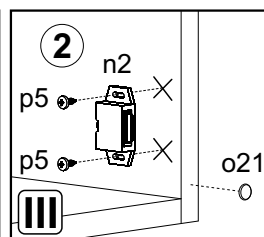
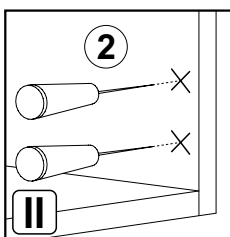
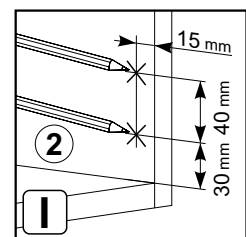
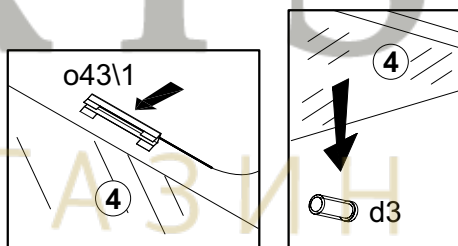
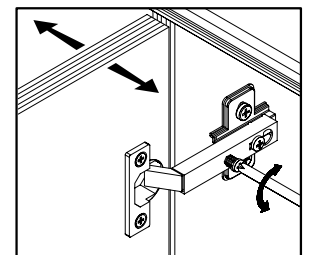
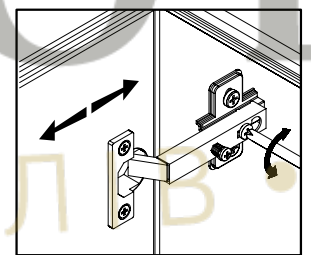
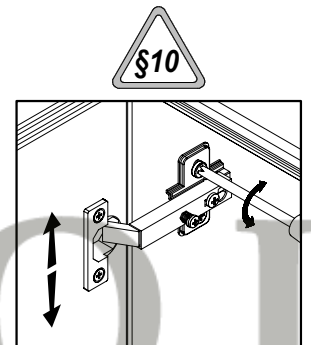
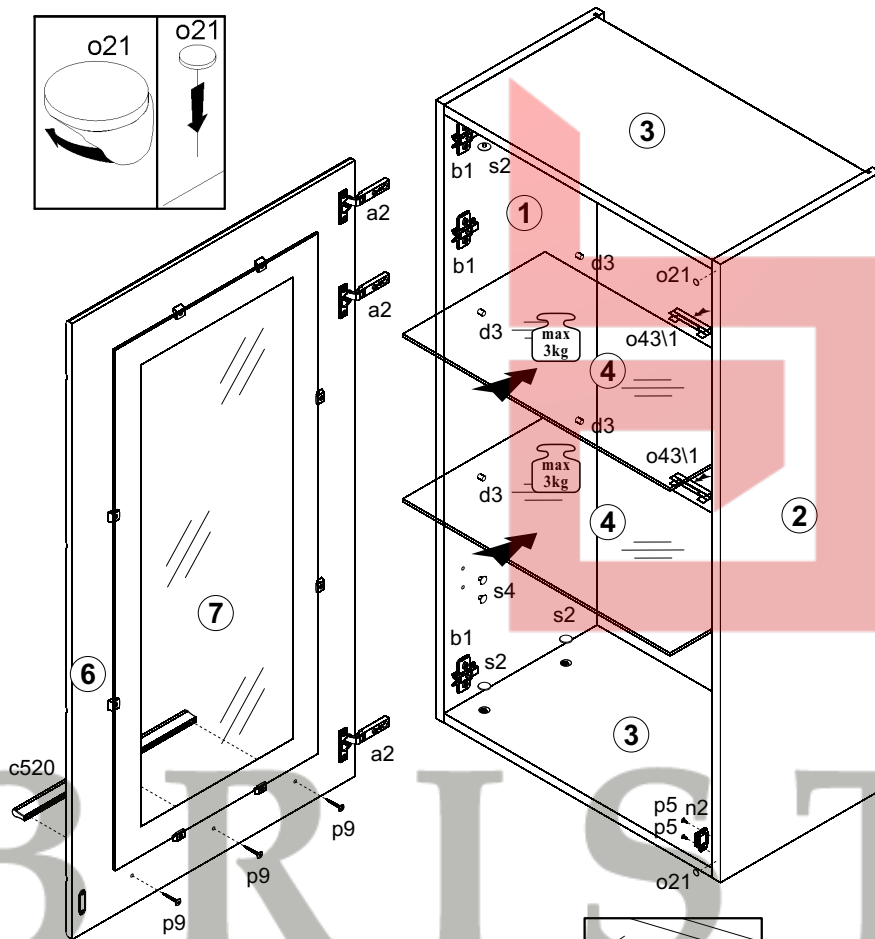
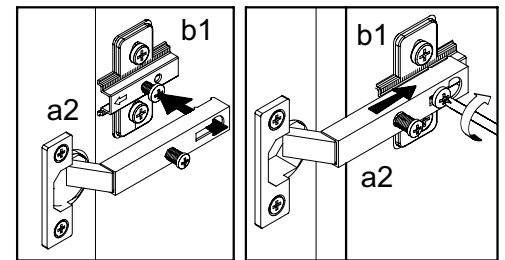
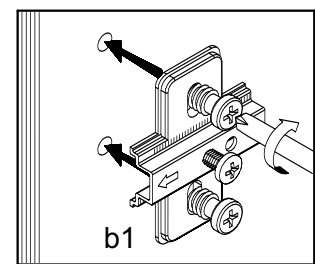
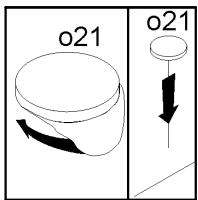
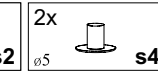
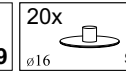
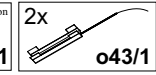
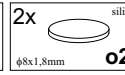
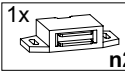
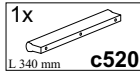

IV

Вітрина навісна права / Витрина навесная правая

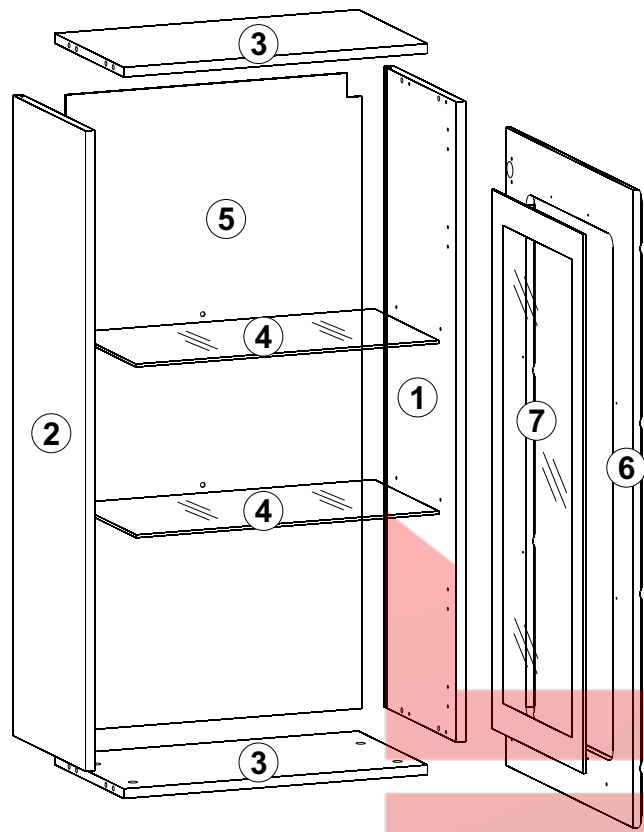

A	B	C	D
1	PU1-113-01	1050	314 3/4
2	PU1-108-01	1050	314 3/4
3	PU1-309	568	300 3/4
4	PU1-310	565	279 3/4
5	PU1-912	1044	579 4/4
6	PU1-013A	1046	596 4/4
7	PU1-501	884	398 4/4

19

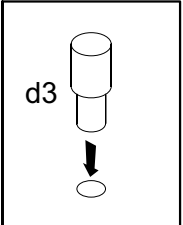
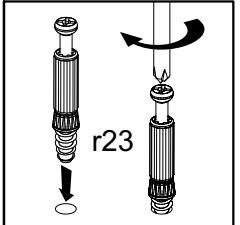
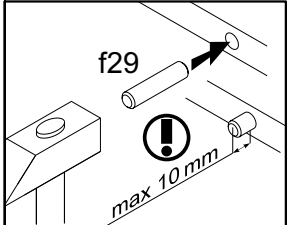
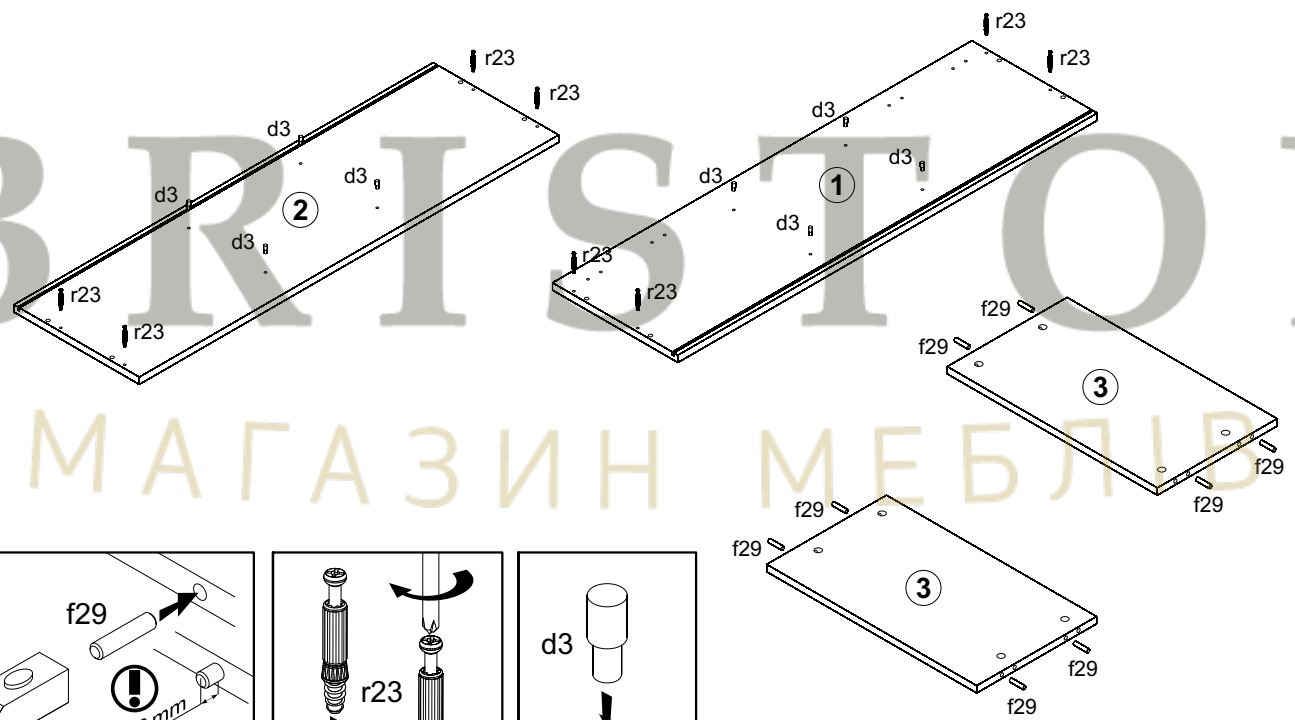
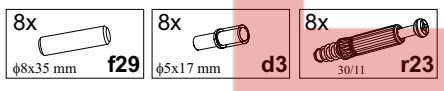

20

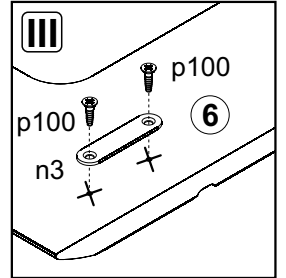
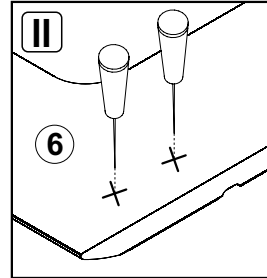
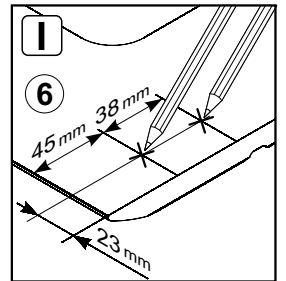
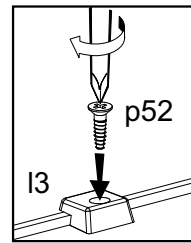
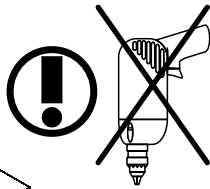
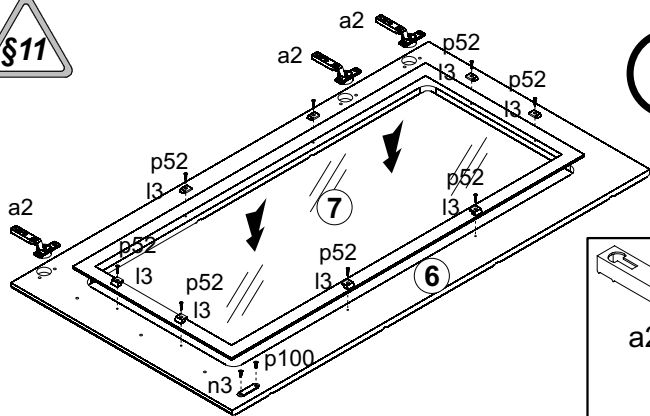
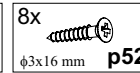
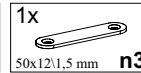
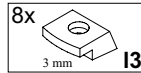
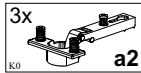

21

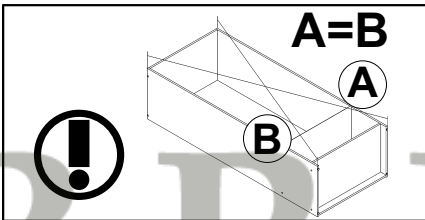
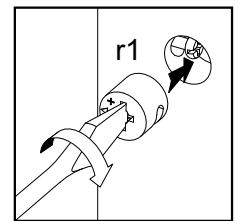
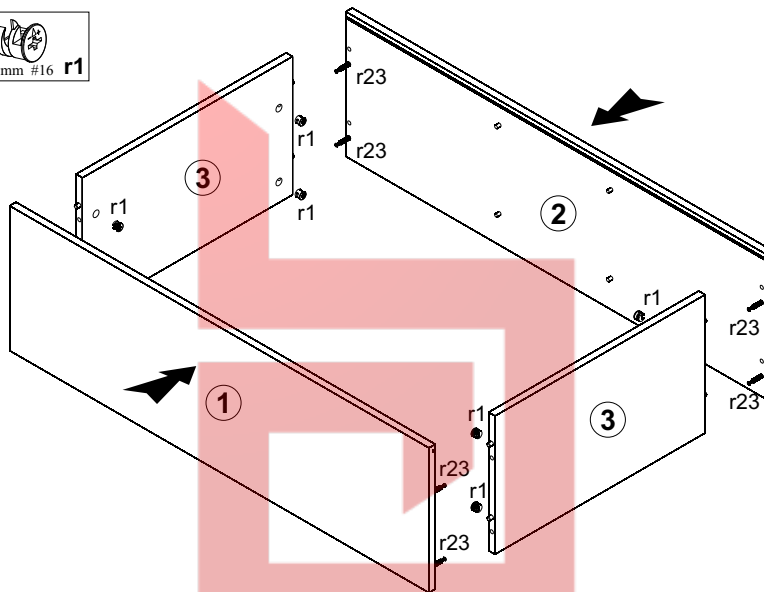
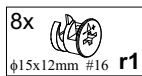

22

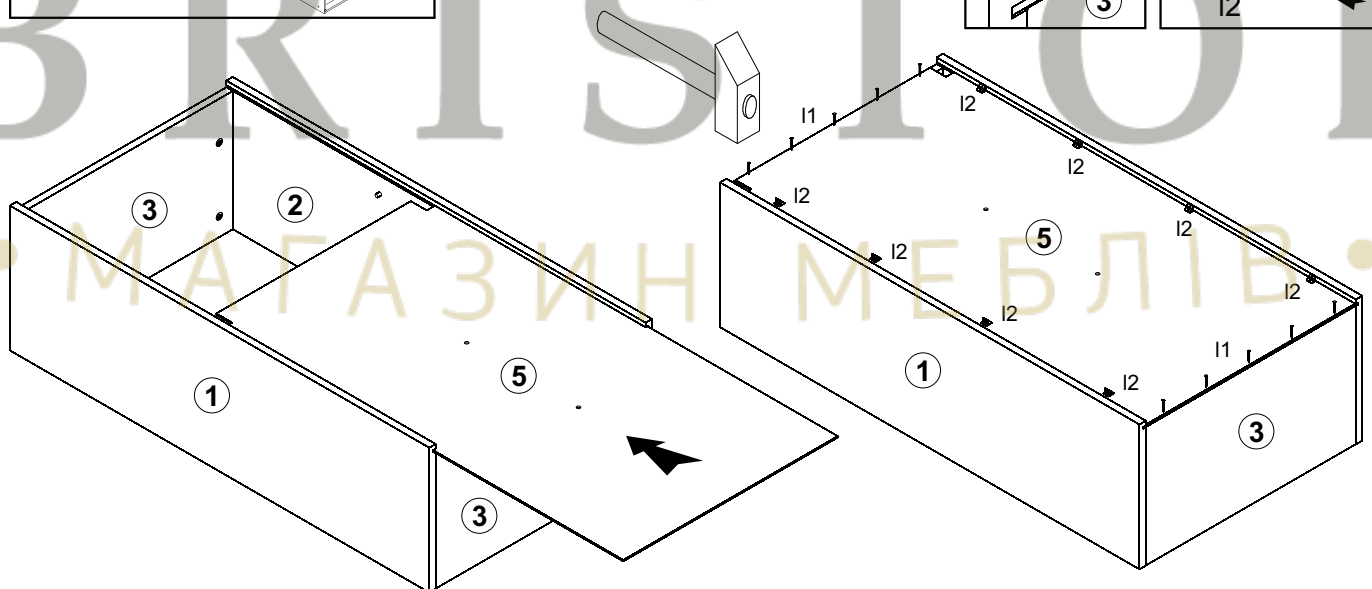
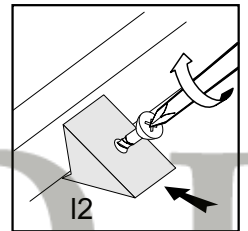
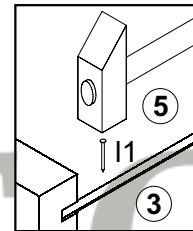
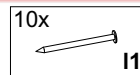

23

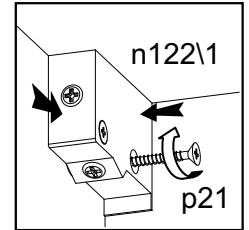
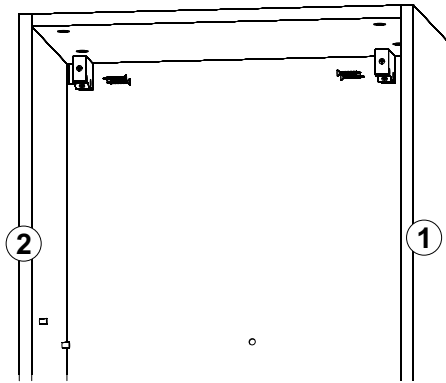
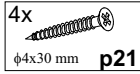
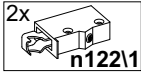

24

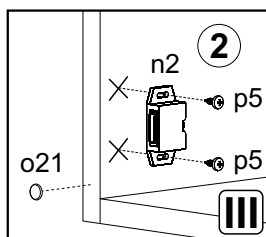
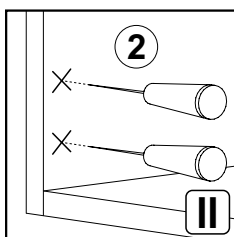
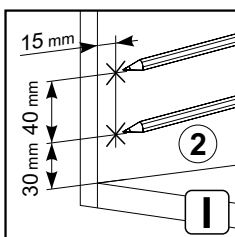
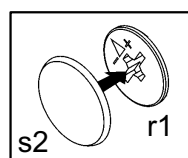
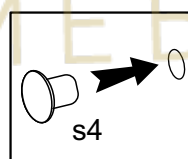
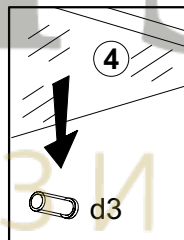
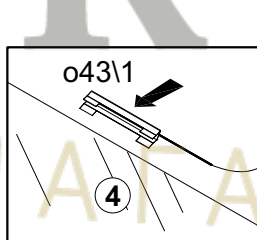
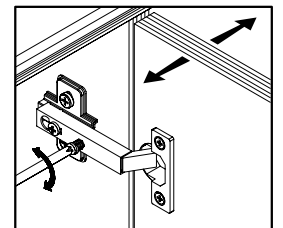
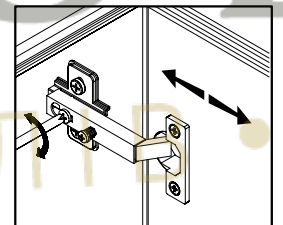
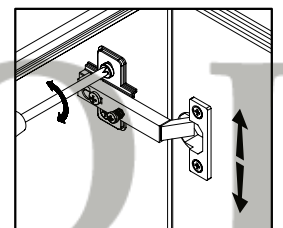
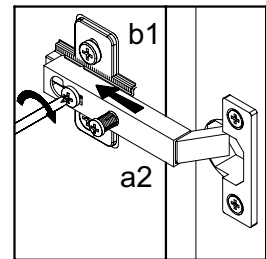
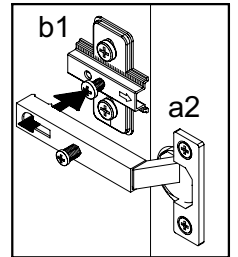
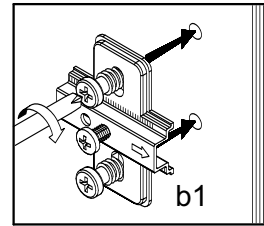
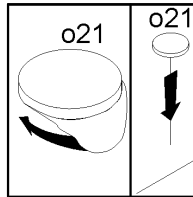
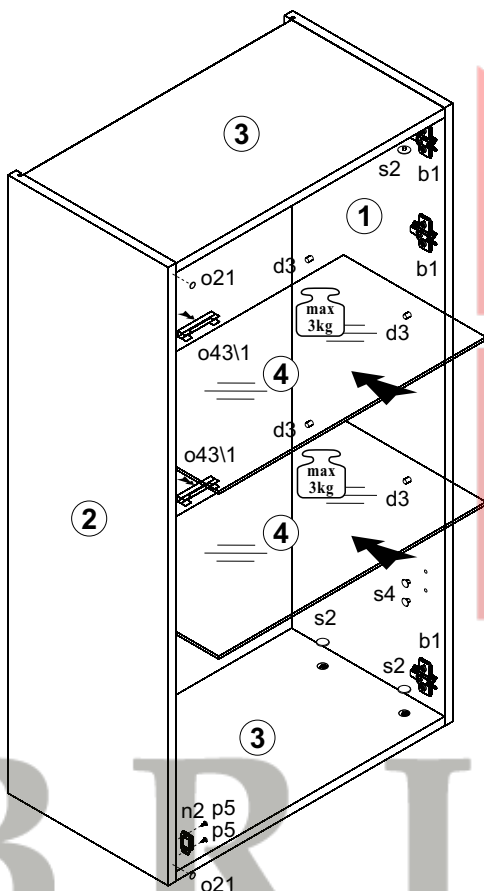
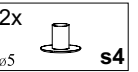
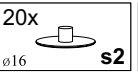
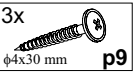
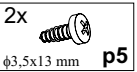
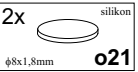
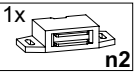
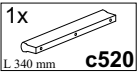

V Полиця / Полка

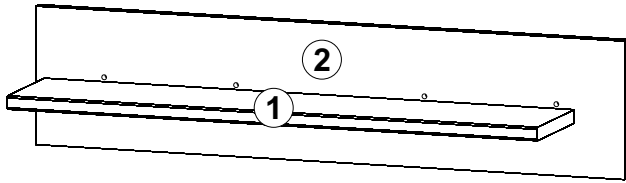

A	B	C	D
1	PU1-306	900	180
2	PU1-401	225	1000



25

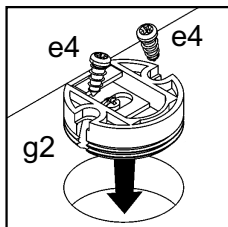
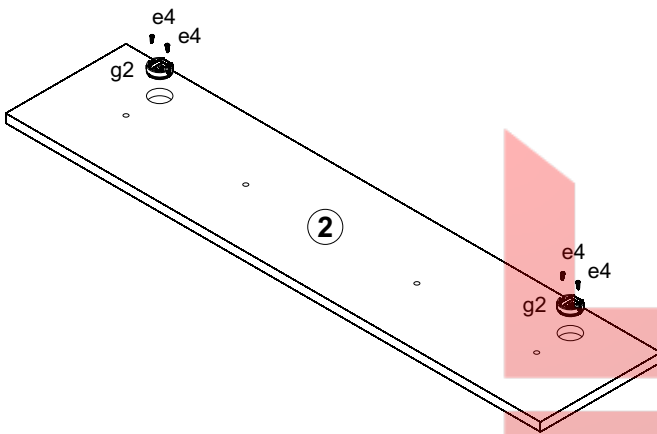
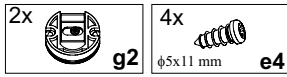

26

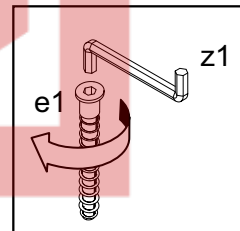
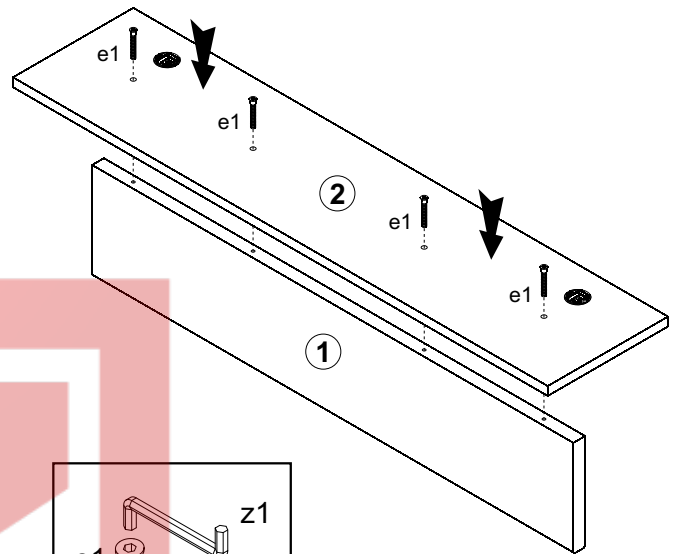
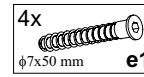

27

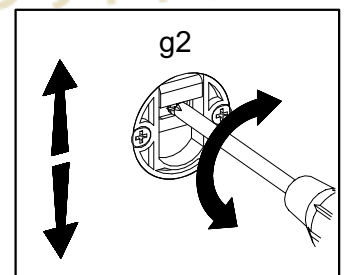
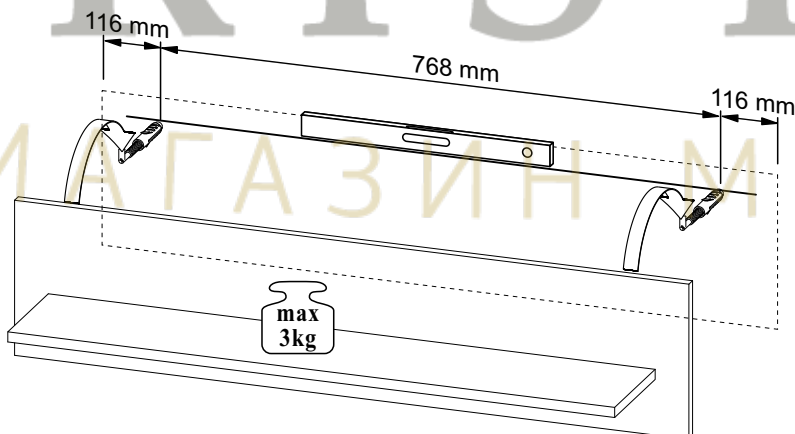
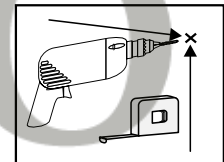
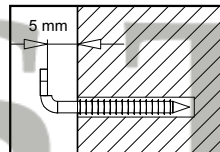
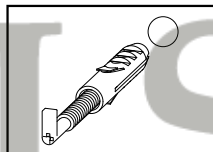

28

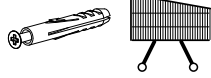
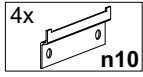

25 mm

64 mm

64 mm

25 mm

