

МОДЕН

Надставка **NAD2D/120**

A	B	C		D
1	S321-113	1718	355	1/2
2	S321-114	1718	355	1/2
3	S321-117	788	354	1/2
4	S321-301	1166	354	1/2
5	S321-319	1166	354	1/2
6	S321-320	575	354	1/2
7	S321-321	575	345	1/2
8	S321-419	1166	68	1/2
9	S321-919	872	596	1/2
10	S321-918	809	596	1/2
11	LH-828	828		1/2
12	S321-008	596	530	2/2

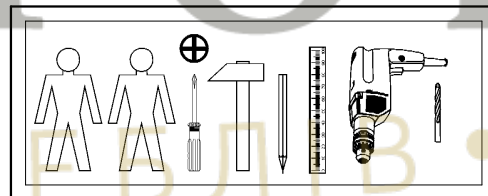
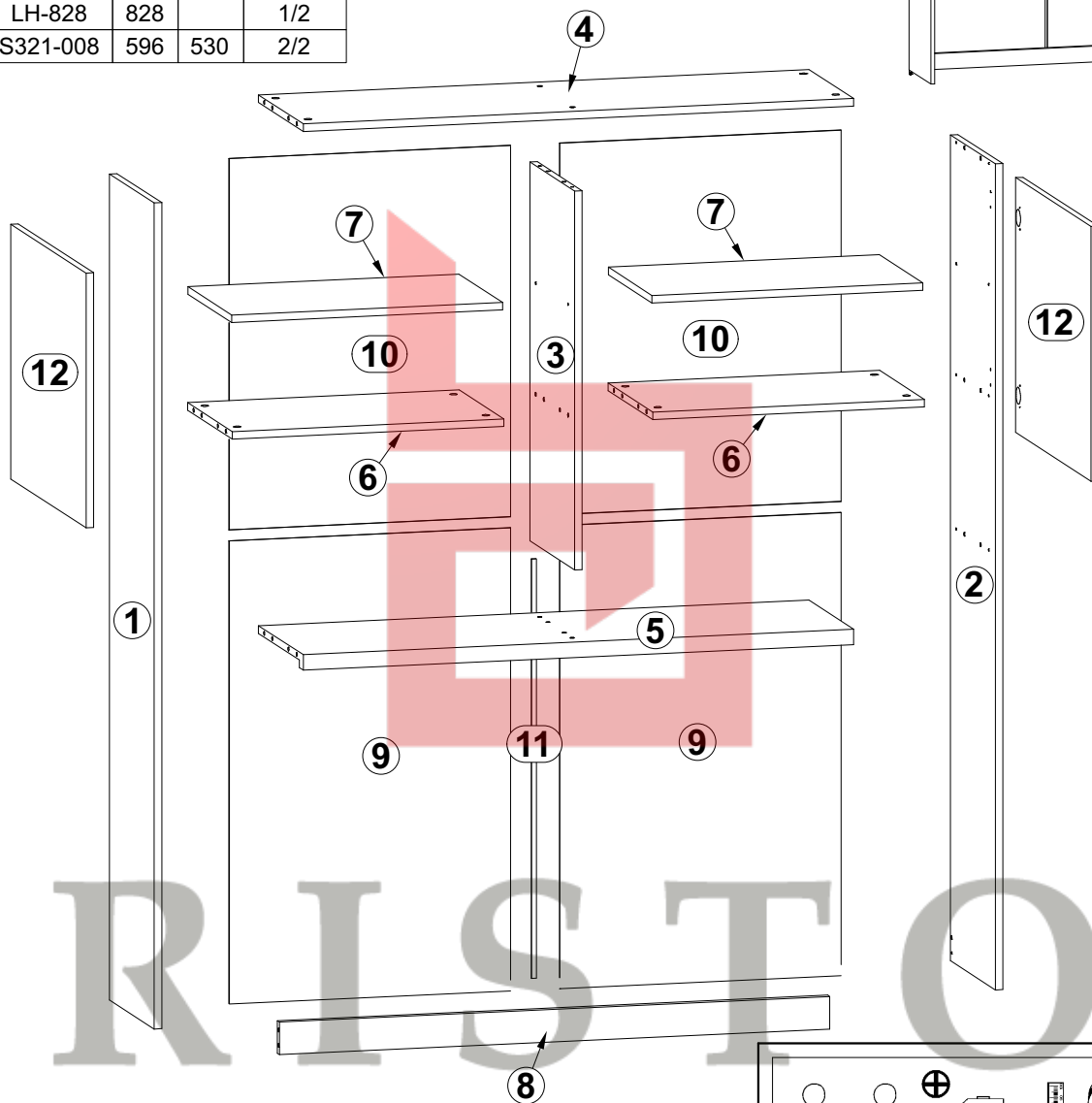
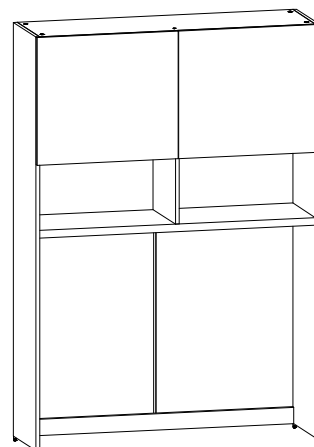

4x a44	4x b19	8x φ5x17 mm d1	4x φ7x50 mm e1	18x φ8x30 mm f1	2x φ8x50 mm f6	65x l1	1x n26/v1	
2x 62x12/1mm n52	4x silikon o21	9x φ3,5x16 mm p38	8x φ3,5x15 mm p51	6x φ3,5x20 mm p79	18x φ15x12mm #16 r1	2x r10	14x 20/11 r42	
2x s1	12x φ16 s2	1x z1						

1 

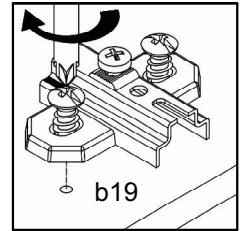
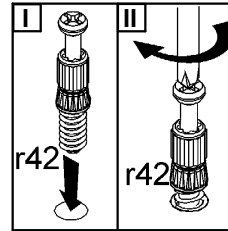
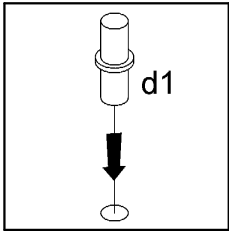
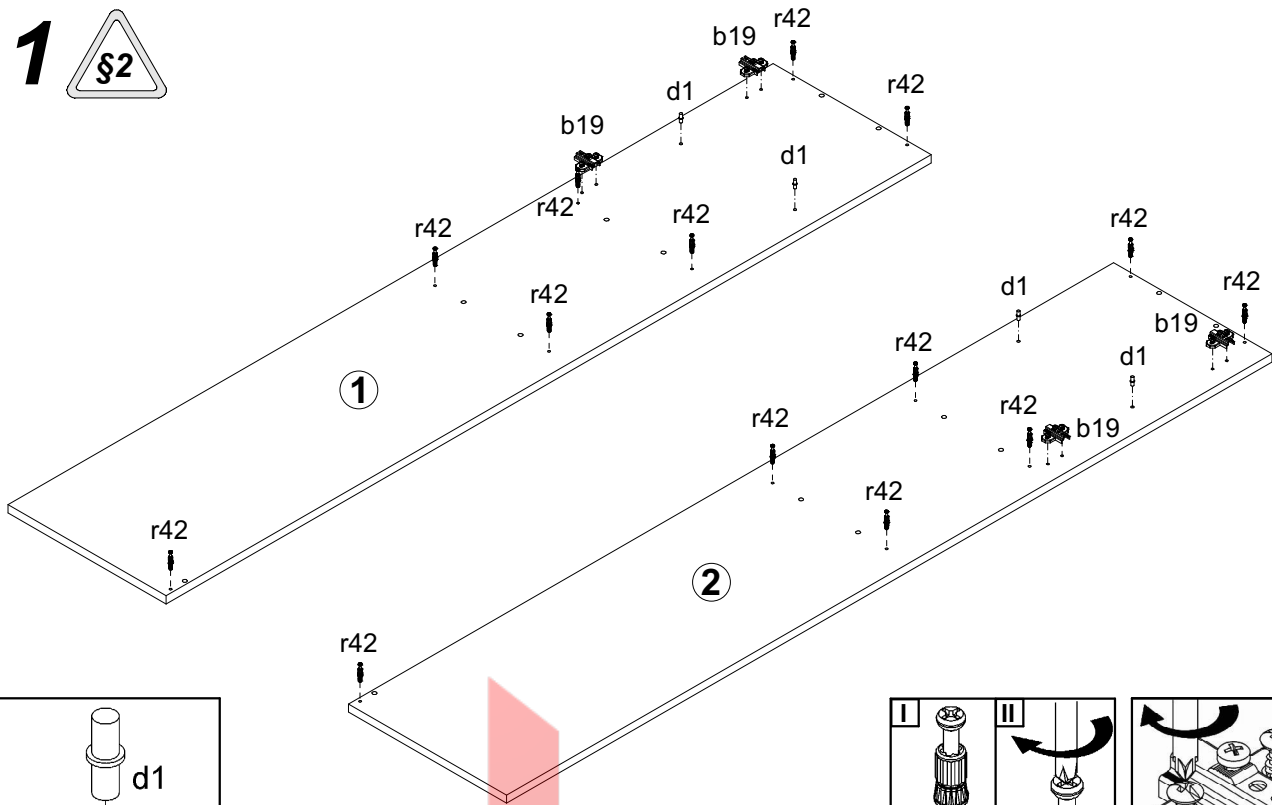

2 

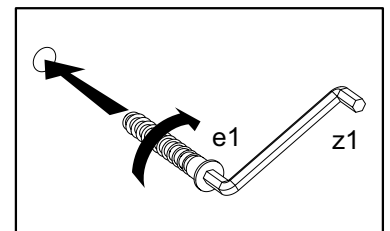
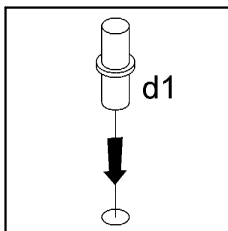
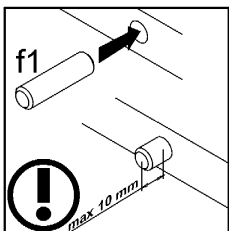
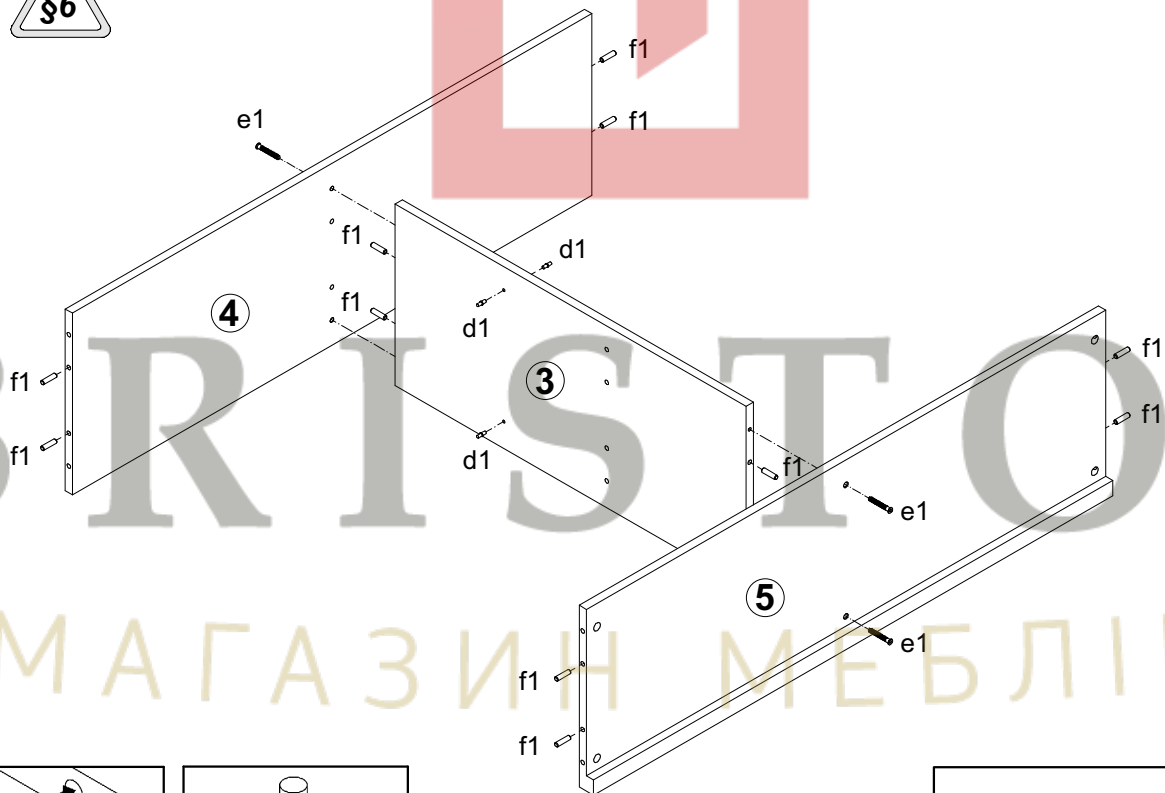

3

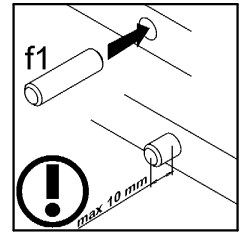
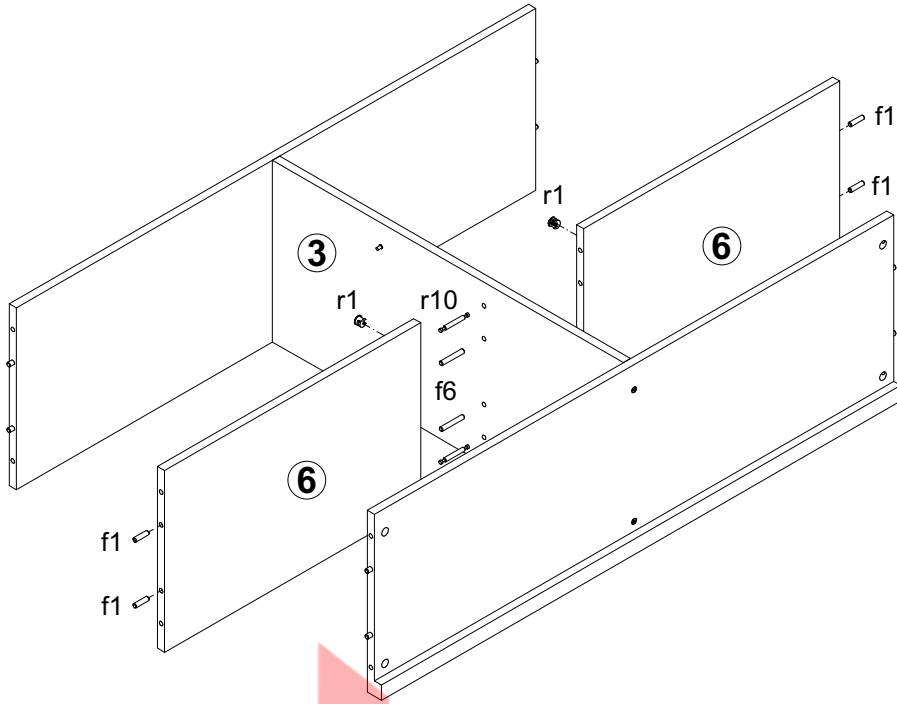

4

