

**A**

# PORTO

**S322-KOM3D3S**

A	B	C	D	A	B	C	D		
1	S322-0009	396	160	3/3	13	S322-3306	1200	381	2/3
2	S322-0010	396	160	3/3	14	S322-3307	786	356	2/3
3	S322-0011	396	160	3/3	15	S322-3308	396	356	2/3
4	S322-0012	640	396	3/3	16	S322-4408	1200	60	2/3
5	S322-0013	640	396	3/3	17	S322-9912	349	355	2/3
6	S322-0034	640	396	3/3	18	S322-9916	869	404	2/3
7	S322-1111	912	384	1/3	19	S322-9915	370	355	2/3
8	S322-1112	912	384	1/3	20	S322-9916	869	418	2/3
9	S322-1113	666	363	1/3	21	ZB-5504	317	120	1/3
10	S322-1114	168	352	1/3	22	ZB-5505	340	120	1/3
11	S322-1115	168	352	1/3	23	BB-501	350	120	1/3
12	S322-2205	1284	395	2/3	24	BB-502	350	120	1/3
					25	Lh-830	830	14	2/3

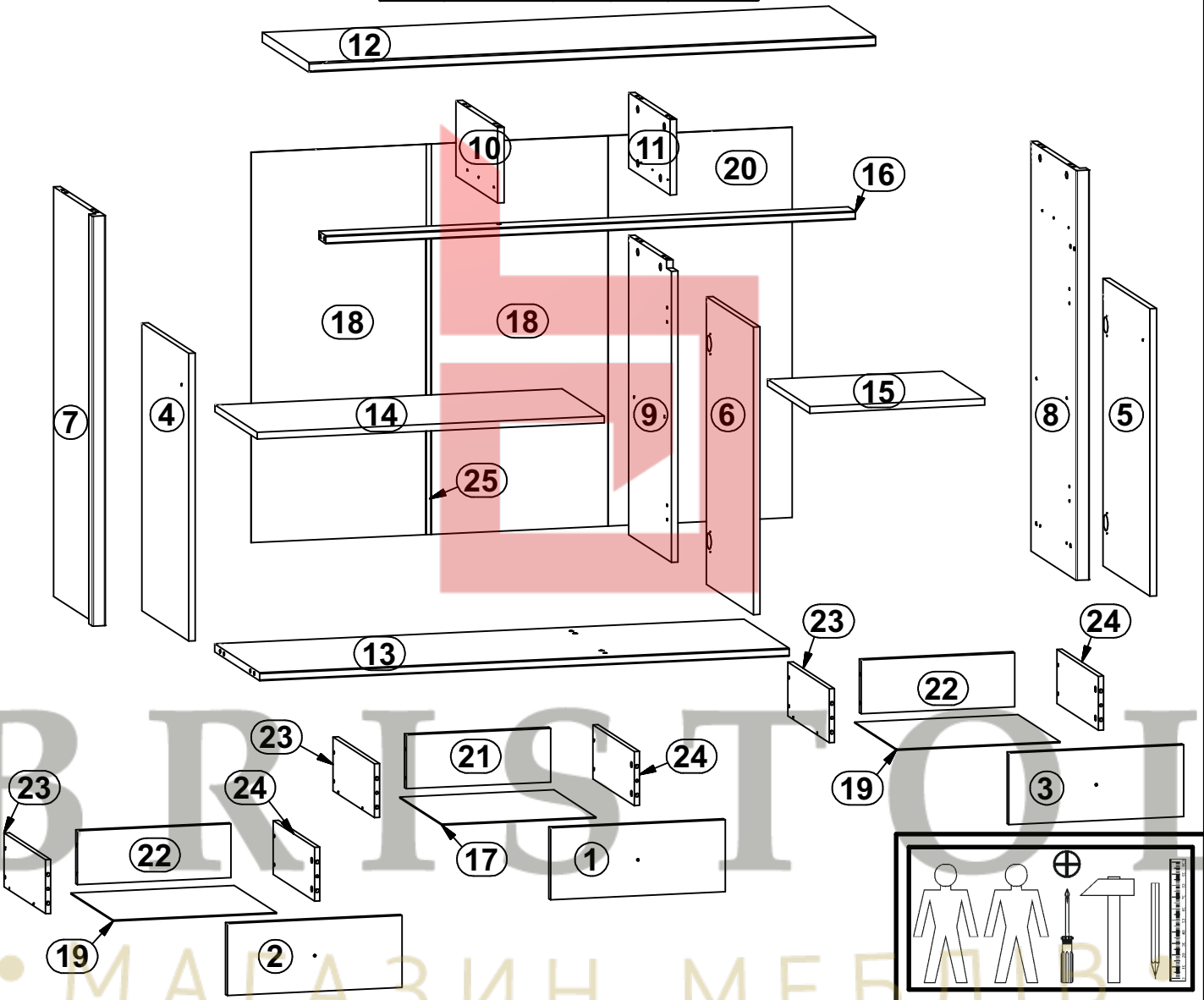
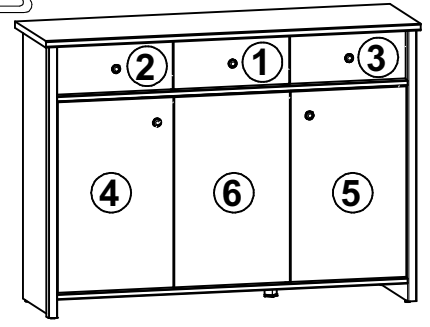

4x K16 a43	2x K0 a44	6x DS b19	5x M4 c415	8x ø5x17 mm d1	2x ø6,3x15 mm d4	3x ø7x50 mm e1	1x ø6,3x13 mm e2	12x ø6x13 mm e3
12x ø5x9 mm e19	26x L8x30 mm f1	12x ø6,5x40 mm f25	5x M4x20 mm j1	4x k1	1x 42,5x42,5x4 mm k38\3	1x 30x30x60 mm k38\8	65x l1	13x ø3,5x16 mm p38
12x ø3,5x15 mm p51	6x ø3x12 mm p54	28x ø15x12 mm #16 r1	24x 20/11 r42	2x 40 mm r51	3x 350 mm w45\CL	3x 350 mm w45\CR	3x 350 mm w45\DL	3x 350 mm w45\DR
1x ø3,5x16 mm p38	1x z1	1x n26\1	2x L116 s2					

1

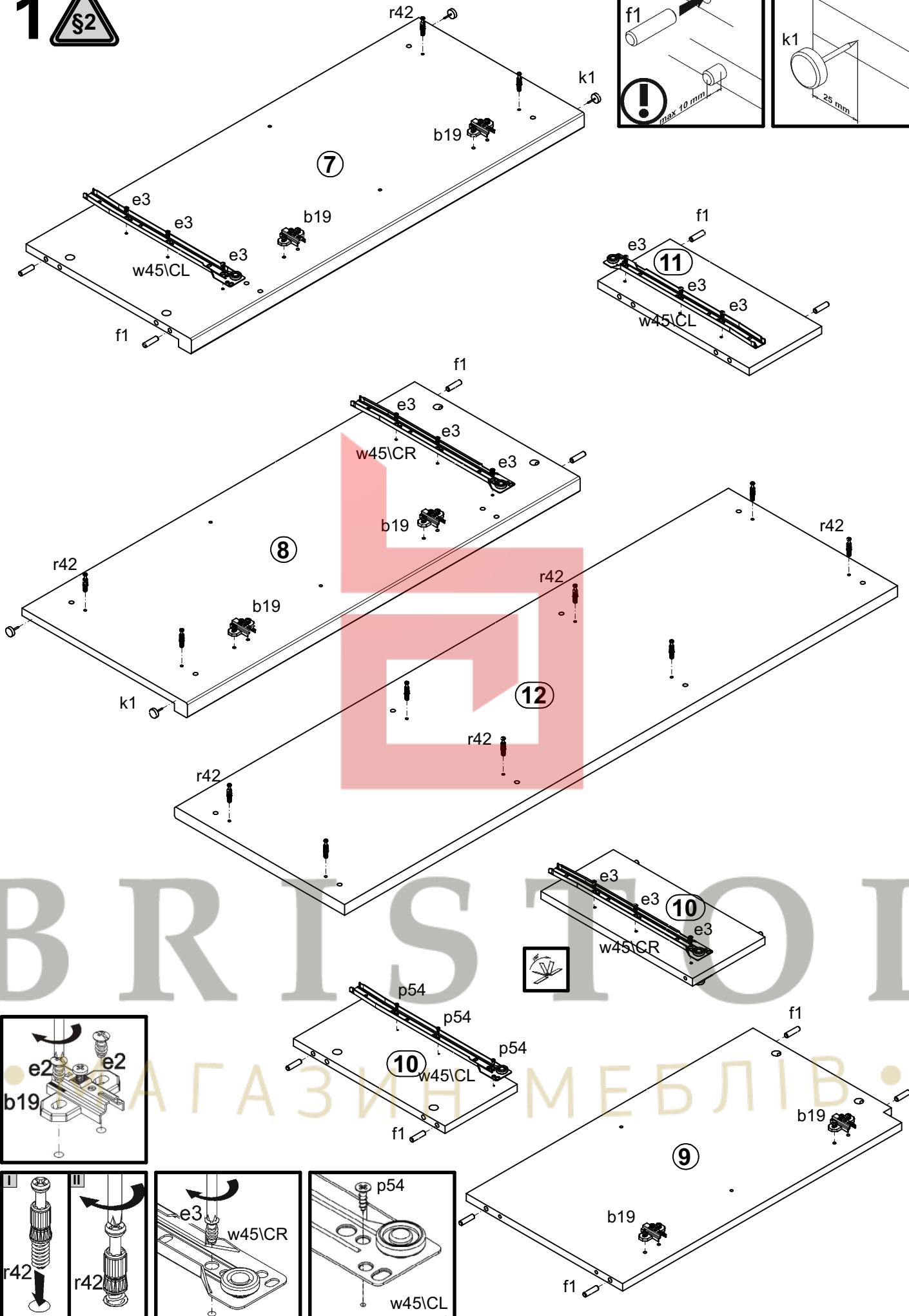
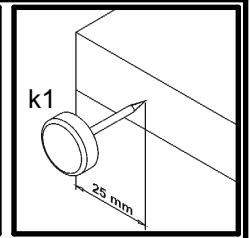
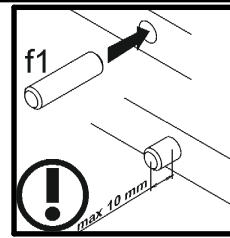

2 

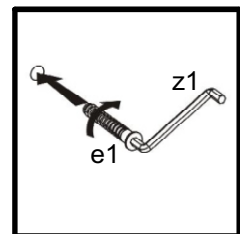
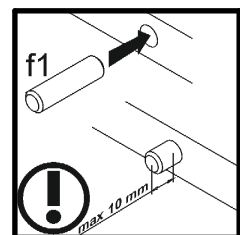
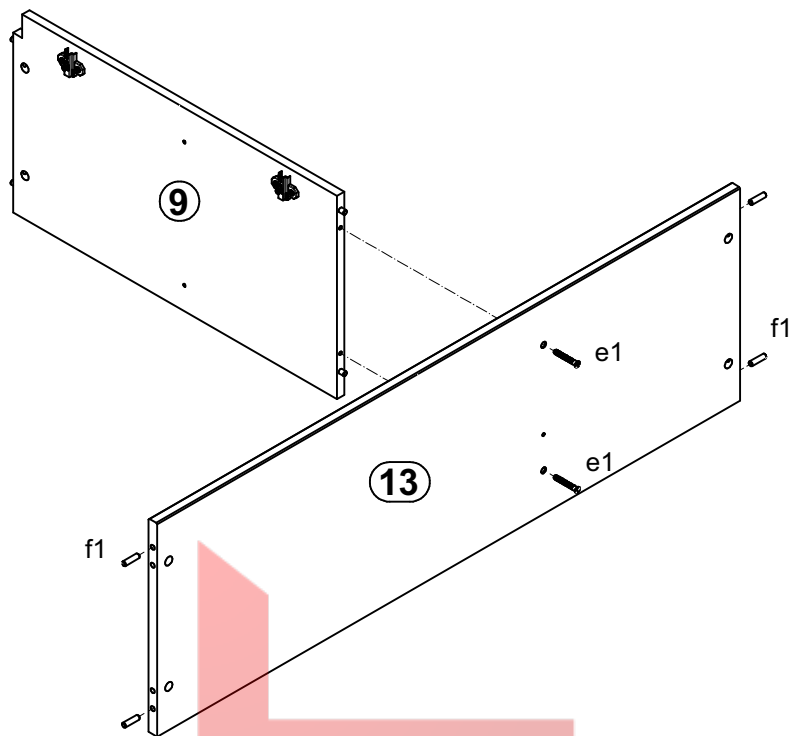

3

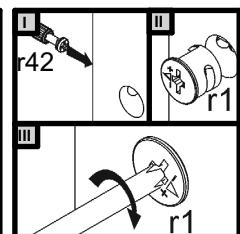
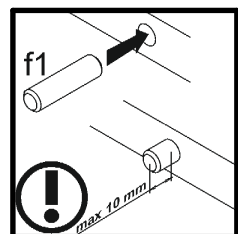
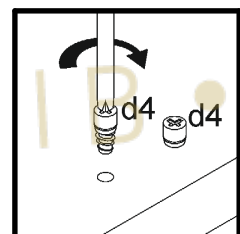
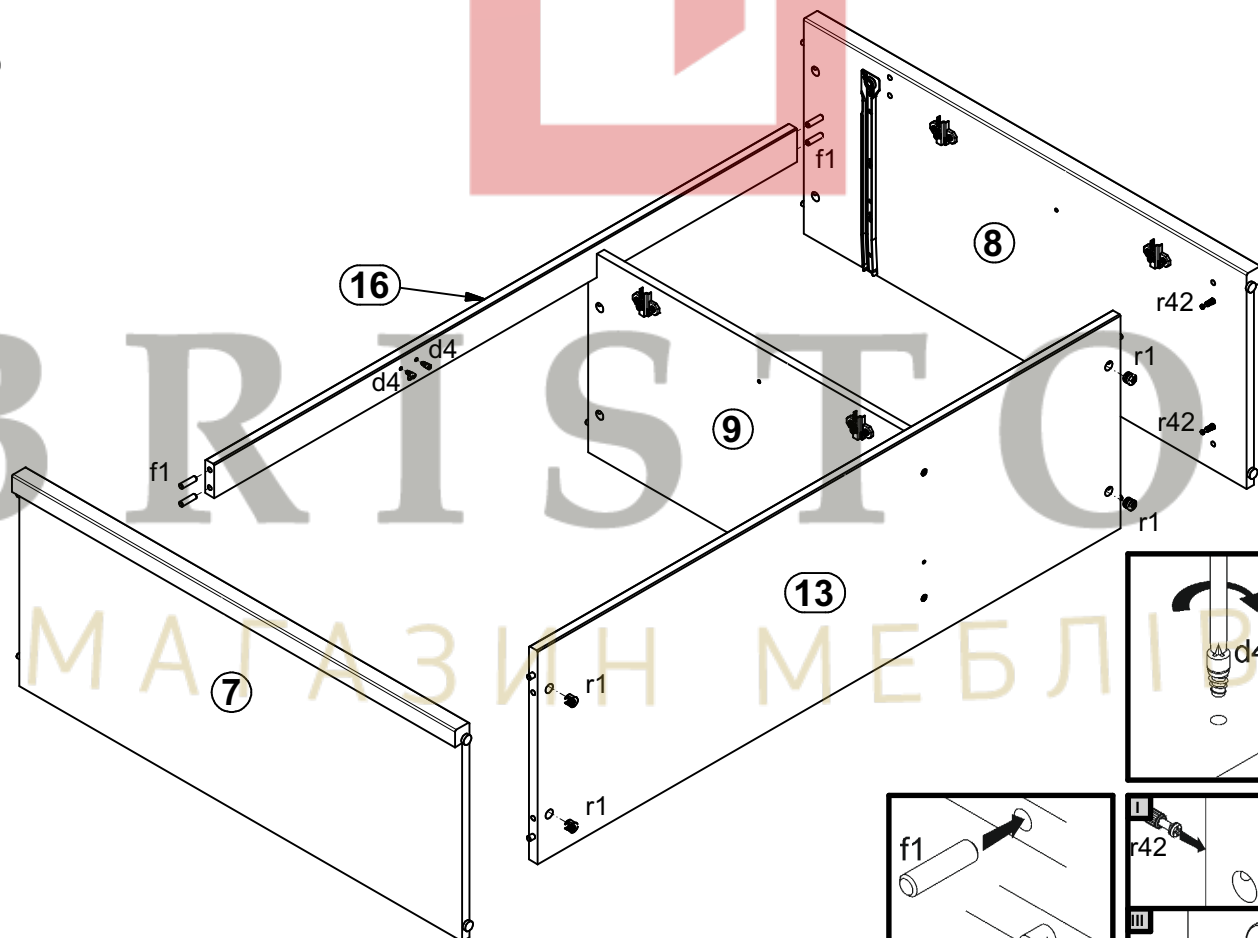

# 4

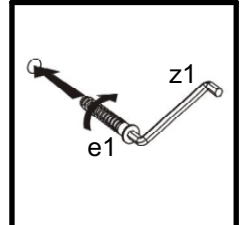
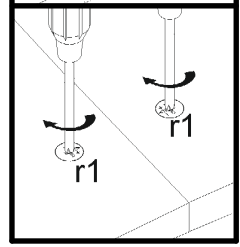
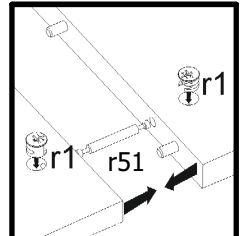
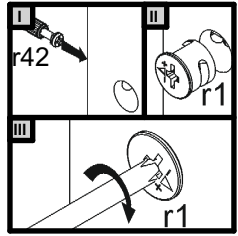
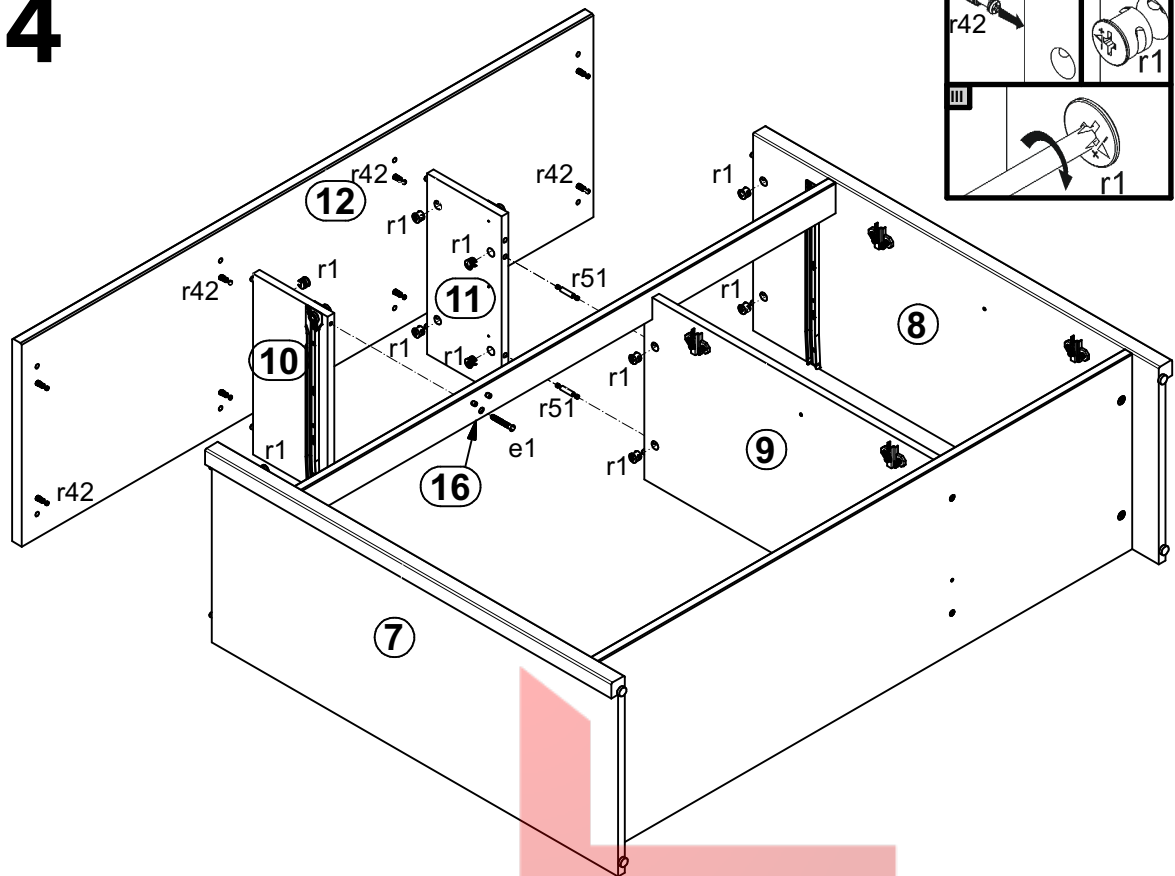

# 5

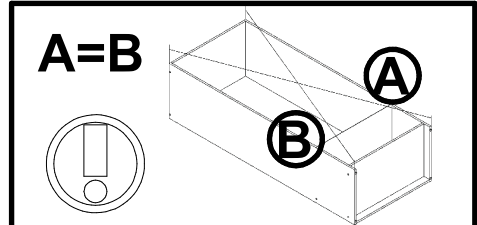
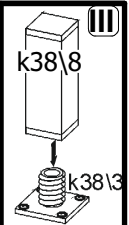
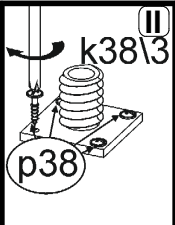
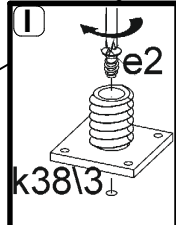
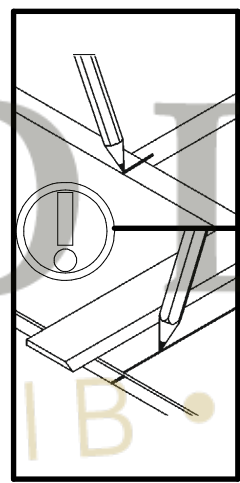
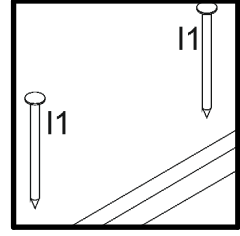
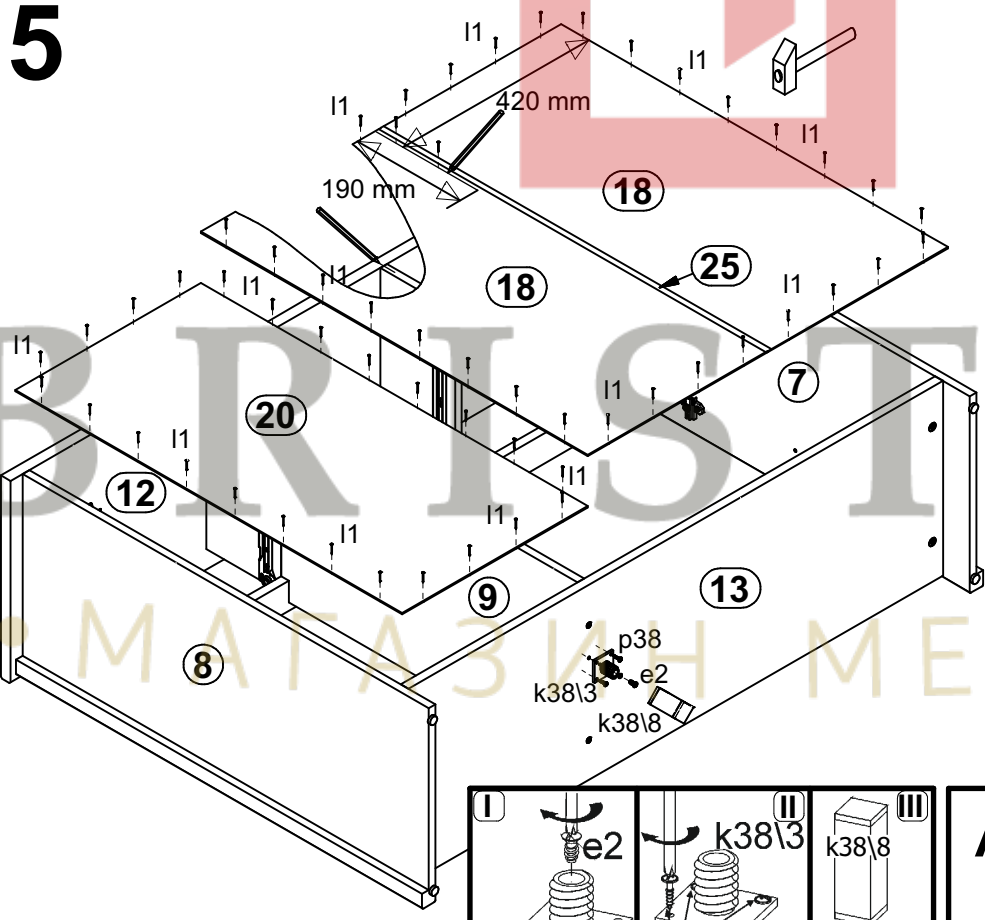

# 6

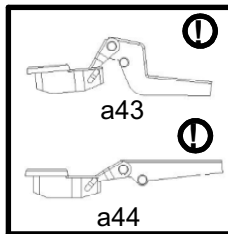
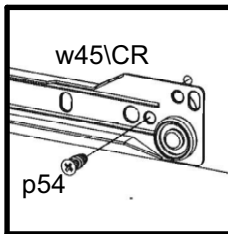
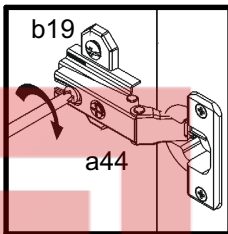
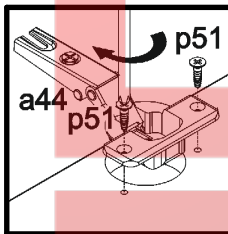
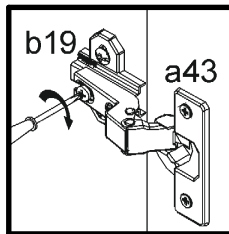
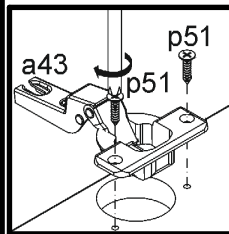
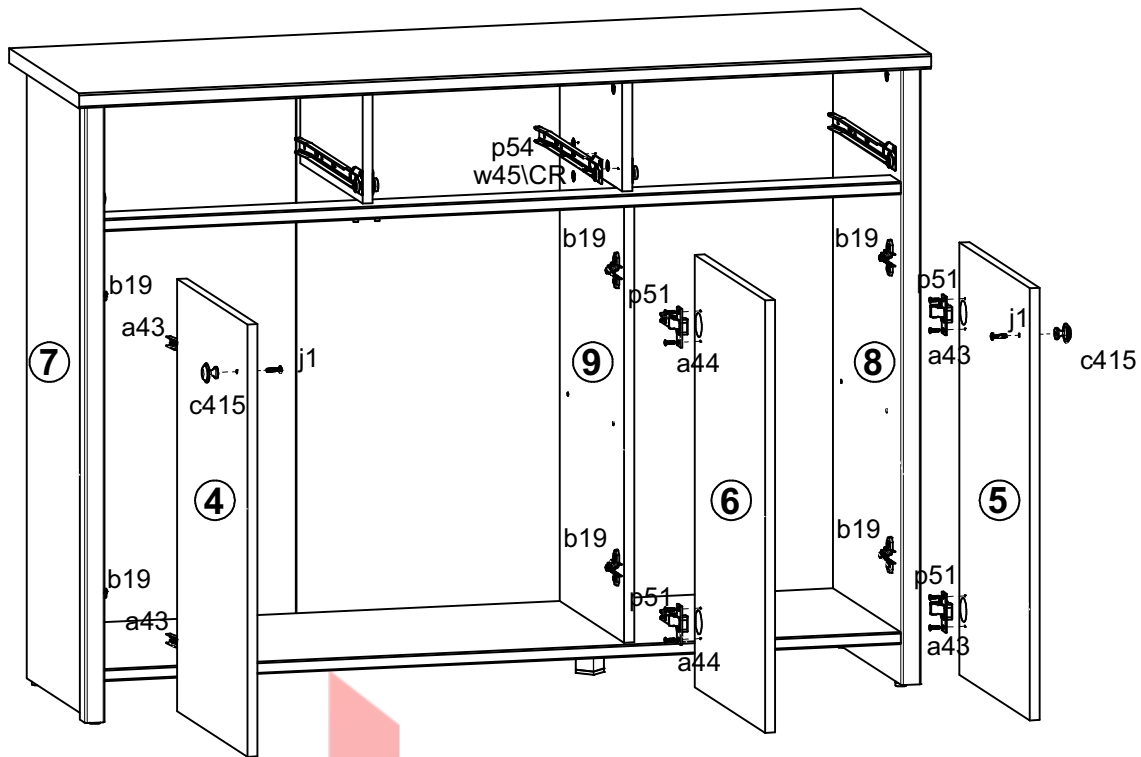

# 7

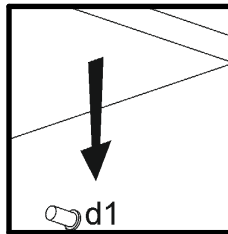
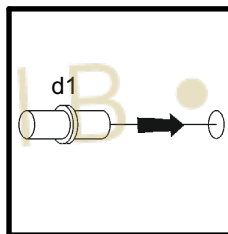
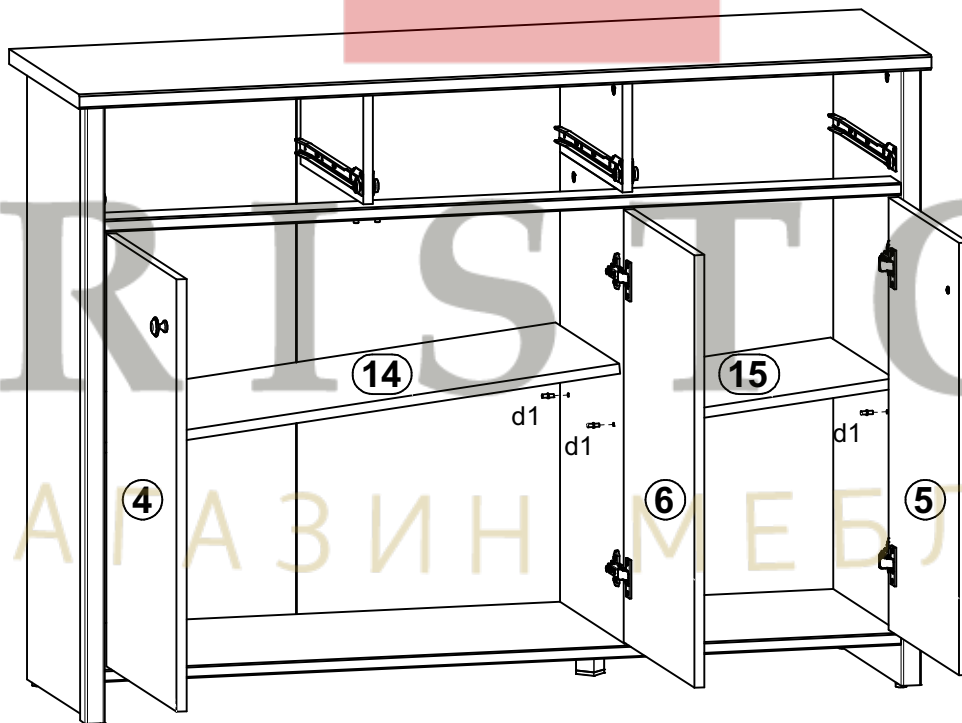

# 8

## II

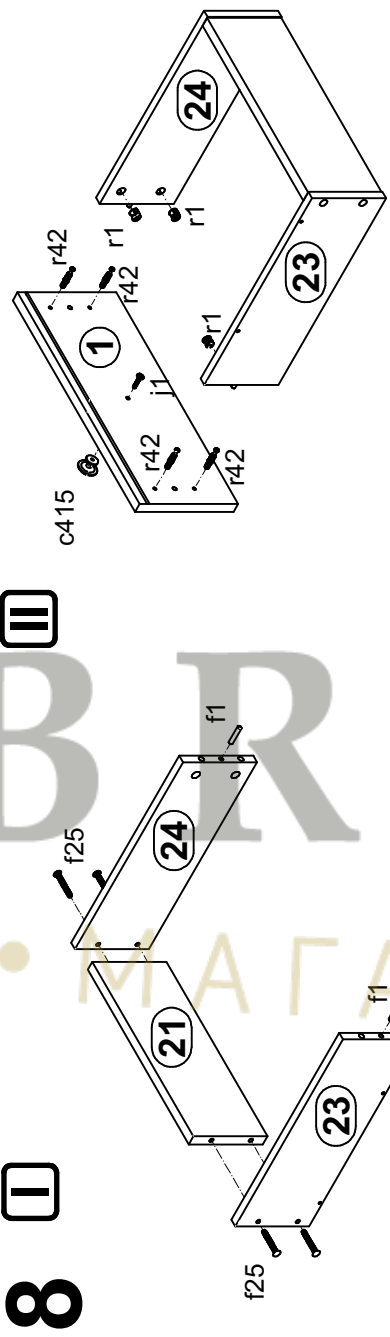

## III

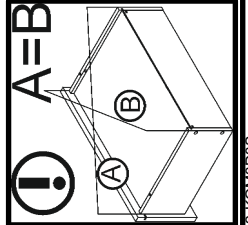
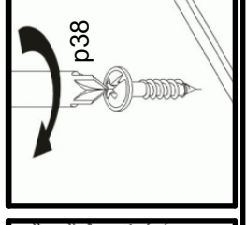
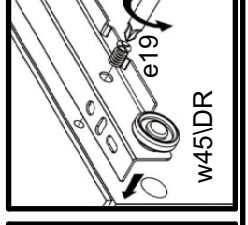
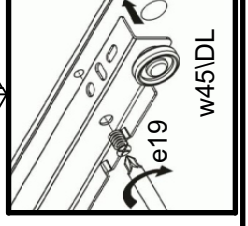
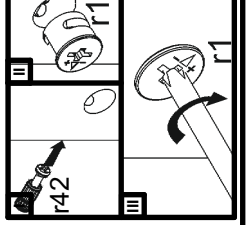
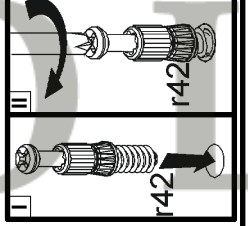
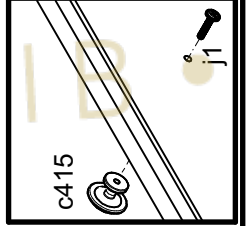
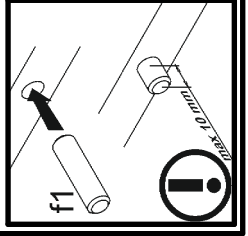
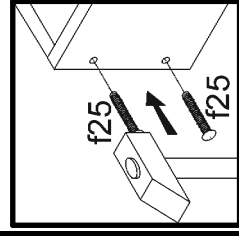
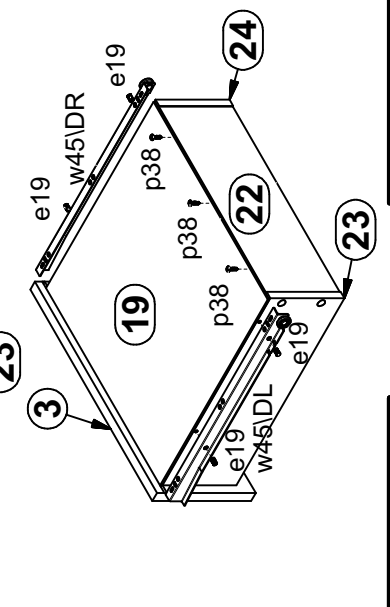
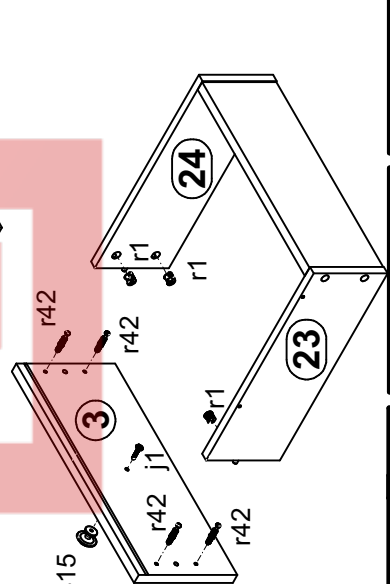
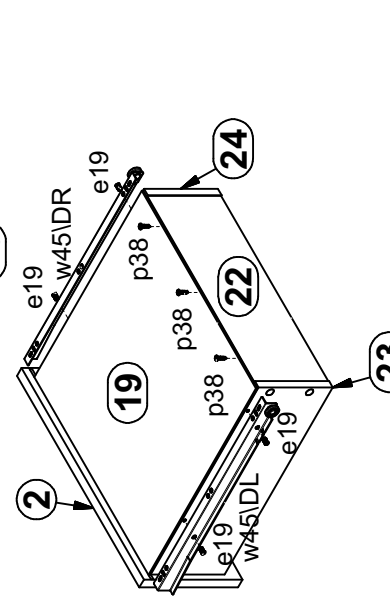
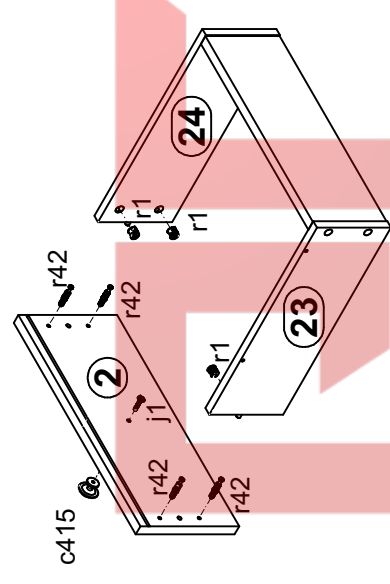
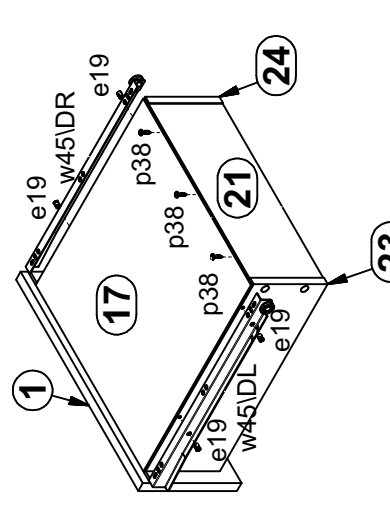

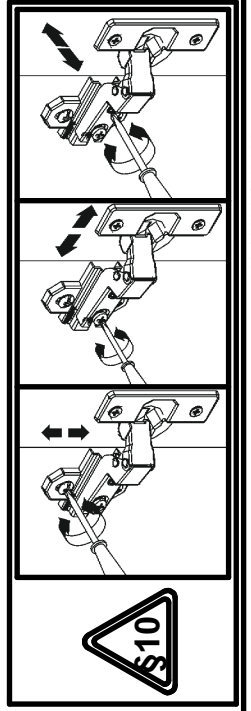
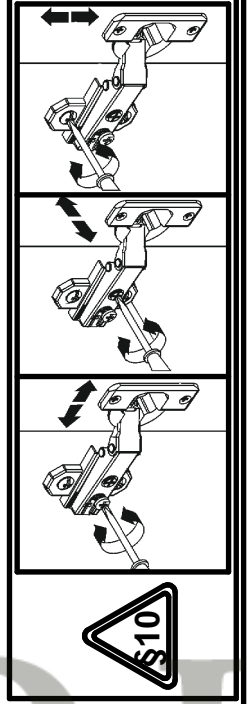
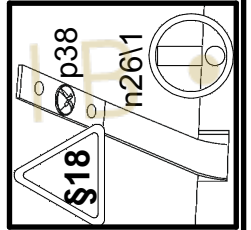
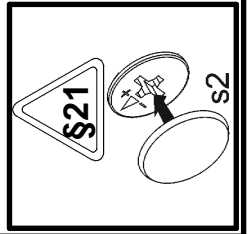
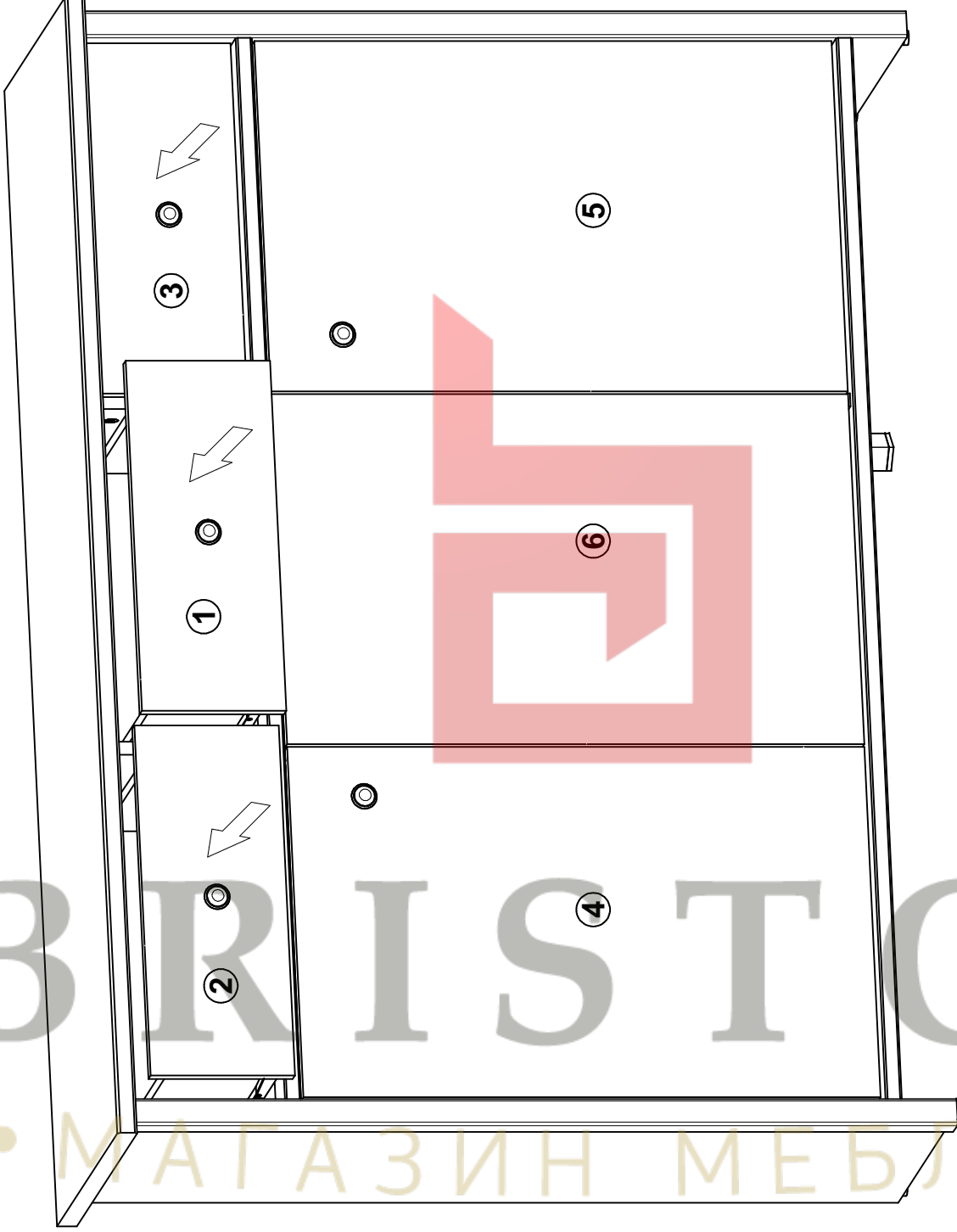

BRISTOL  
 МАГАЗИН МЕБЕЛЬ