

A	B	C	D
1	NI1-011	1948	396
2	NI1-012	396	196
3	NI1-013	396	196
4	NI1-014	396	196
5	NI1-119	1950	380
6	NI1-120	1950	380
7	NI1-121	981	380
8	NI1-124	566	380
9	NI1-125	338	380
10	NI1-316	768	380
11	NI1-317	768	380
12	NI1-319	768	380
13	NI1-320	359	375
14	NI1-321	393	375
15	NI1-322	392	380
16	NI1-323	375	375
17	NI1-1913	1945	413
18	NI1-1914	1945	381
19	NI1-914	334	349
20	NI1-5587	319	120
21	NI1-501	350	120
22	NI1-502	350	120
23	LH-565	565	

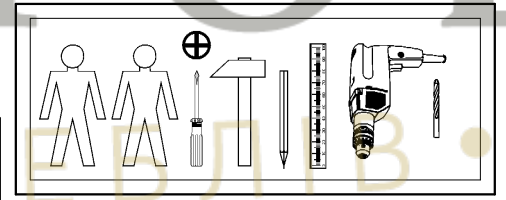

4x a44	4x b19	1x c391\1	1x 98mm c391\2	1x 196mm c391\3				
20x φ5x17 mm d1	18x φ6x13 mm e3	12x φ5x50 mm e32	26x φ8x30 mm f1	5x 84x40/25 mm k77	65x l1	1x n26\1	10x 20x13x3,5\1mm n108	
10x φ4x25 mm p36	1x φ3,5x16 mm p38	8x φ3,5x15 mm p51	12x φ3x12 mm p54	10x φ2,9x16 mm p55	5x φ4x25 mm p87	38x φ15x12mm #16 r1	38x 20/11 r42	
24x φ16 s2	3x 350 mm w45\CL	3x 350 mm w45\CR	3x 350 mm w45\DL	3x 350 mm w45\DR				

1

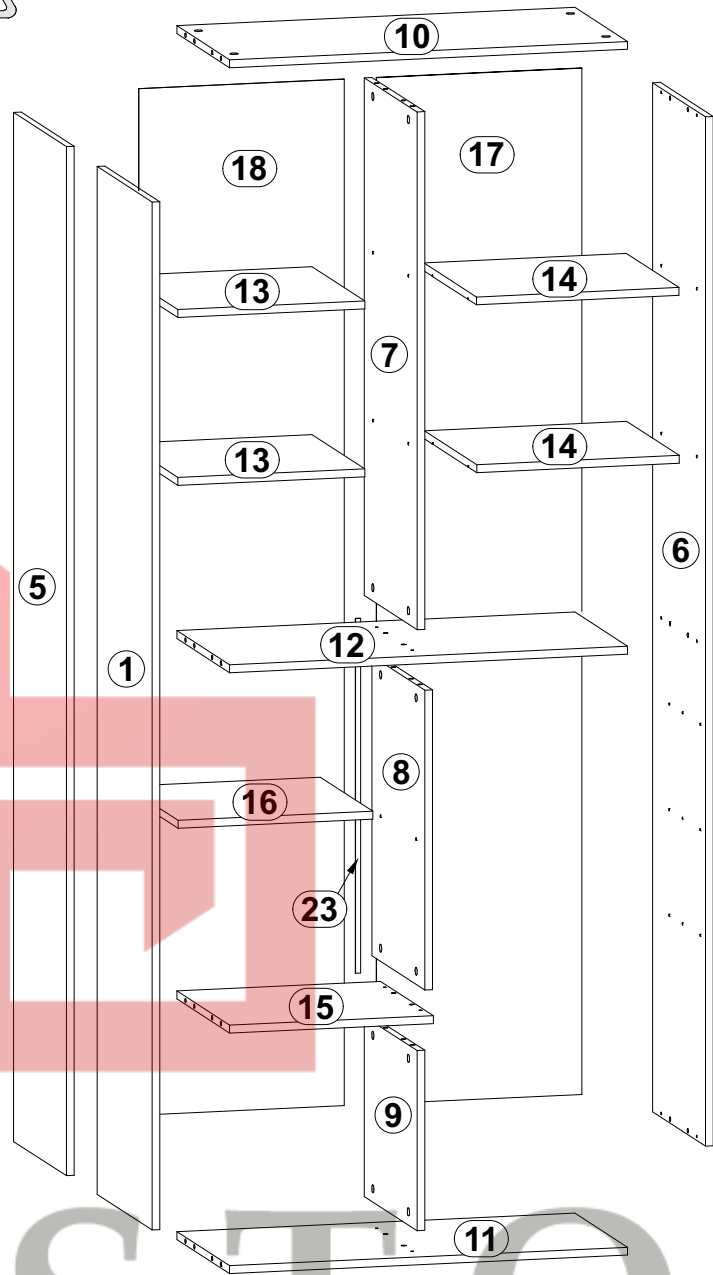
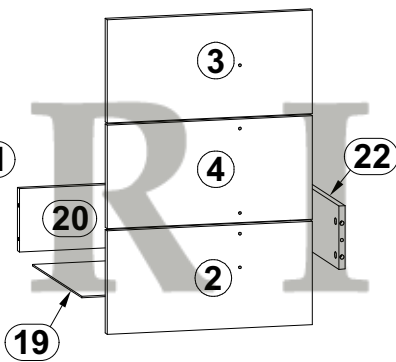
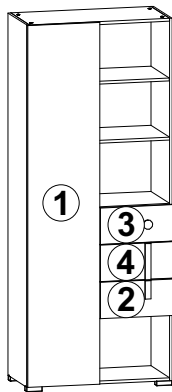
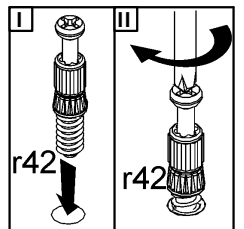
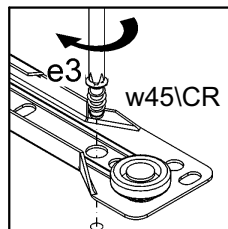
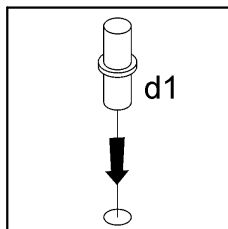
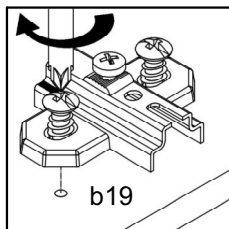
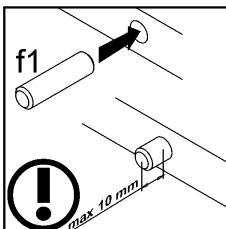
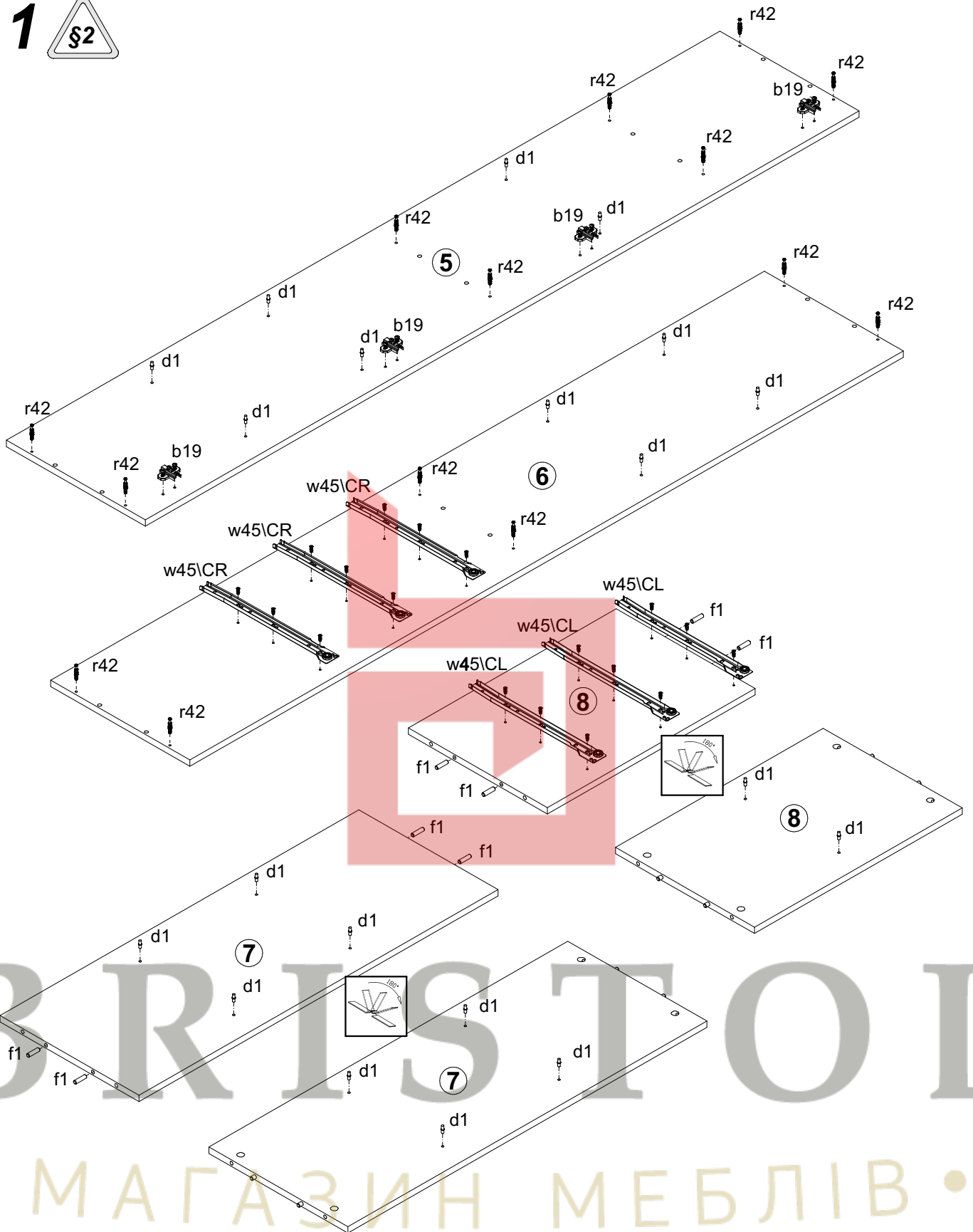

2 

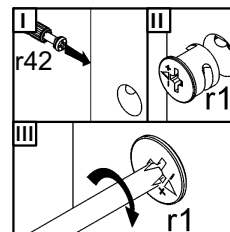
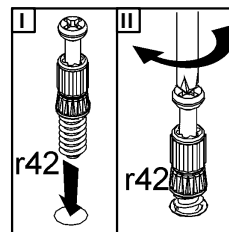
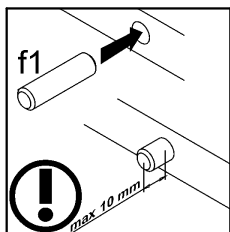
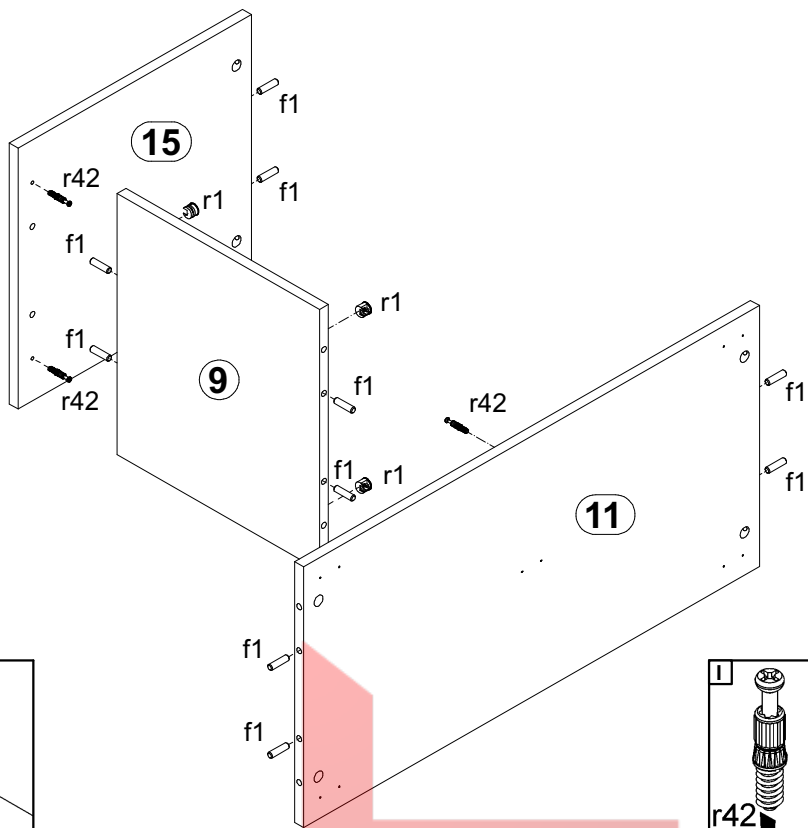

3

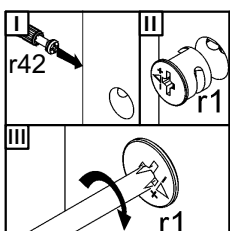
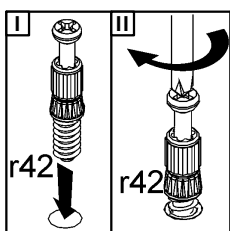
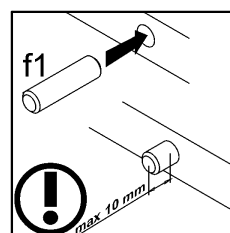
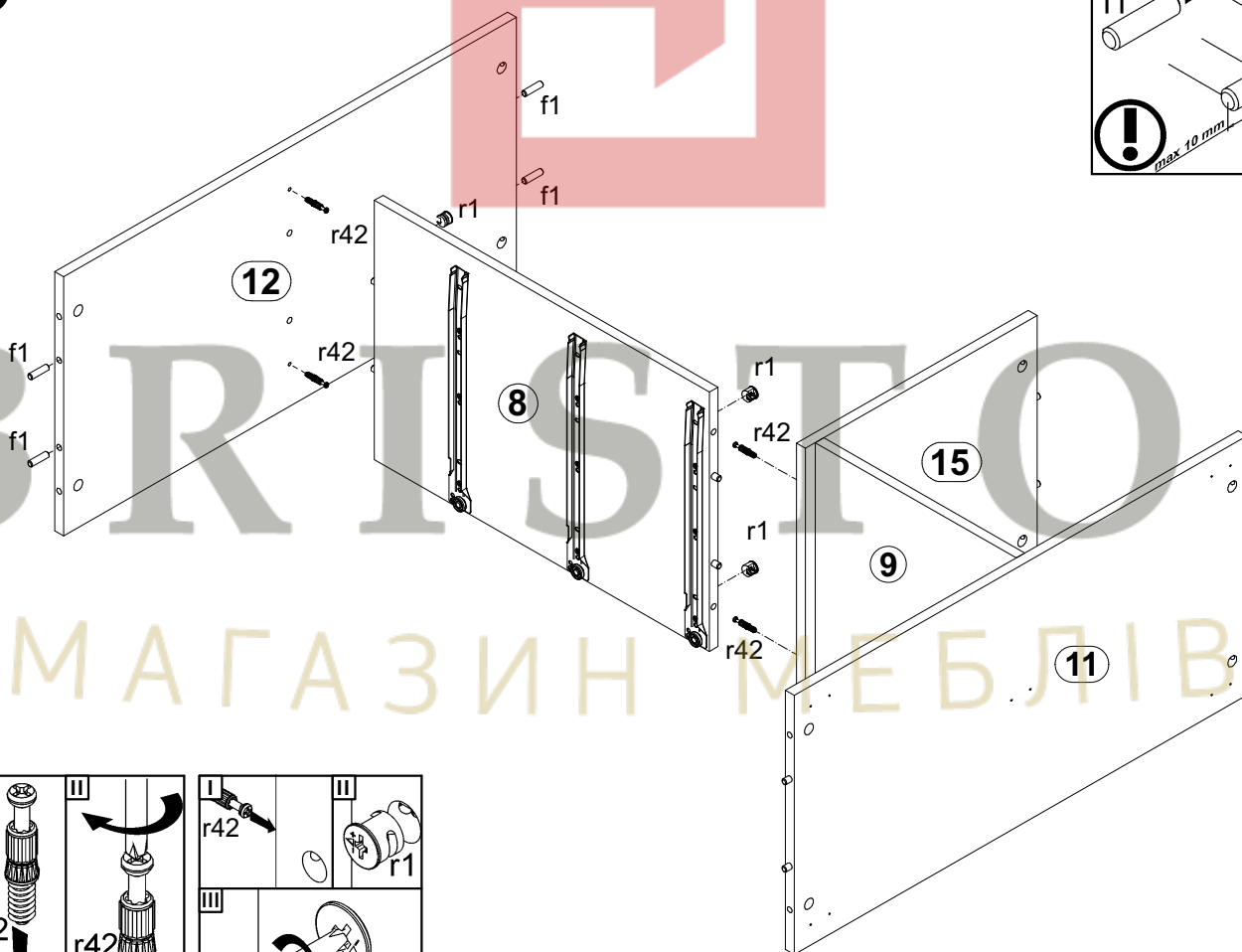

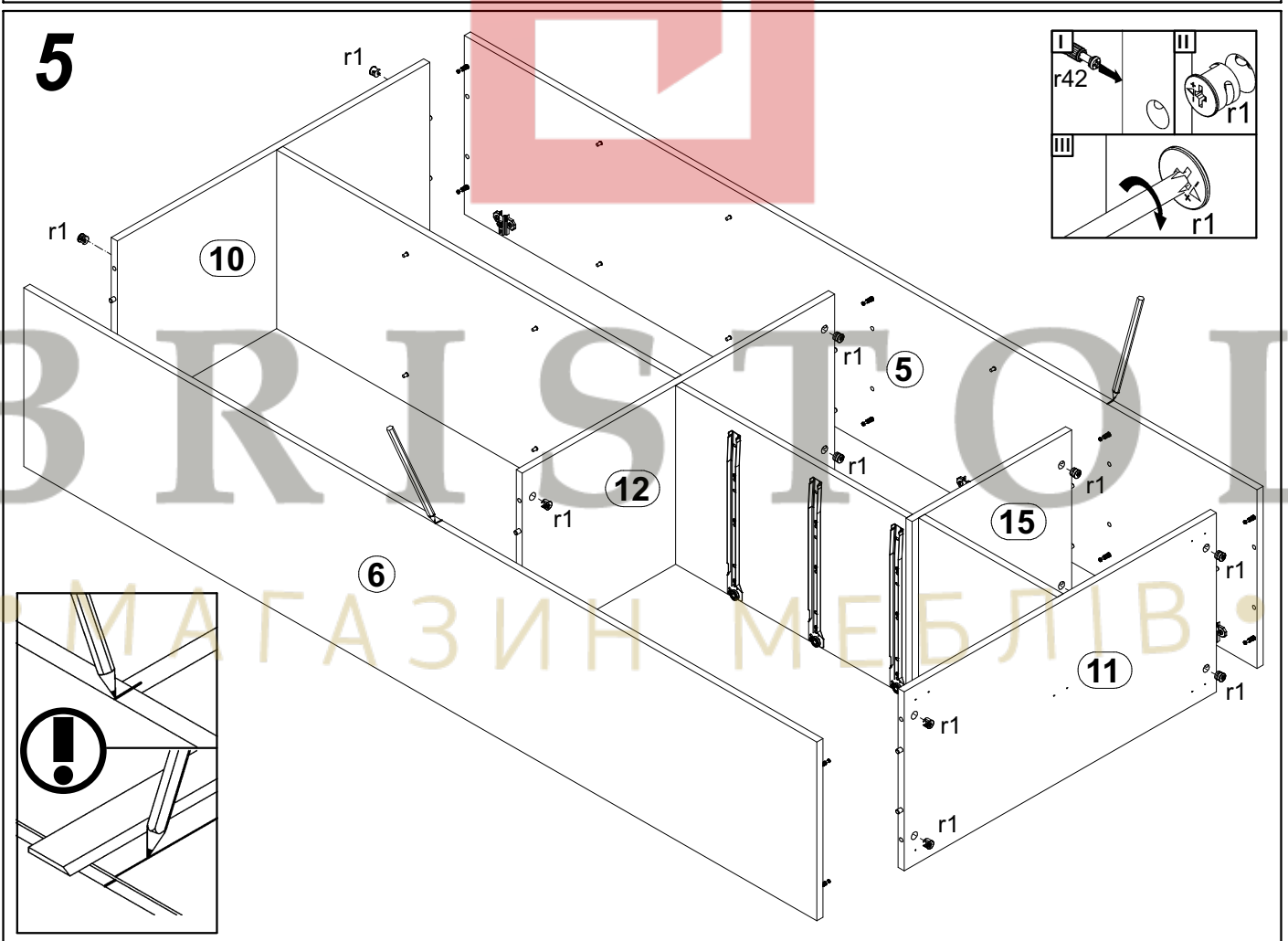
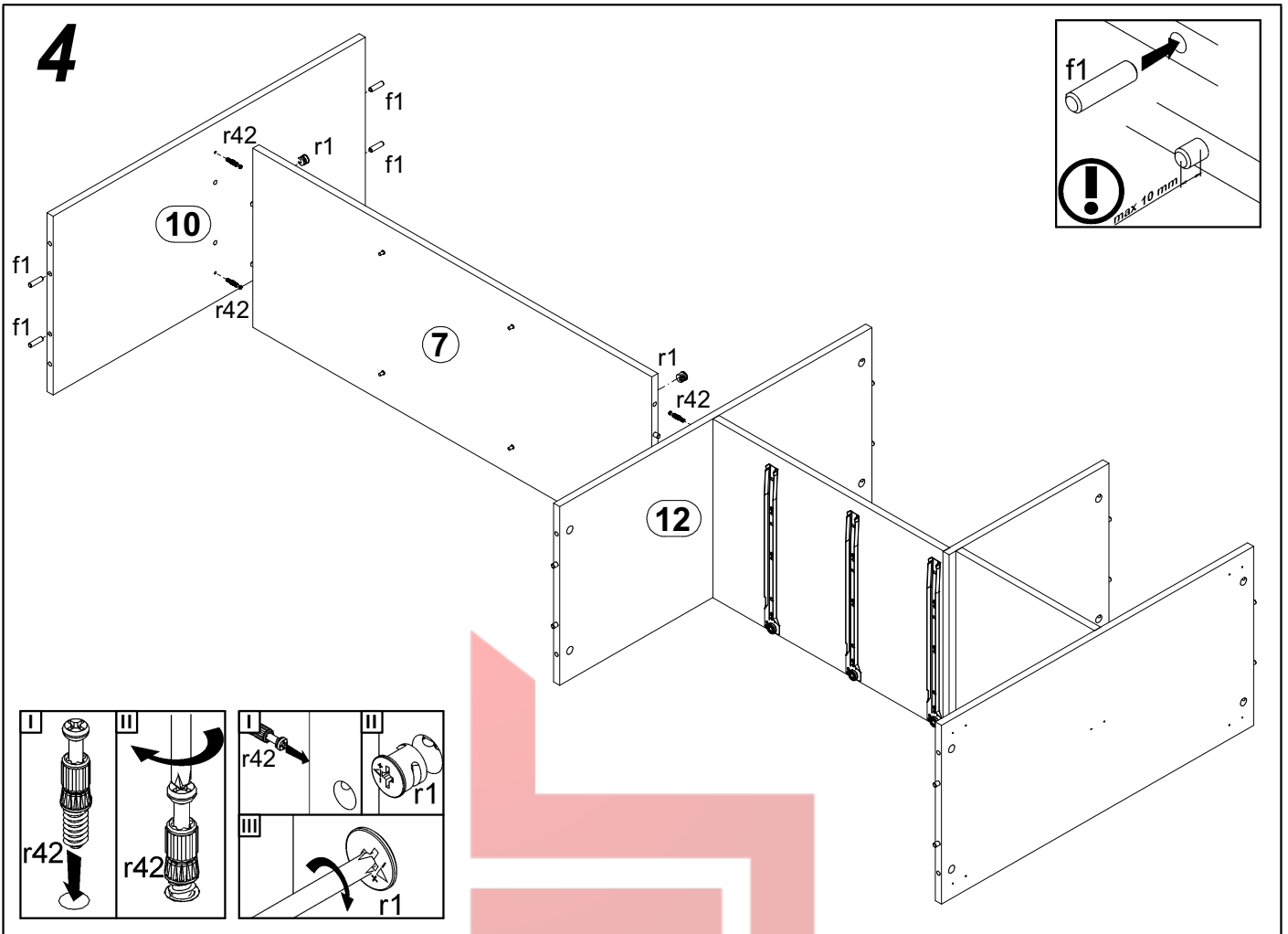

6

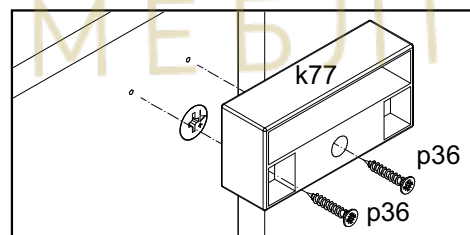
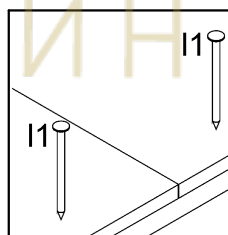
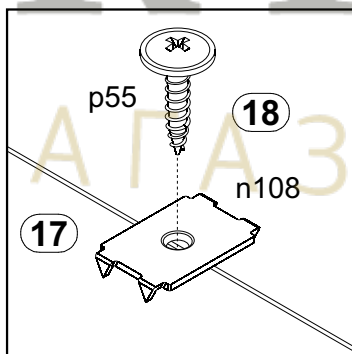
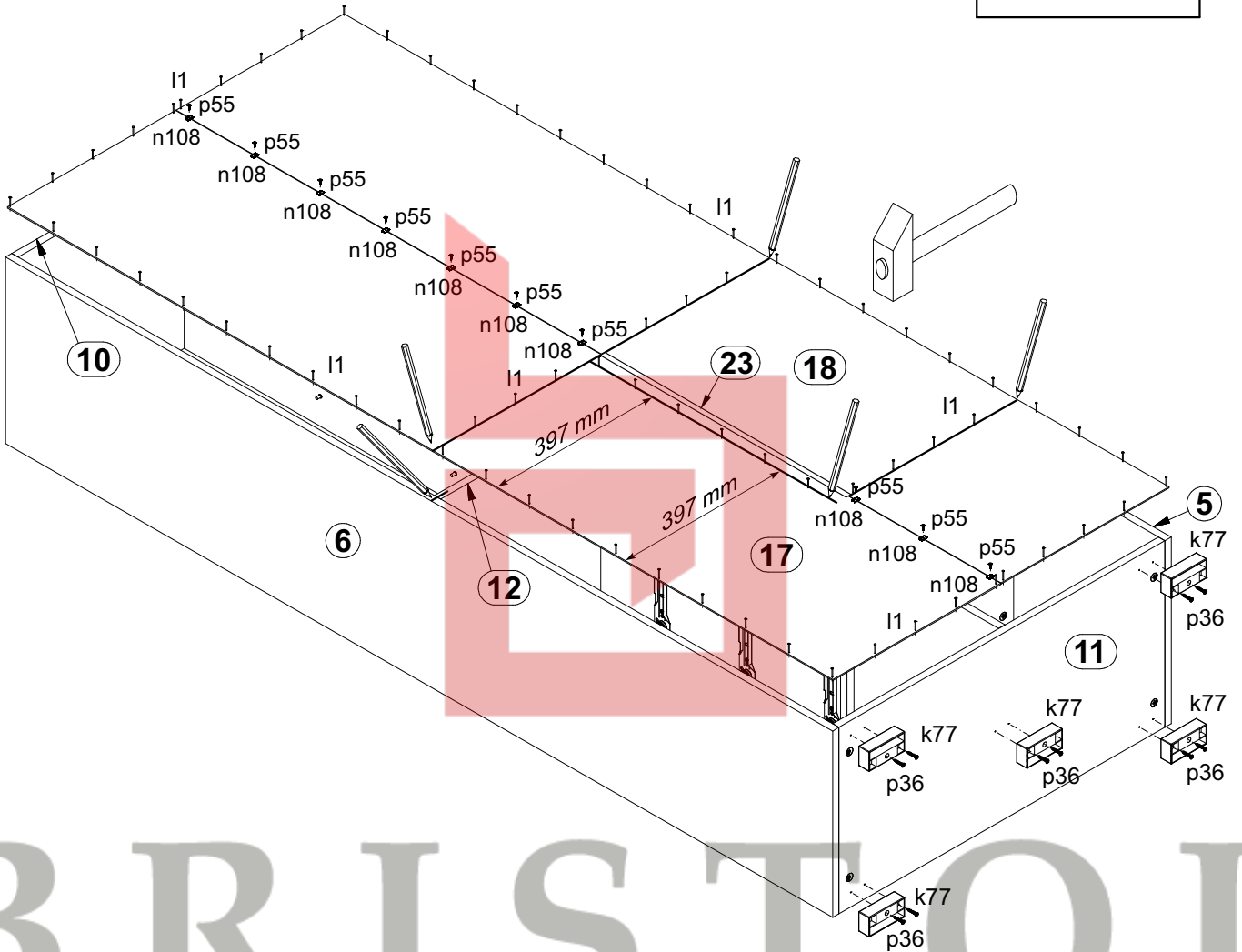
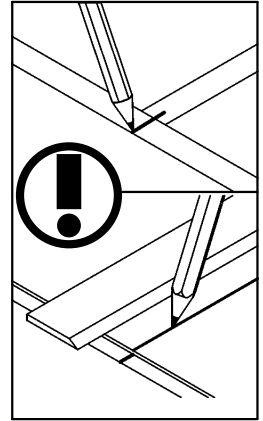
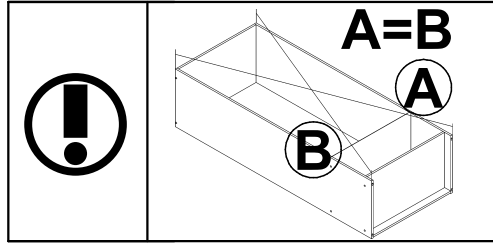

7

I

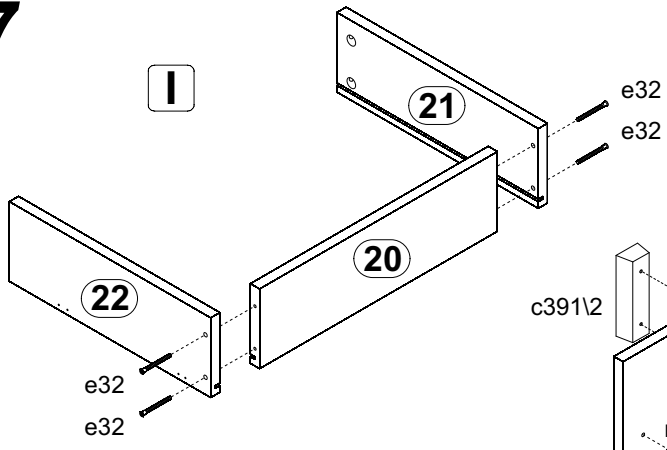

II

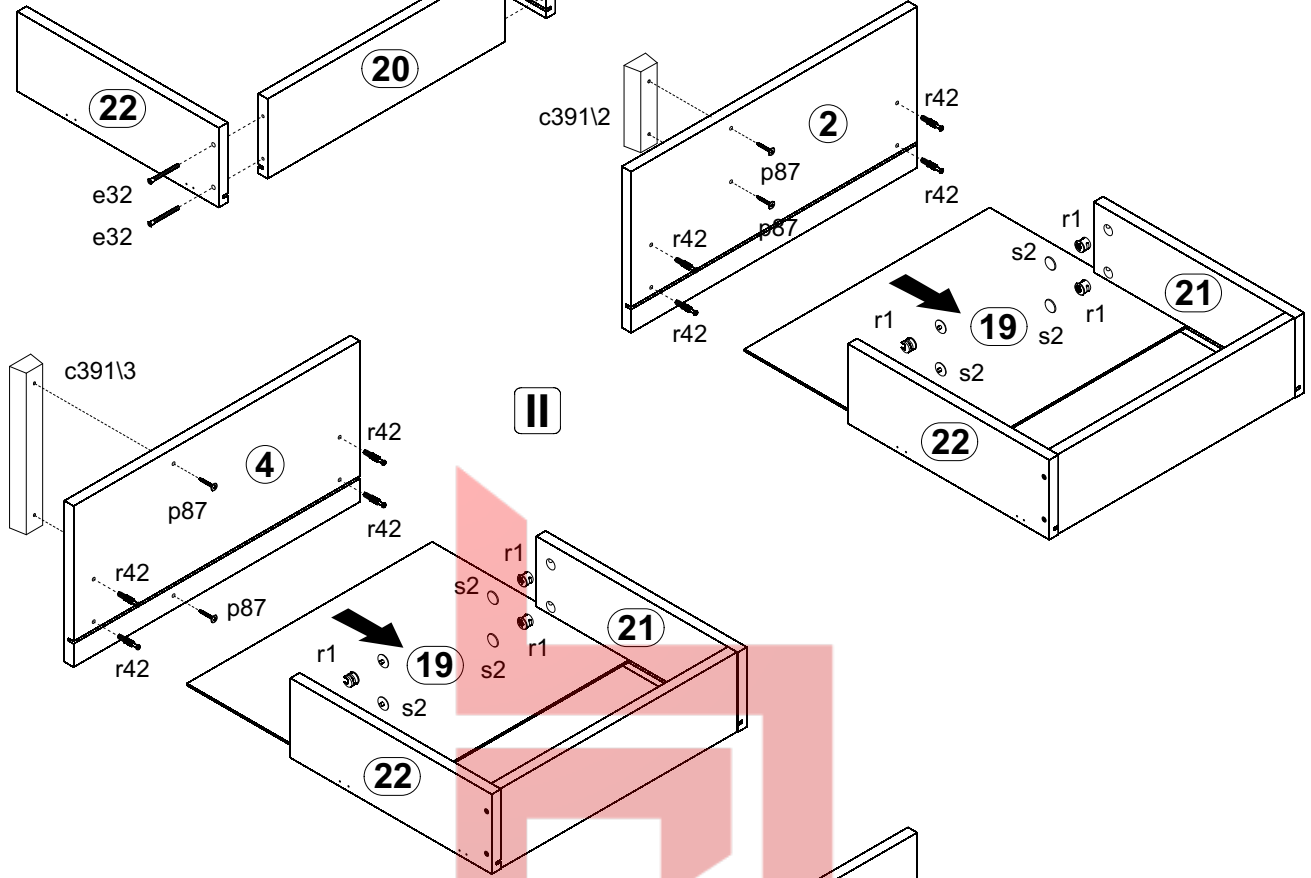

III

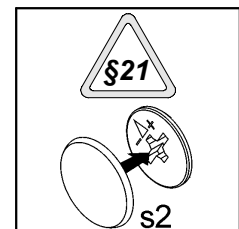
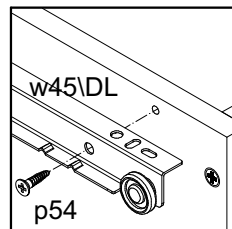
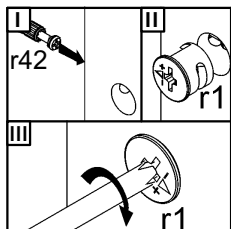
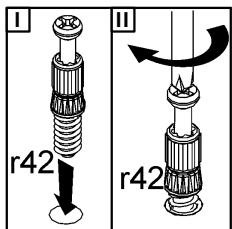
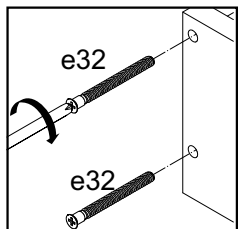
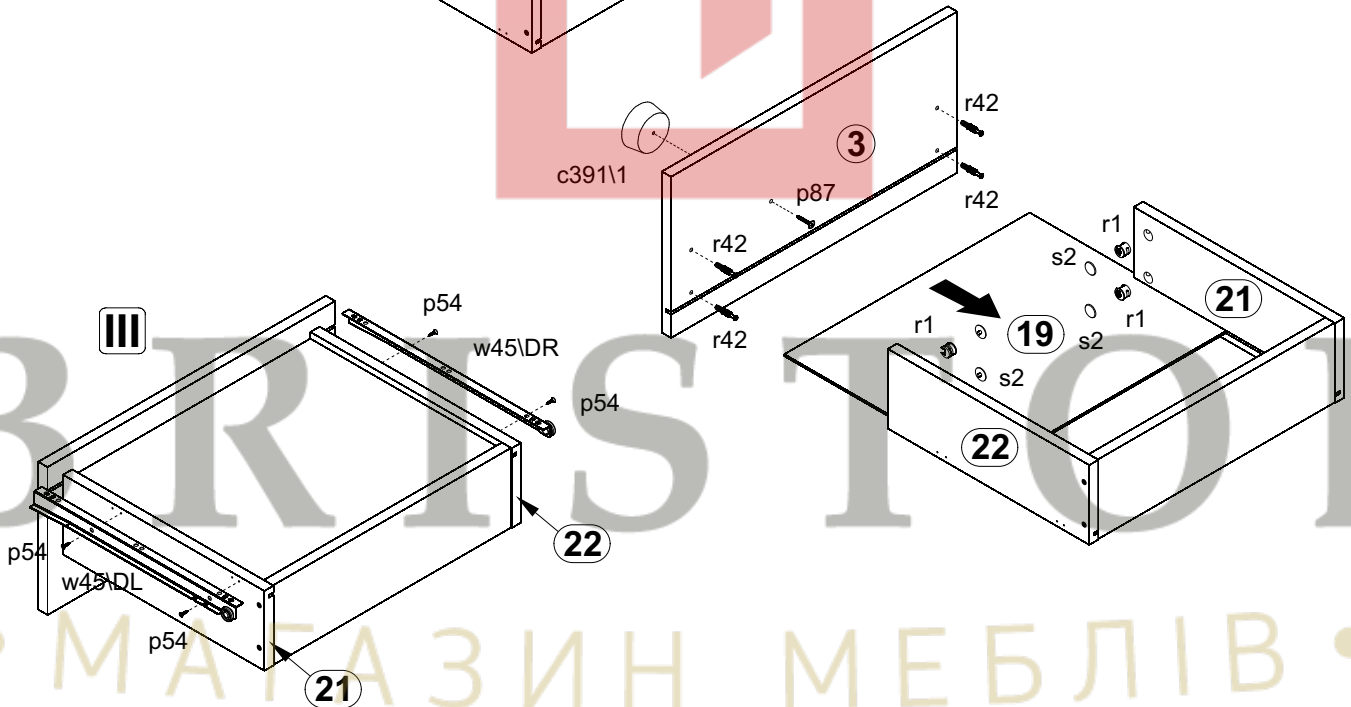

8

