

10 30 WW 20

S117-KOM3W3S/14/18-B

| A | B | C | D | A | B | C | D | | |
|----|-----------|------|-----|-----|----|----------|------|-----|-----|
| 1 | S117-006 | 596 | 175 | 4/4 | 14 | S117-404 | 585 | 120 | 3/4 |
| 2 | S117-007 | 596 | 175 | 4/4 | 15 | S117-453 | 601 | 560 | 4/4 |
| 3 | S117-008 | 596 | 175 | 4/4 | 16 | S117-454 | 588 | 560 | 4/4 |
| 4 | S117-012A | 871 | 596 | 4/4 | 17 | S117-506 | 535 | 86 | 3/4 |
| 5 | S117-013A | 871 | 596 | 4/4 | 18 | S117-509 | 545 | 86 | 3/4 |
| 6 | S117-115A | 1055 | 400 | 2/4 | 19 | S117-510 | 300 | 100 | 3/4 |
| 7 | S117-116A | 1055 | 400 | 2/4 | 20 | S117-511 | 300 | 100 | 3/4 |
| 8 | S117-117A | 1055 | 380 | 2/4 | 21 | S117-916 | 1777 | 193 | 1/4 |
| 9 | S117-212A | 1800 | 418 | 1/4 | 22 | S117-917 | 545 | 306 | 3/4 |
| 10 | S117-213A | 1800 | 418 | 1/4 | 23 | S117-918 | 555 | 306 | 3/4 |
| 11 | S117-308A | 575 | 380 | 3/4 | 24 | S117-919 | 1777 | 312 | 1/4 |
| 12 | S117-309A | 585 | 380 | 3/4 | 25 | qb29\3 | | | 2/4 |
| 13 | S117-403 | 575 | 120 | 3/4 | | | | | |

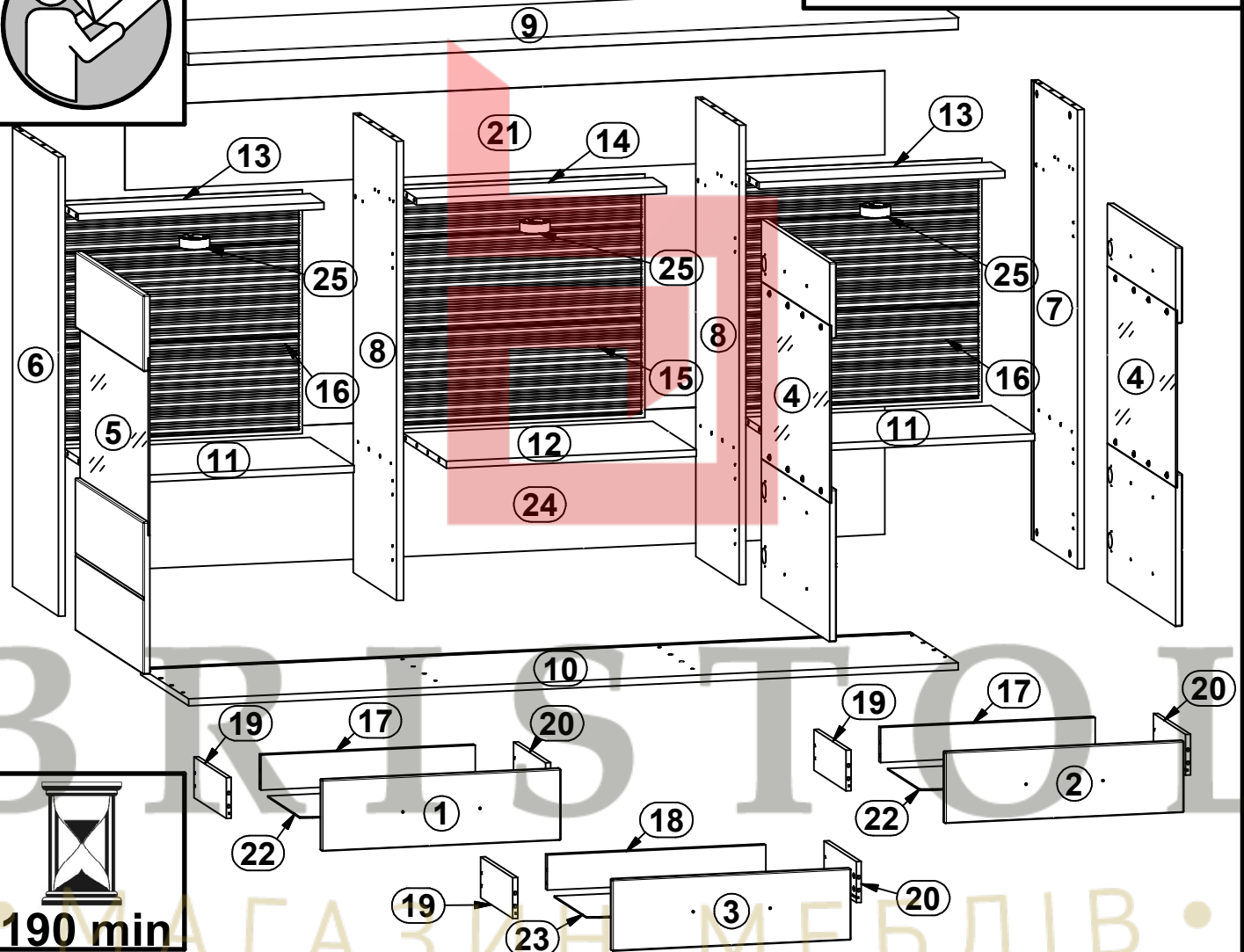
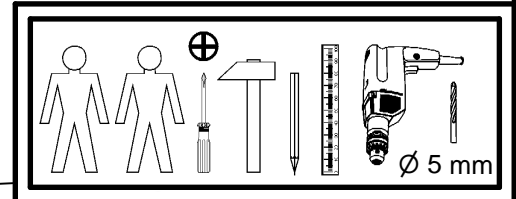

| | | | | | | | | |
|------------|-------------|-------------|-------------|-------------|-----------|-------------|-------------|-----------|
| 6x a44 | 3x a68 | 9x b35 | 6x c306 | 24x e3 | 34x f1 | 12x f25 | 12x j8 | 6x k43 |
| 150x l1 | 14x l2 | 3x m32 | 3x m34 | 22x n108 | 6x o21 | 3x o48\1 | 3x o48\2 | 6x p1 |
| 3x p25 | 3x p35 | 18x p51 | 6x p54 | 22x p55 | 34x r1 | 12x r15 | 46x r16 | 20x s2 |
| 3x t25 | 3x w79\P | 3x w79\L | 1x n26\1 | 10x p38 | | | | |

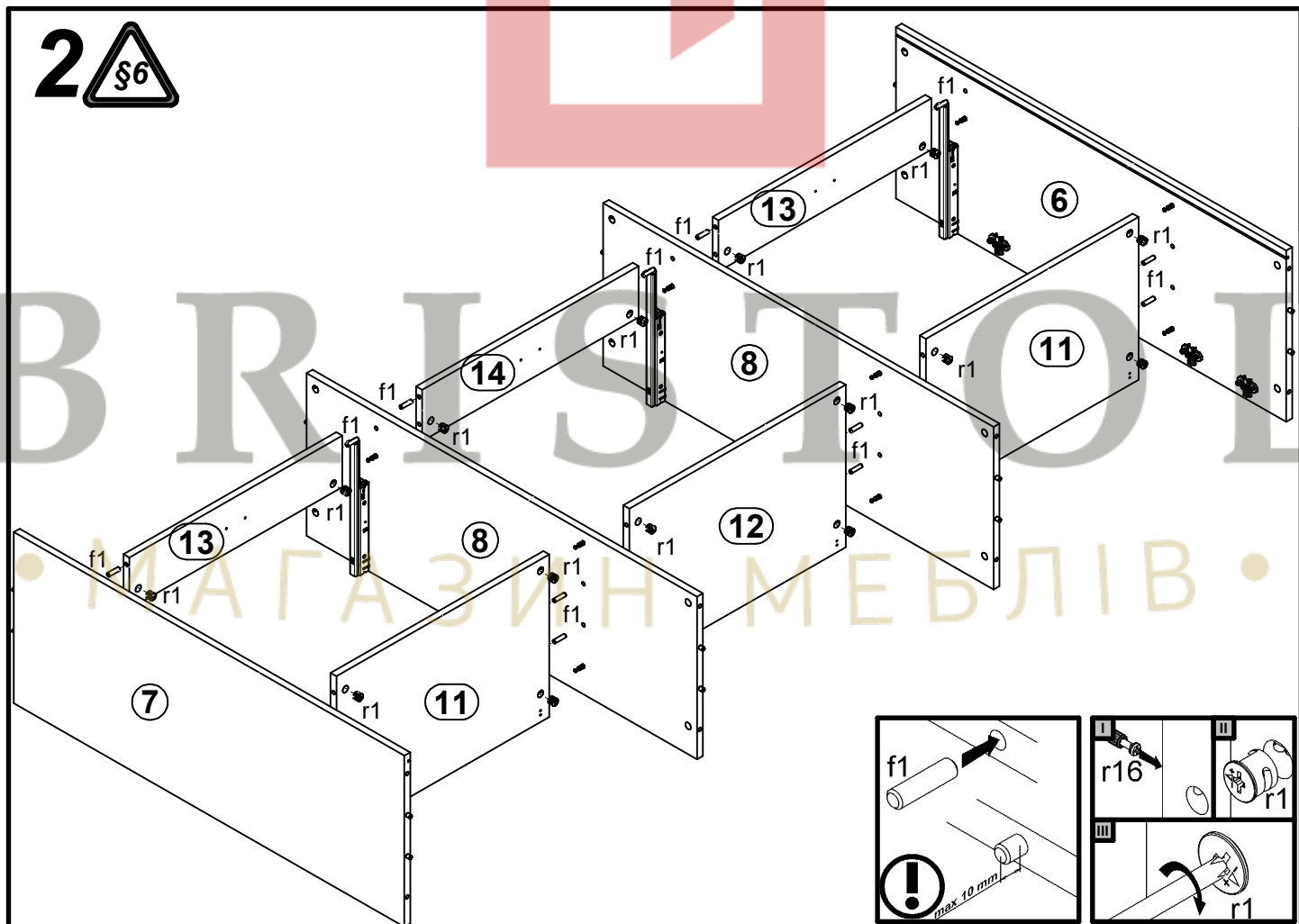
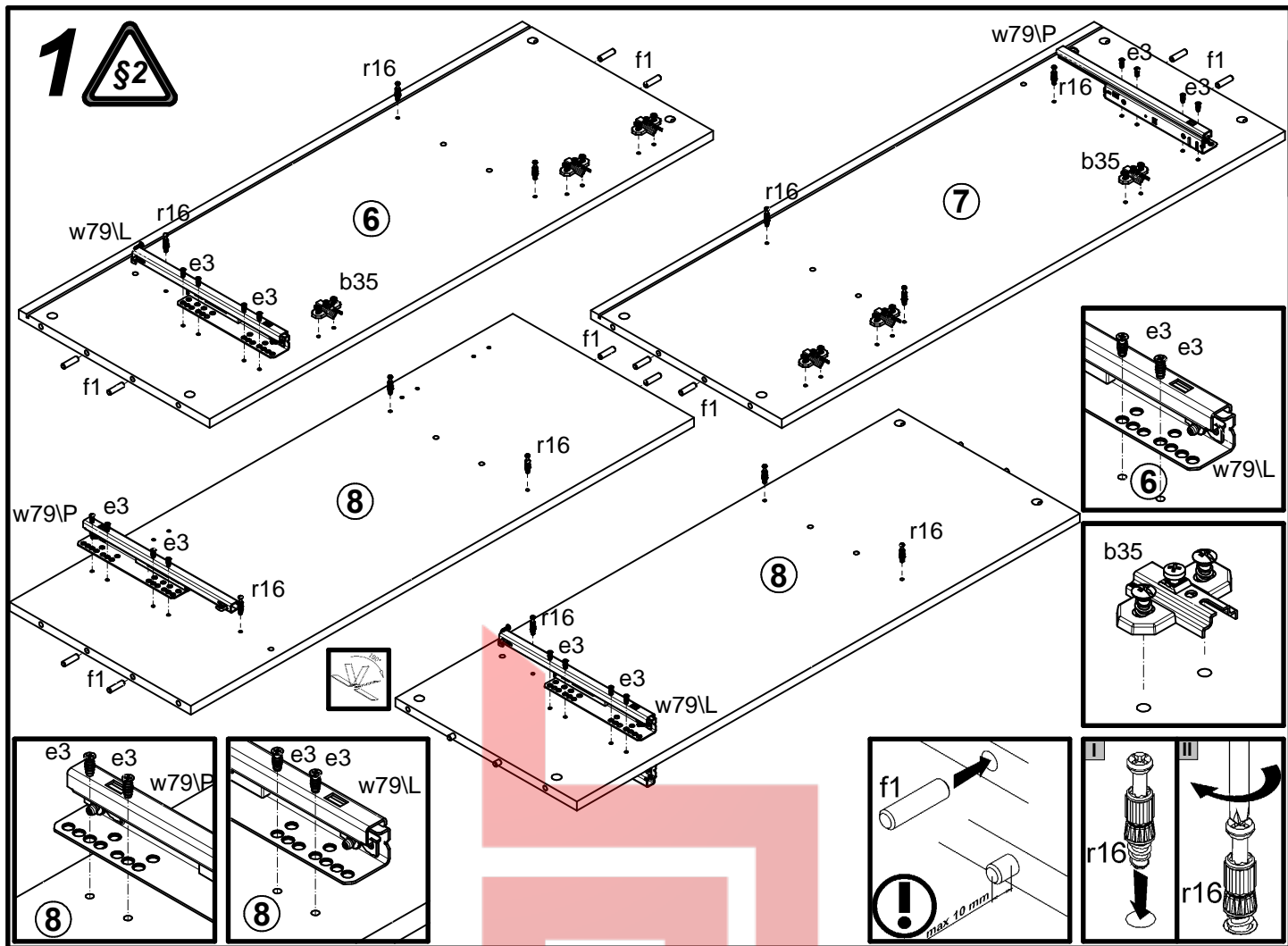

3

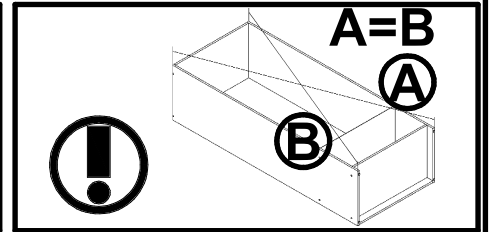
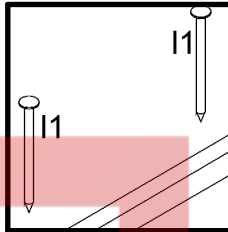
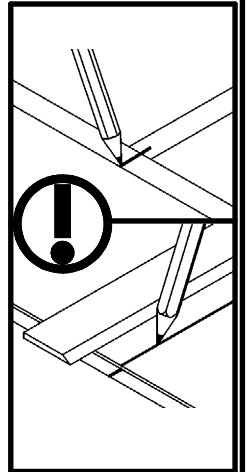
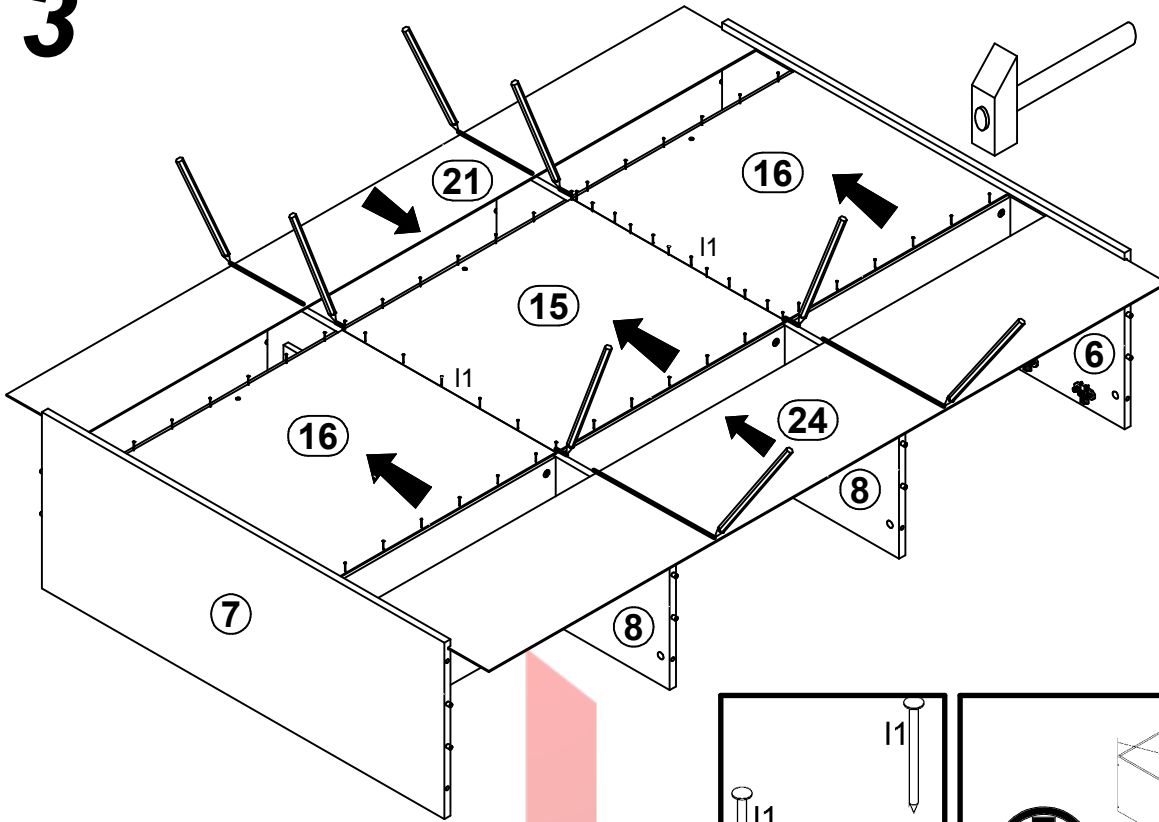

4

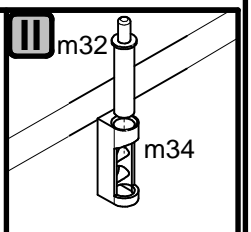
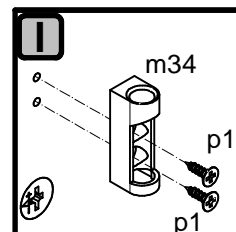
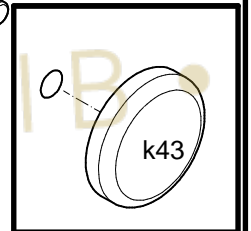
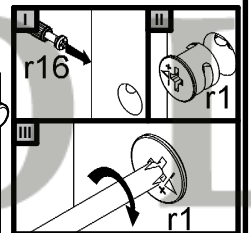
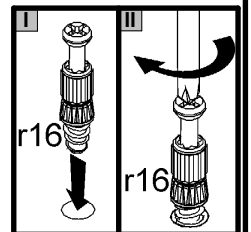
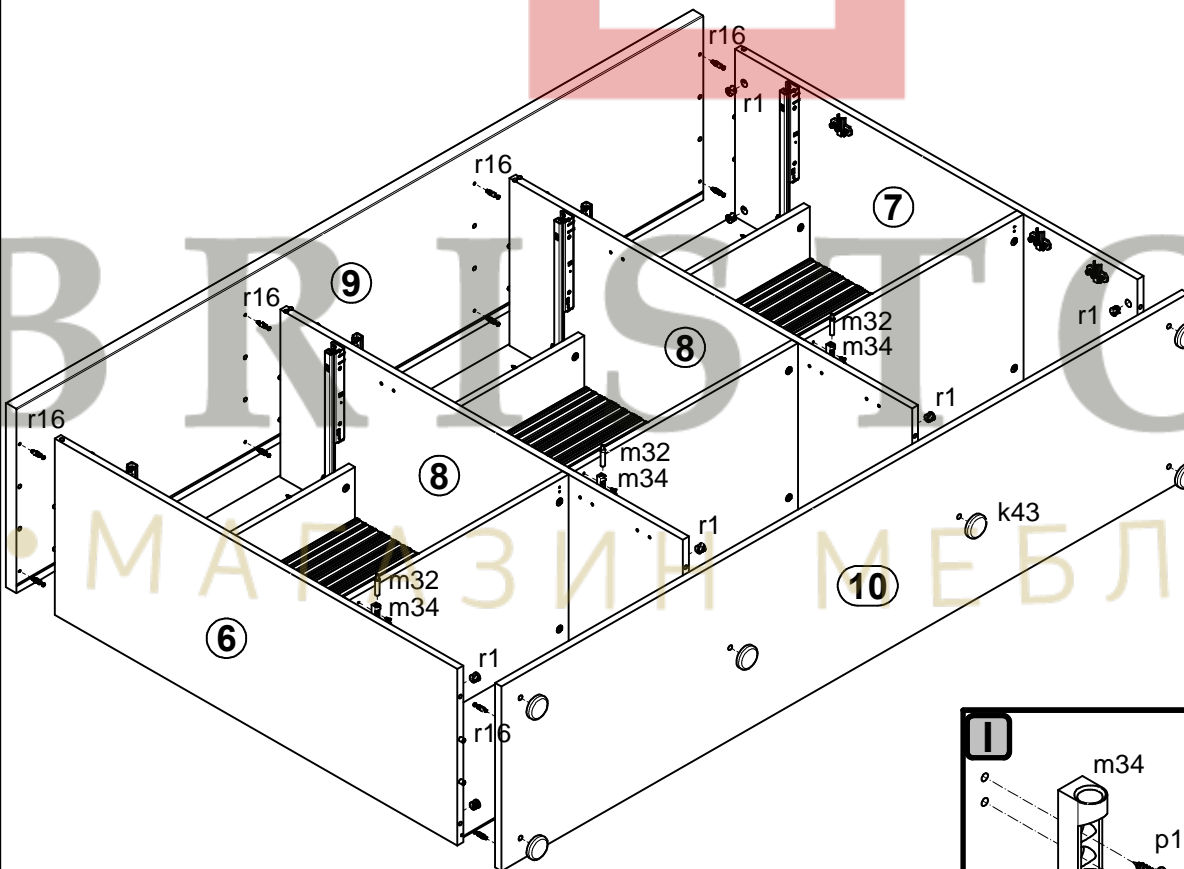

5

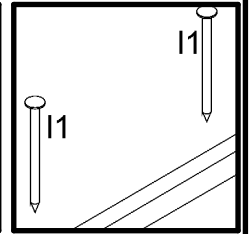
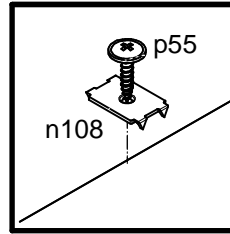
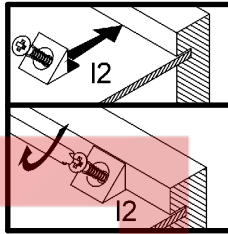
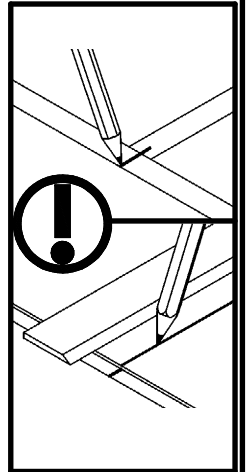
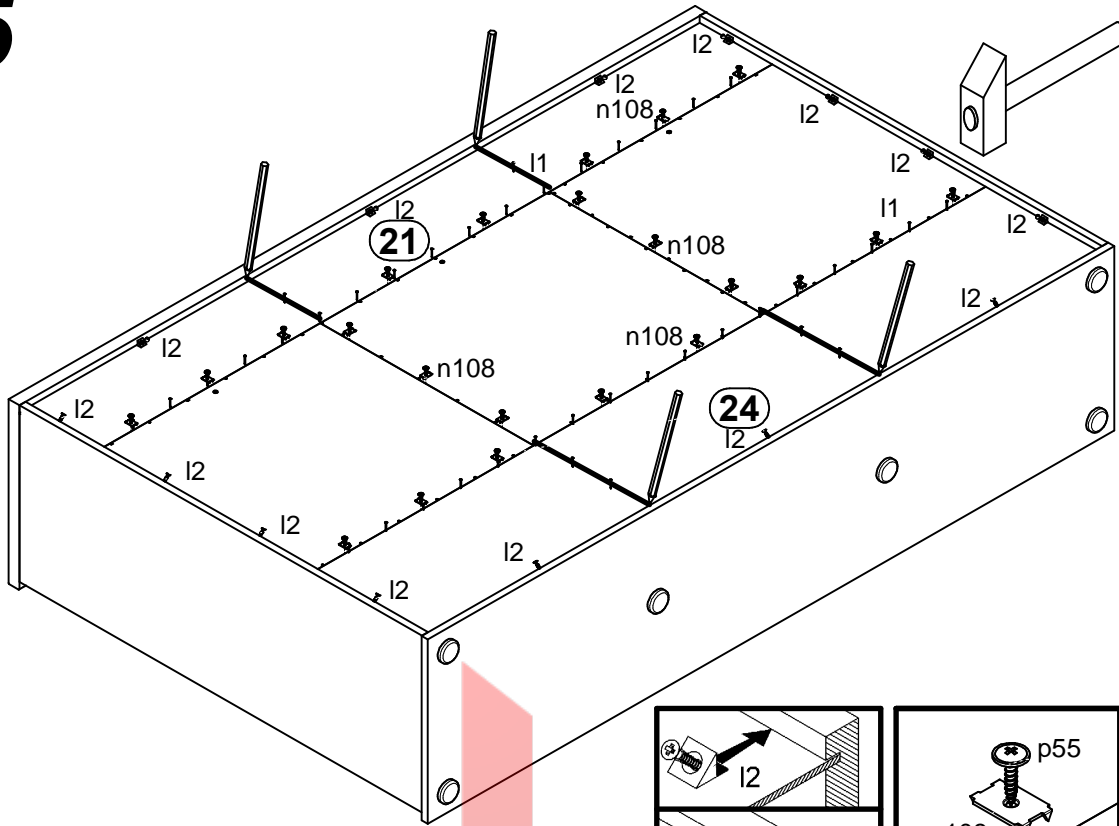

6

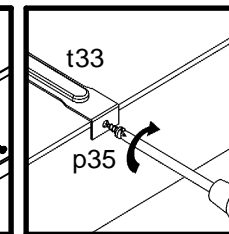
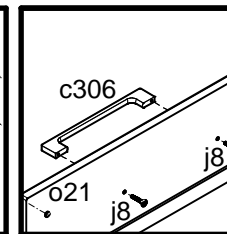
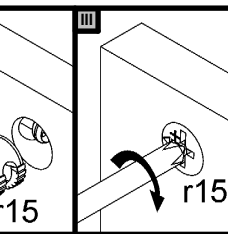
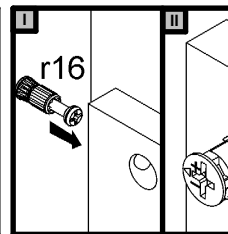
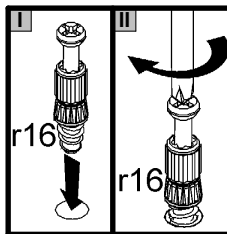
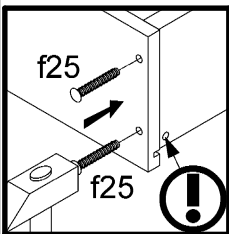
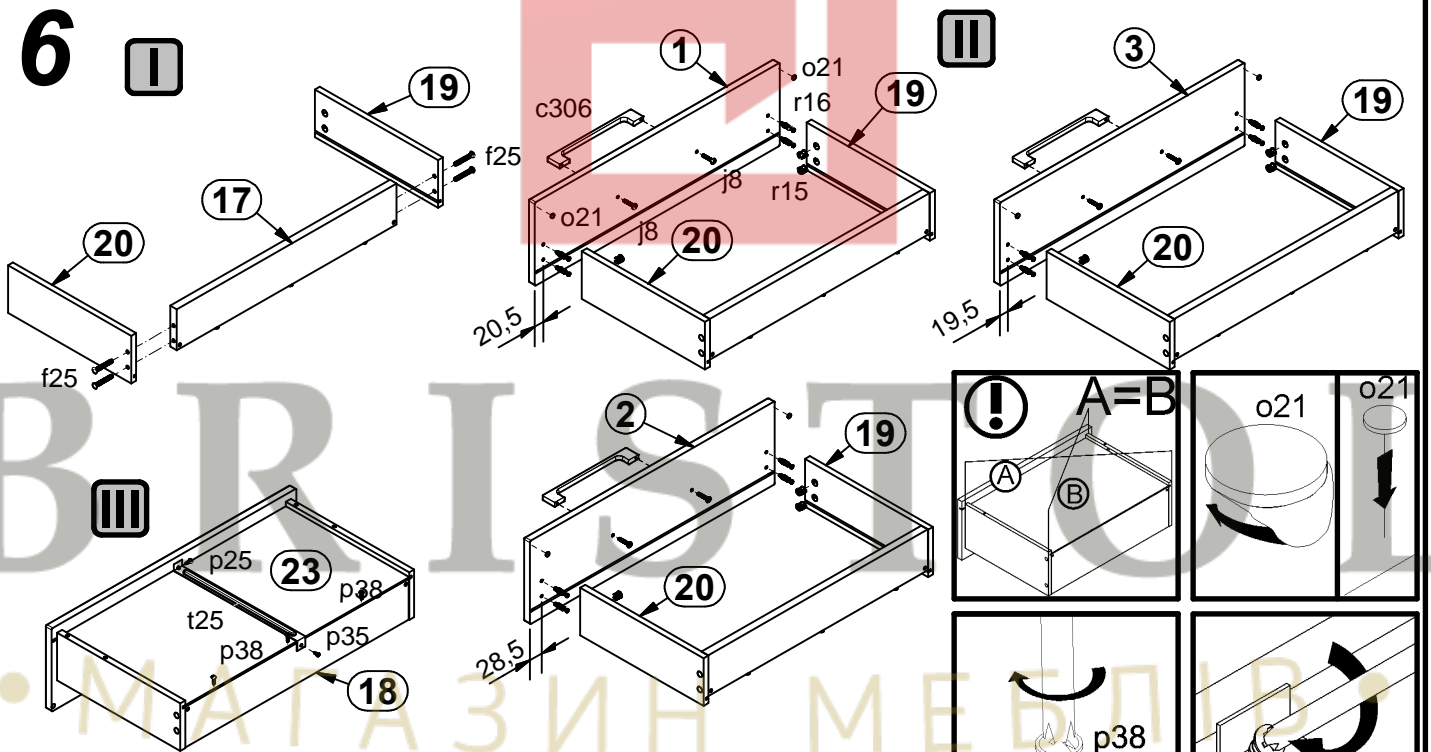

7

