

	A	B	C	D
1	S190-005	1954	546	4/4
2	S190-008	1954	346	4/4
3	S190-113	1926	580	1/4
4	S190-114	1926	580	1/4
5	S190-209	900	580	2/4
6	S190-210	900	580	2/4
7	S190-303	867	564	2/4
8	S190-552	1100	80	3/4
9	S190-911	1940	440	1/4
10	DR-862	862		2/4
11	LH-1925	1925	14	1/4

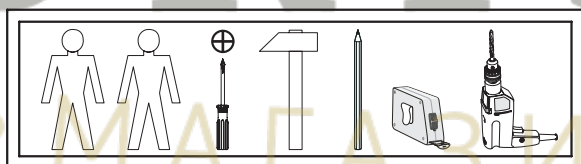
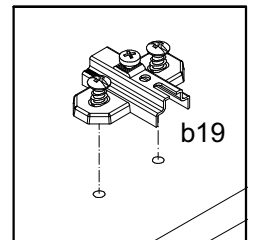
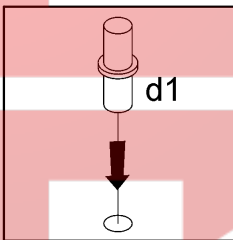
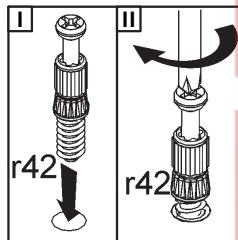
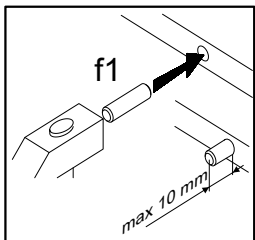
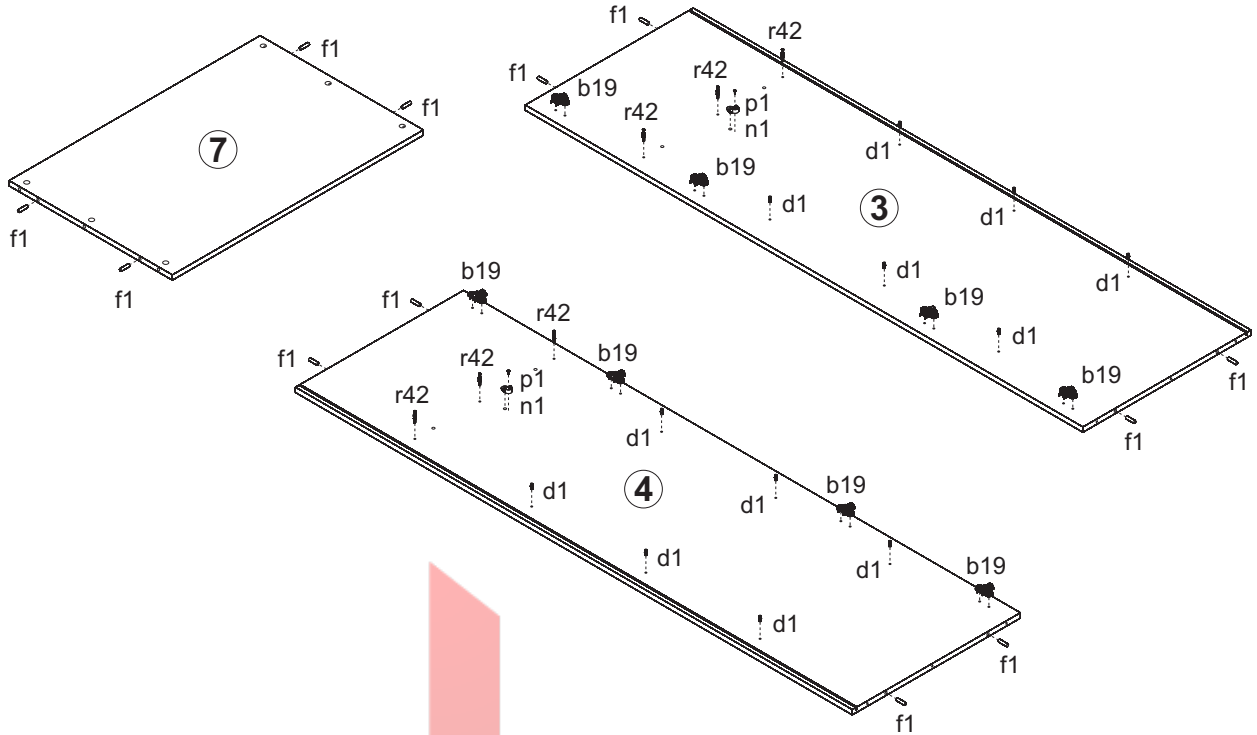
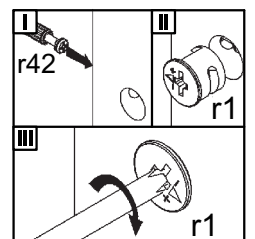
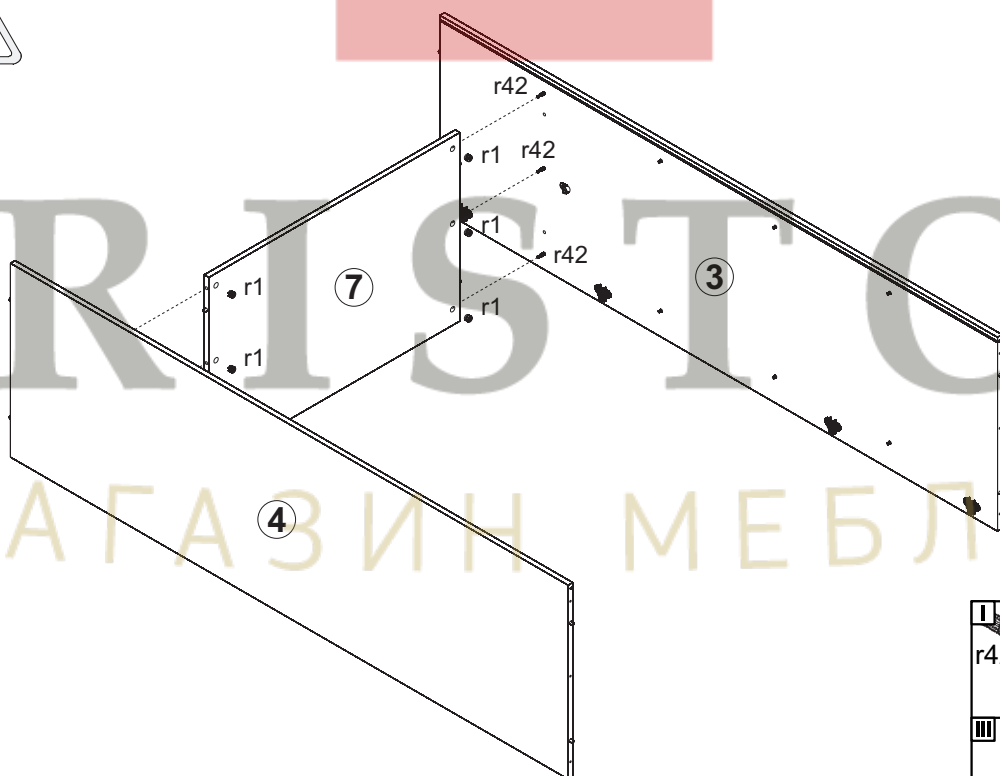

	A	B	C	D
12	S190-304	867	559	1/1

8x  a44	8x  b19	12x  e1 φ7x50 mm	8x  e3 φ6x13 mm	12x  f1 φ8x30 mm	4x  k8211	4x  k8212	10x  l1
24x  l2	2x  n1	1x  n2611	2x  p1 φ3,5x13 mm	1x  p38 φ3,5x16 mm	16x  p51 φ3,5x15 mm	4x  p94 φ4x28 mm	6x  r1 φ15x12mm #16
6x  r42 20/11	6x  s2 φ16	1x  z1				12x  d1 φ5x17 mm	

**1****2**

3

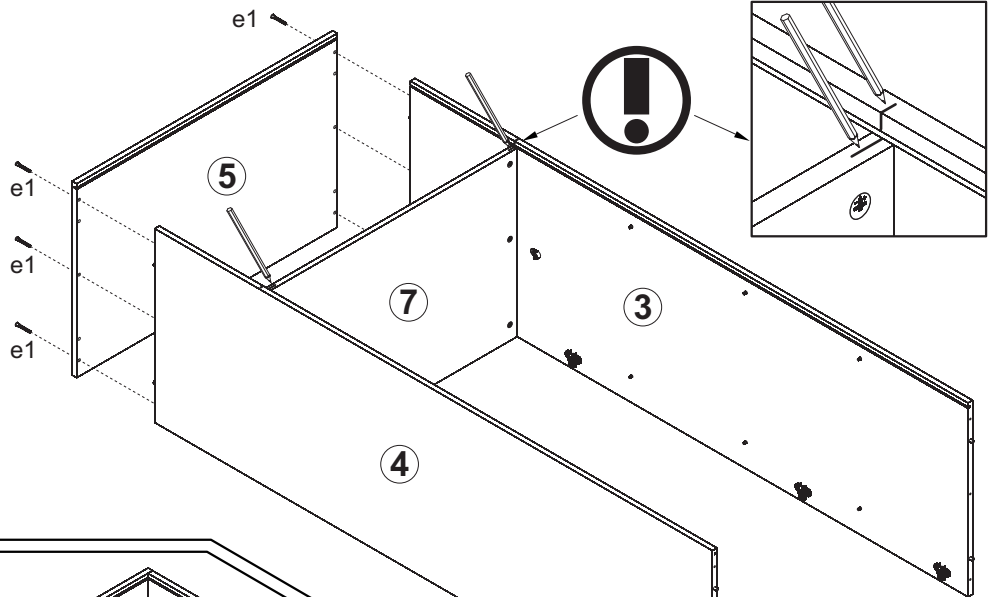
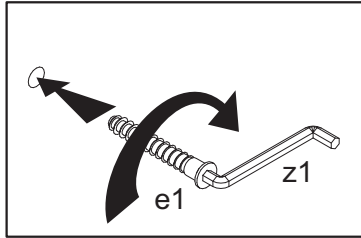

4

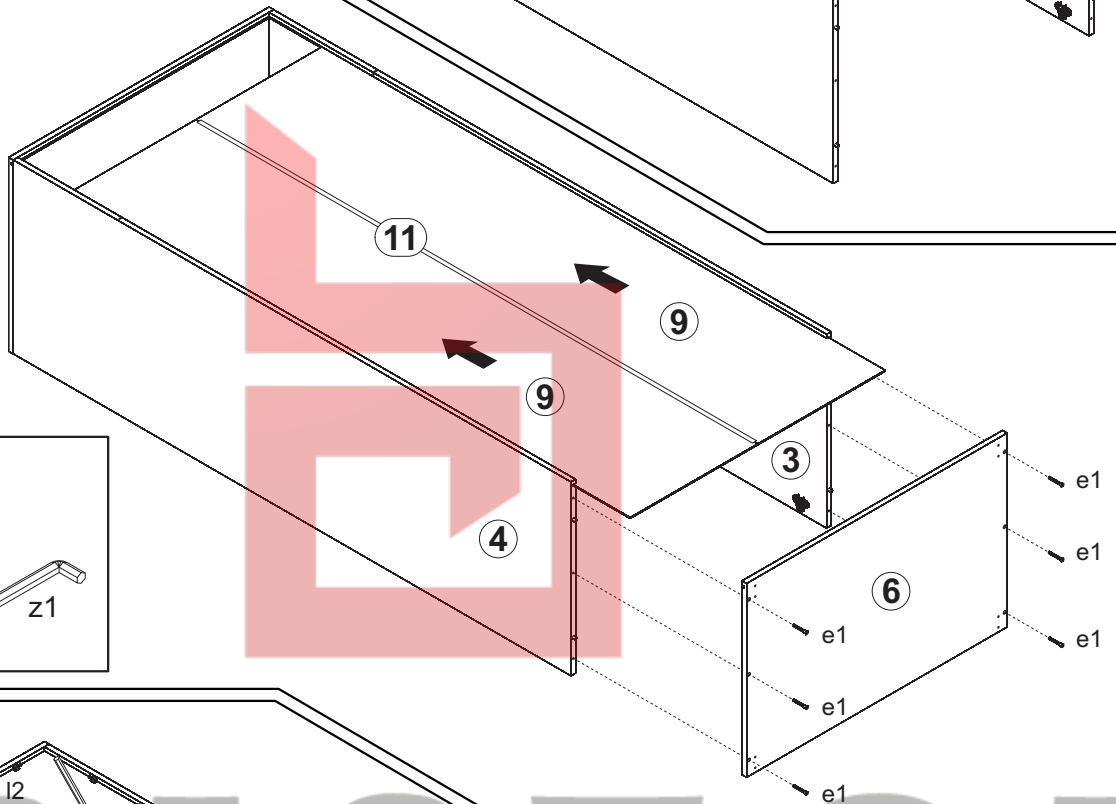
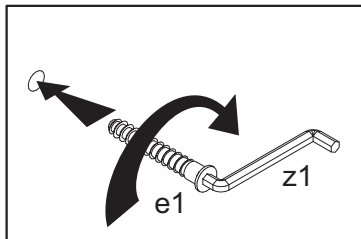

5

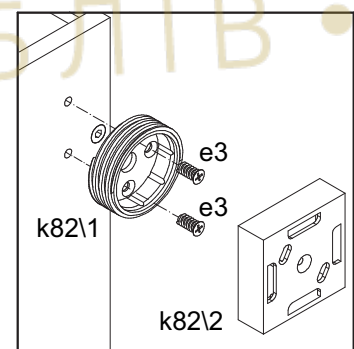
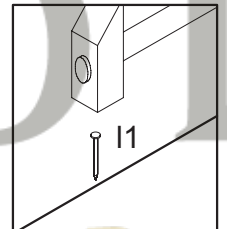
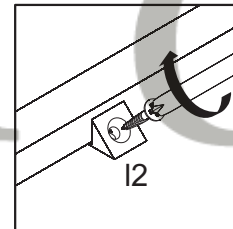
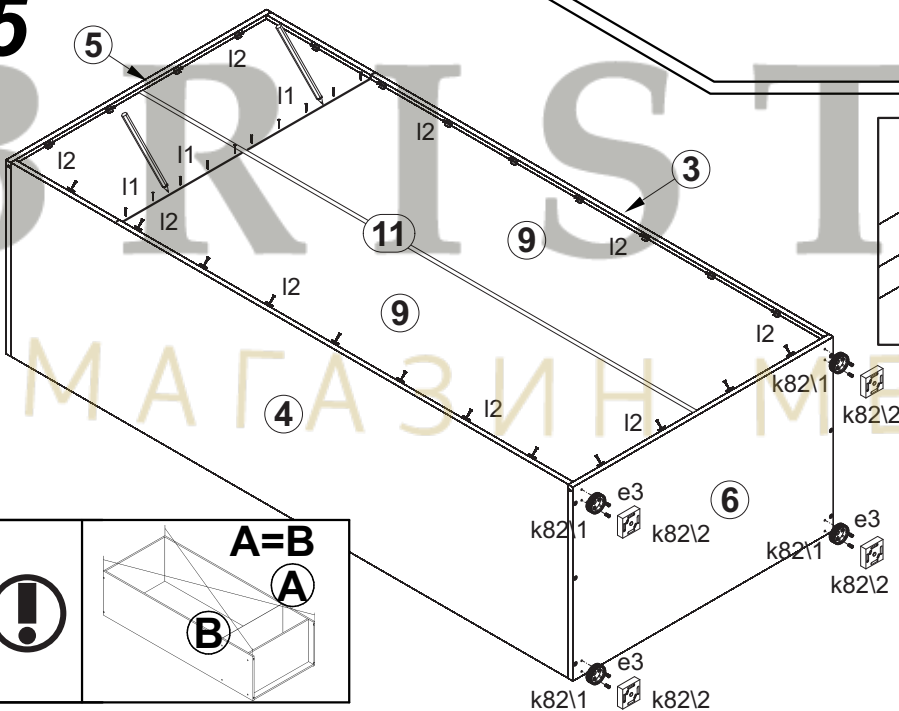
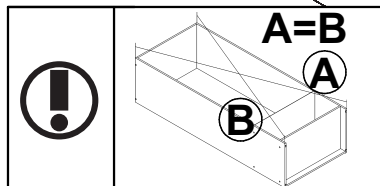

6

