

ВУШЕР

Вітрина / Витрина - REG1D1W_L/P

A	B	C	D	
1	S154-107	1218	360	1/1
2	S154-121	1218	360	1/1
3	S154-132	1218	340	1/1
4	S154-224	800	360	1/1
5	S154-223	800	360	1/1
6	S154-317	375	330	1/1

A	B	C	D	
7	S154-316-01	374	330	1/1
8	S154-004	396	1246	1/1
9	S154-001	1246	396	1/1
10	S154-925	1228	388	1/1
11	S154-926	1228	388	1/1

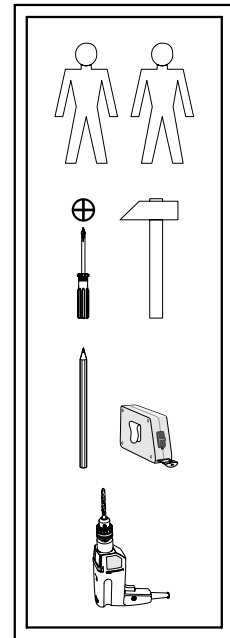
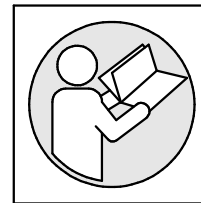
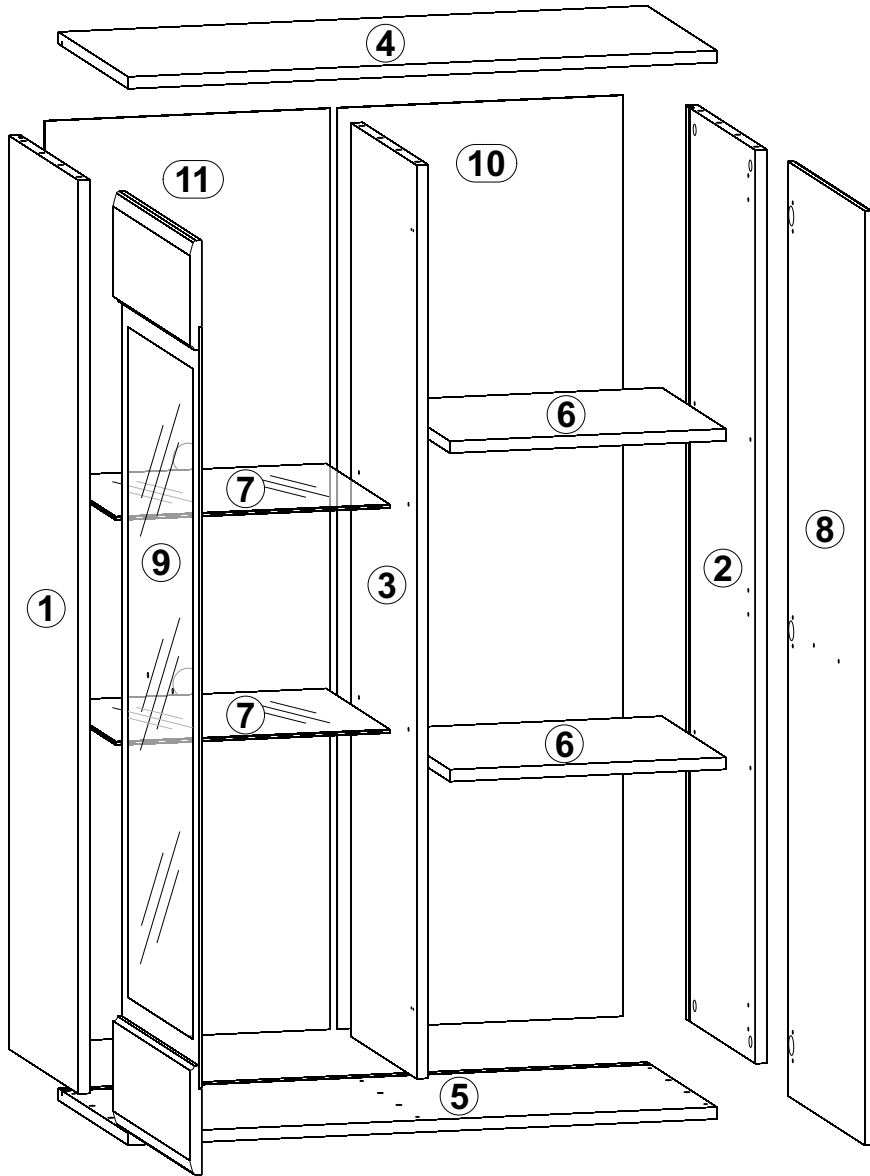
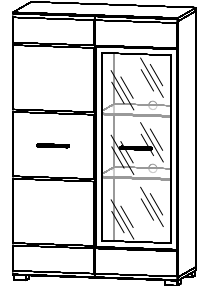
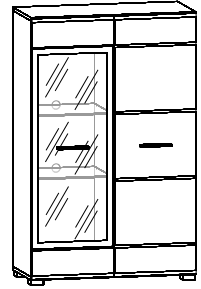
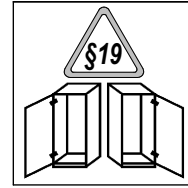

3x KO a2	2x KO a44	3x b1	2x D3 b35	2x c253 ³	8x φ5x17 mm d1	8x φ5x17 mm d3	12x φ8x30 mm f1	5x k55	
25x l1	12x l2	1x φ8/35x11mm m32	1x m34	1x n26/1	4x siikon φ8x1,8mm o21	2x φ6,5/φ10x5,2mm o27	1x o43/6		
2x o43/1	2x φ3,5x13 mm p1	10x φ4x35 mm p6	2x φ4x30 mm p9	1x φ3,5x16 mm p38	2x φ4x12 mm p59	4x φ3,5x15 mm p51	12x φ15x12mm #16 r1	12x 209 r16	
12x φ16 s2	2x φ40 s53	2x φ40 s53							

1  

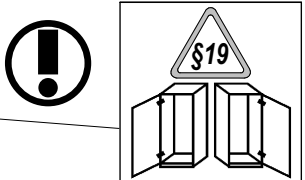
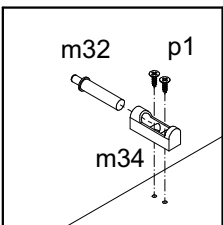
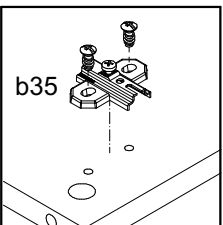
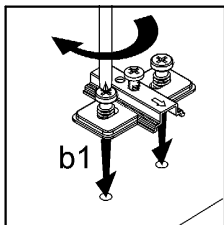
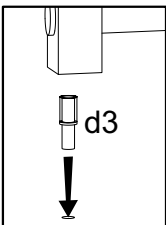
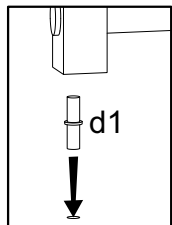
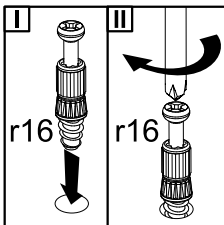
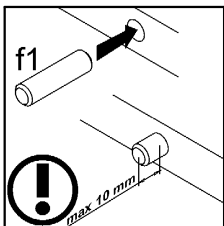
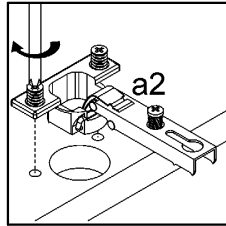
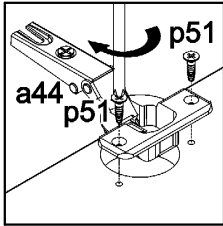
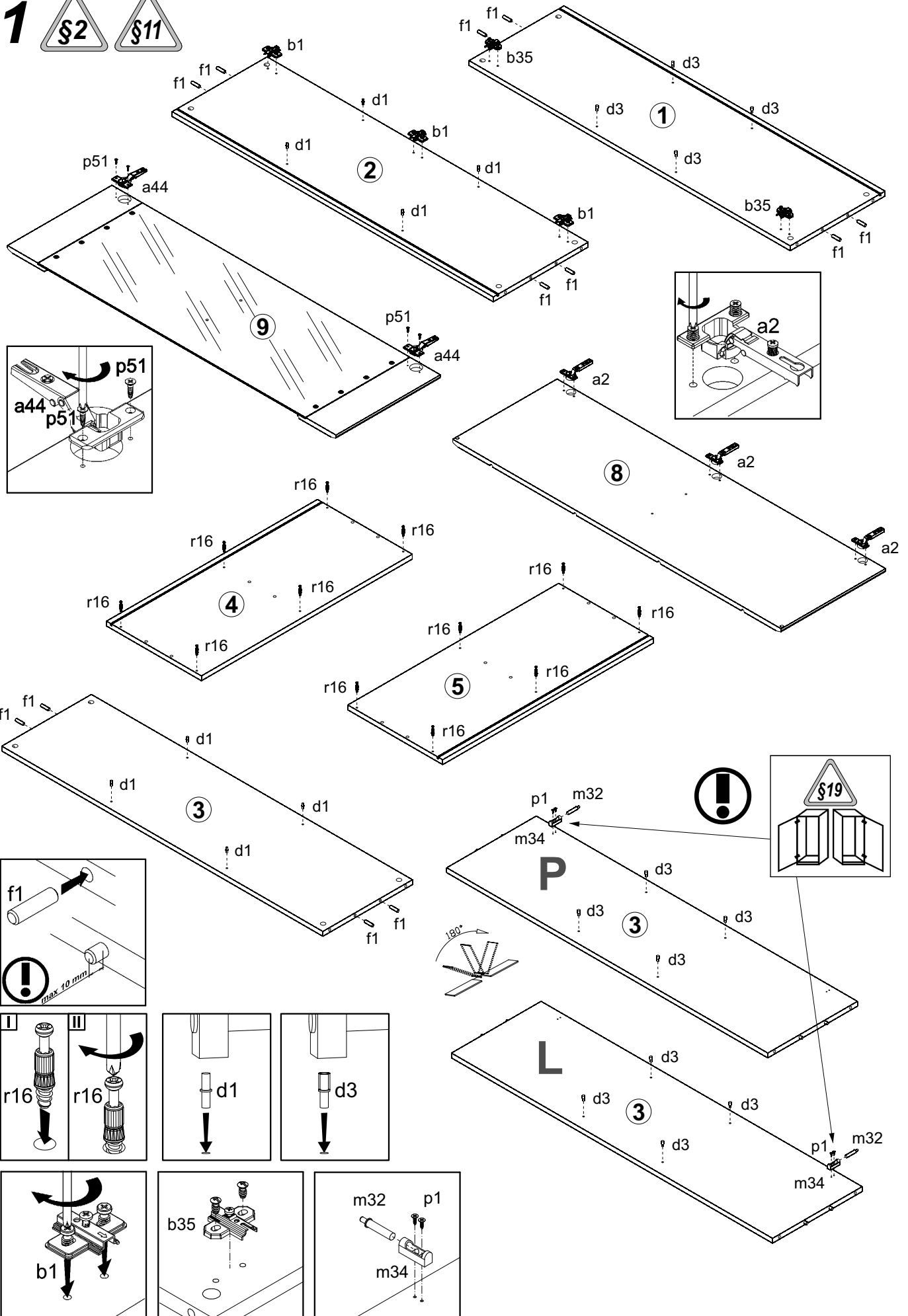

2 L



REG1D1W_L

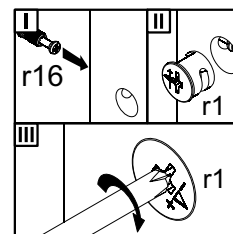
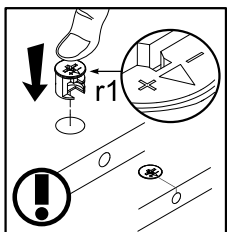
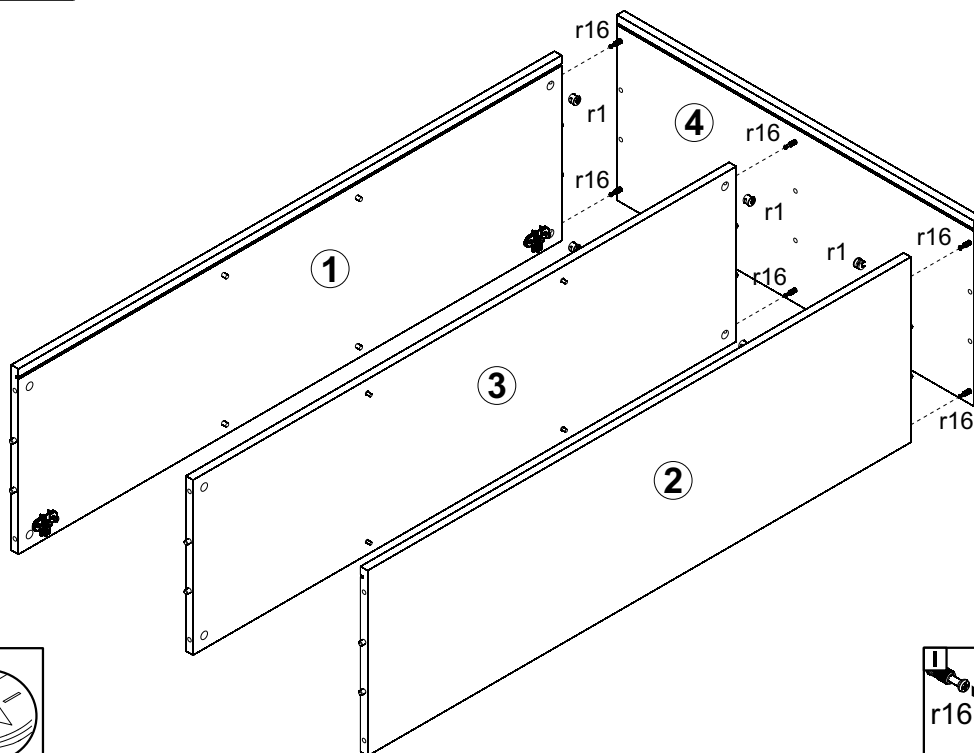

2 P



REG1D1W_P

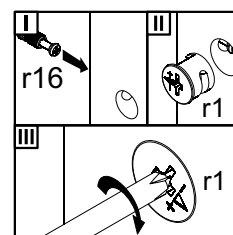
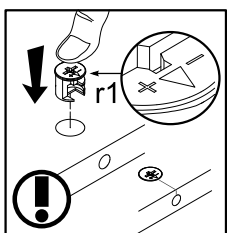
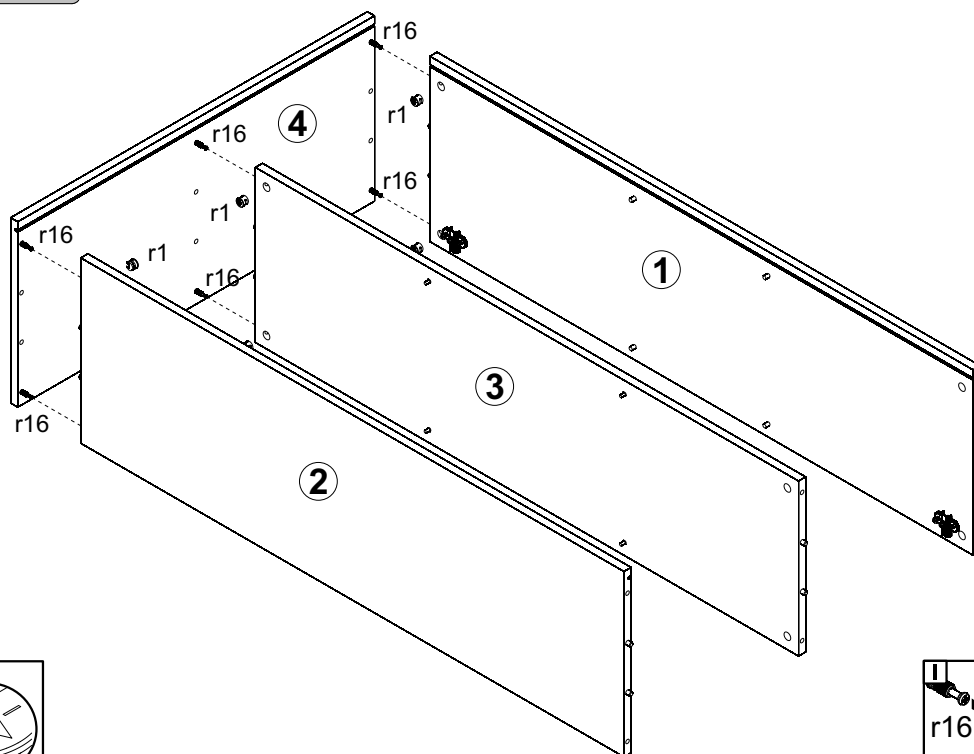

3 L

REG1D1W_L

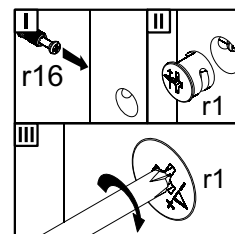
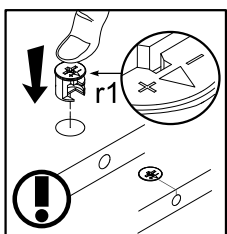
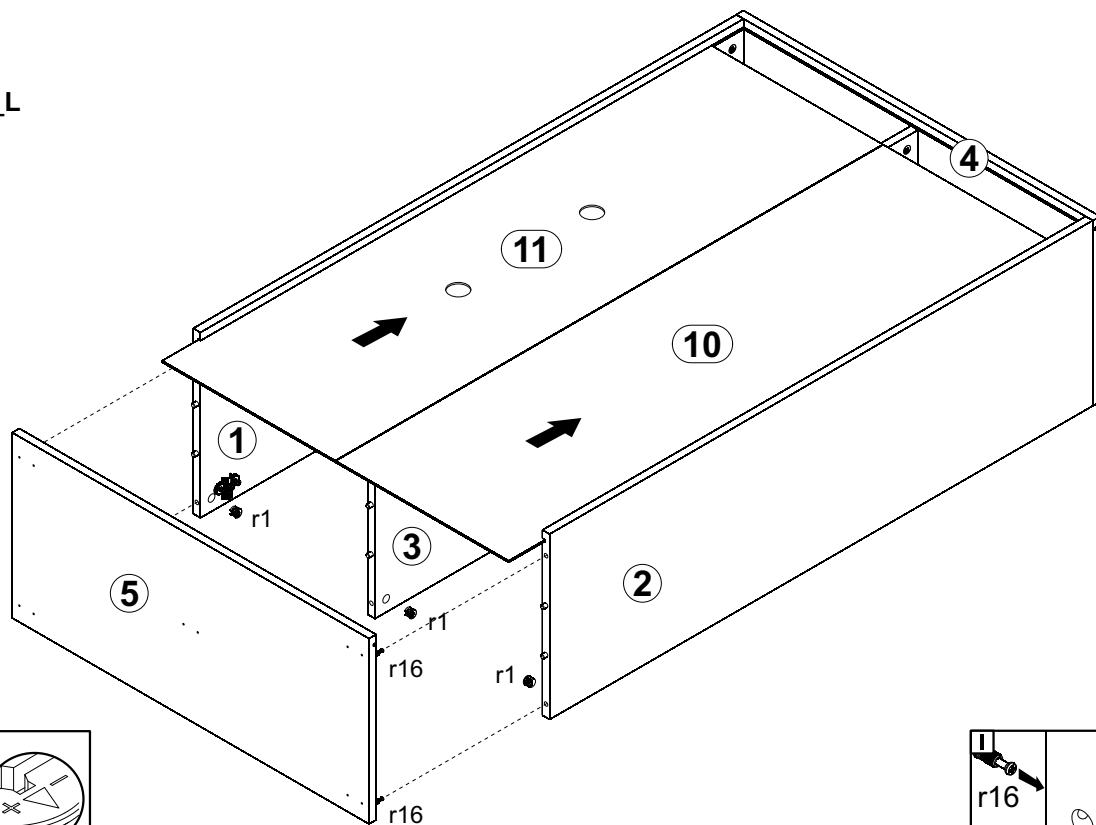

3 P

REG1D1W_P

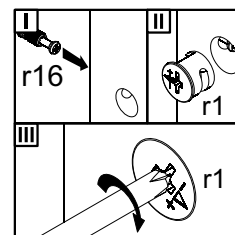
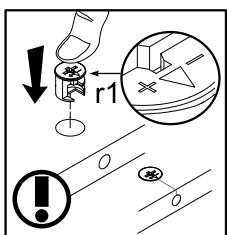
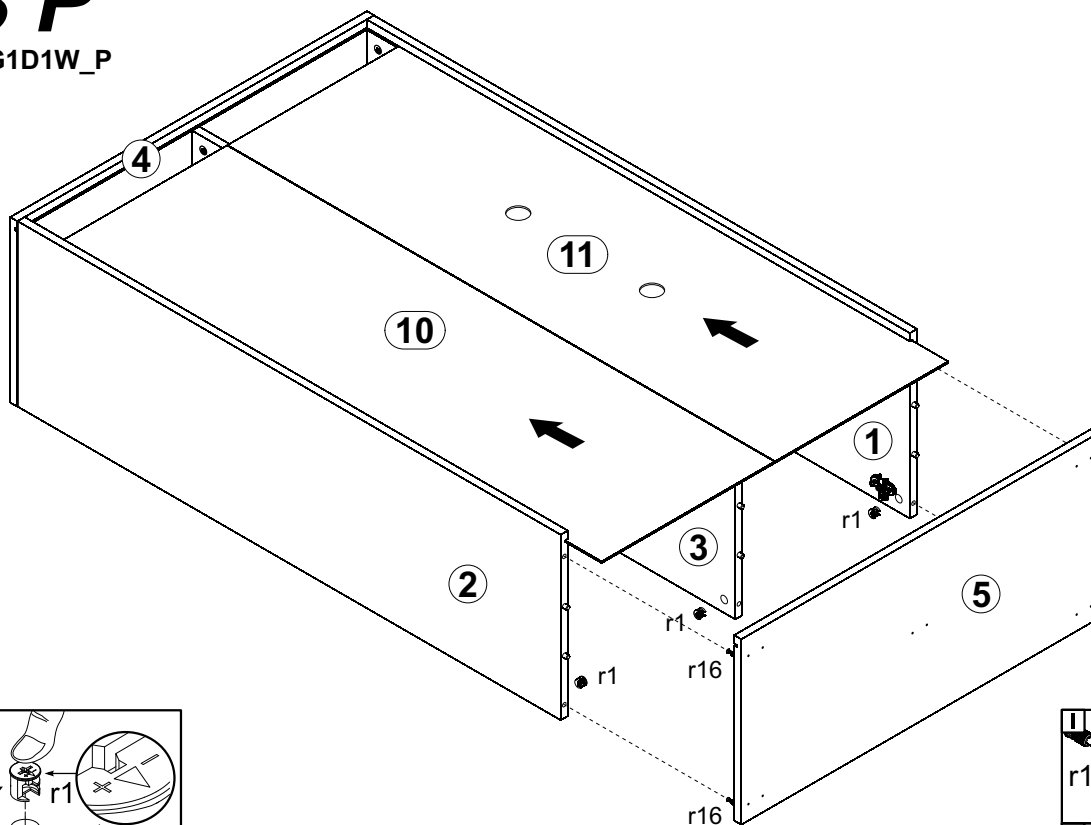

4 L

REG1D1W_L

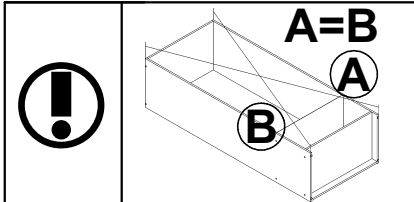
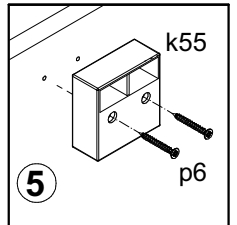
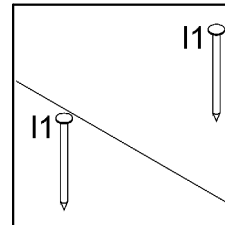
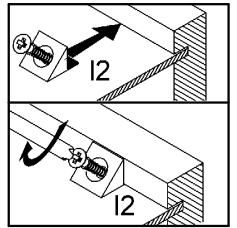
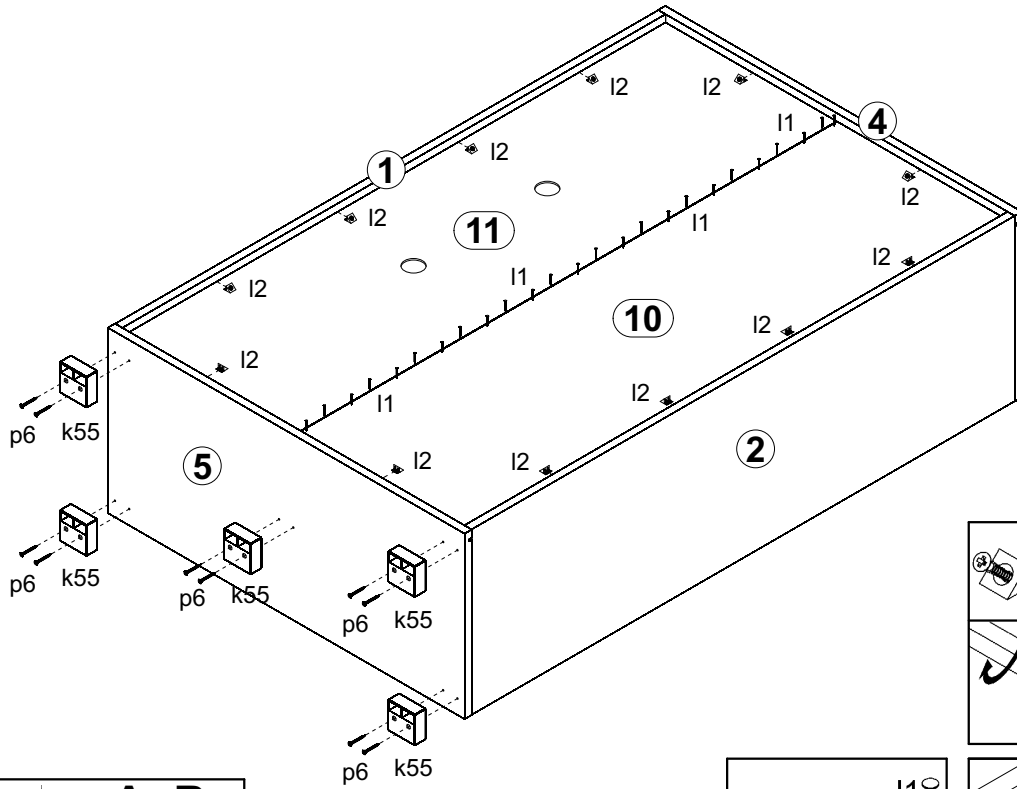

4 P

REG1D1W_P

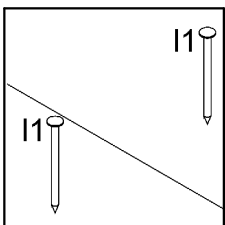
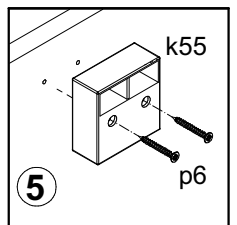
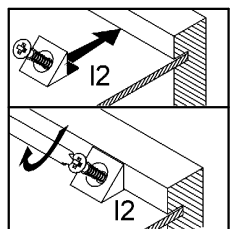
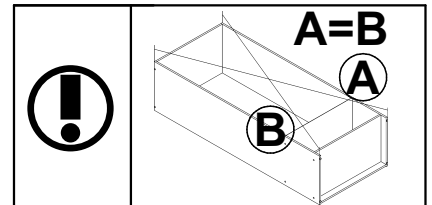
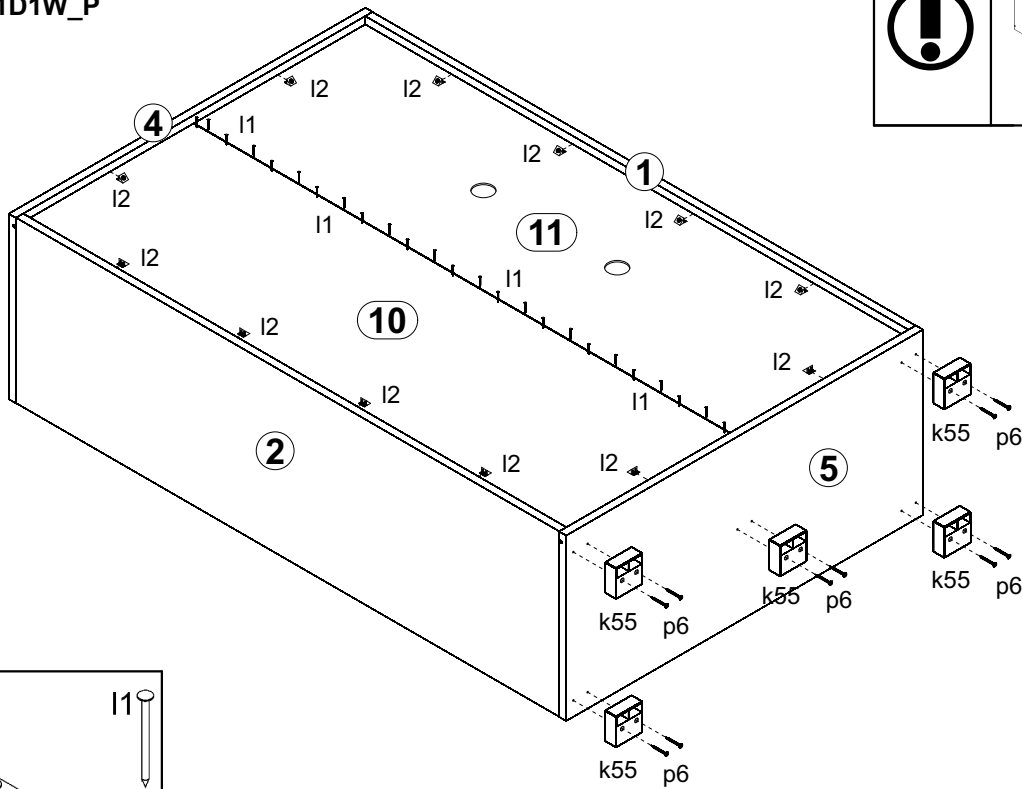

5 L

REG1D1W_L

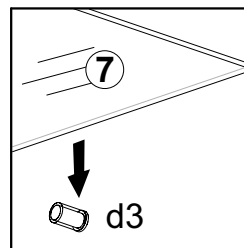
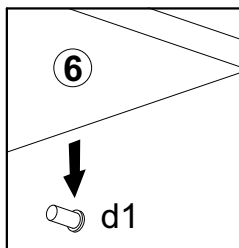
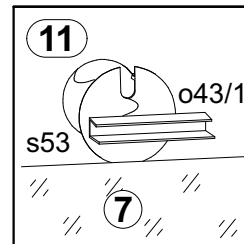
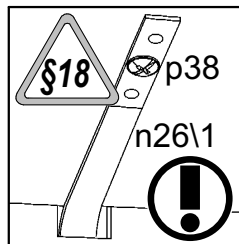
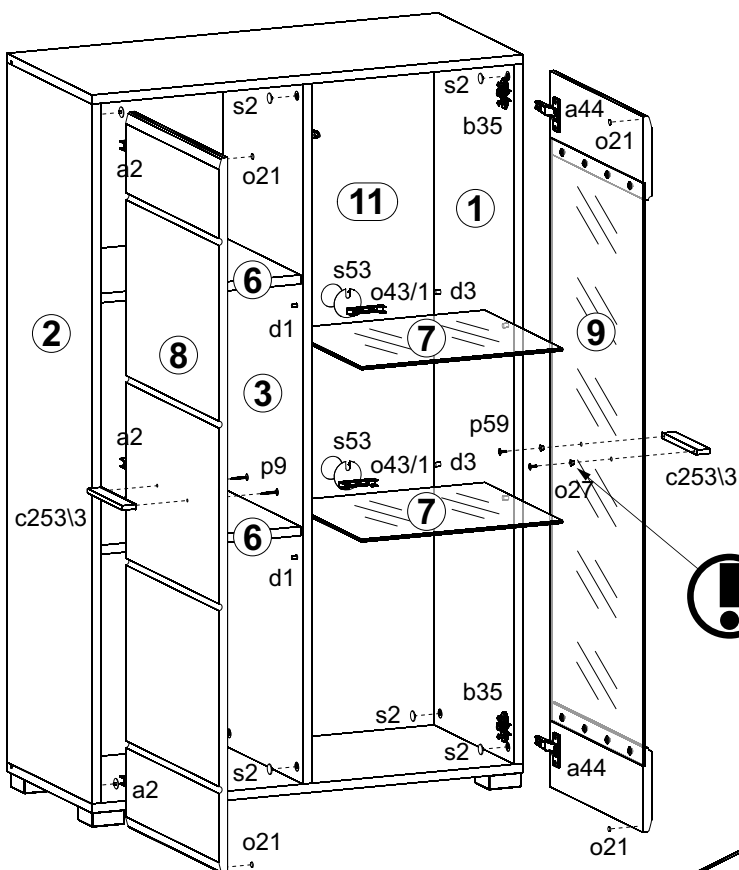

5 P

REG1D1W_P

