

**A**

# ZLATA

**SFW1K**

A	B	C	D
1	S383-00020	1345	330 2/2
2	S383-11026	340	285 1/2
3	S383-11027	340	285 1/2
4	S383-11028	340	265 1/2
5	S383-22019	1350	303 1/2
6	S383-22020	1350	303 1/2
7	S383-99008	1328	352 2/2

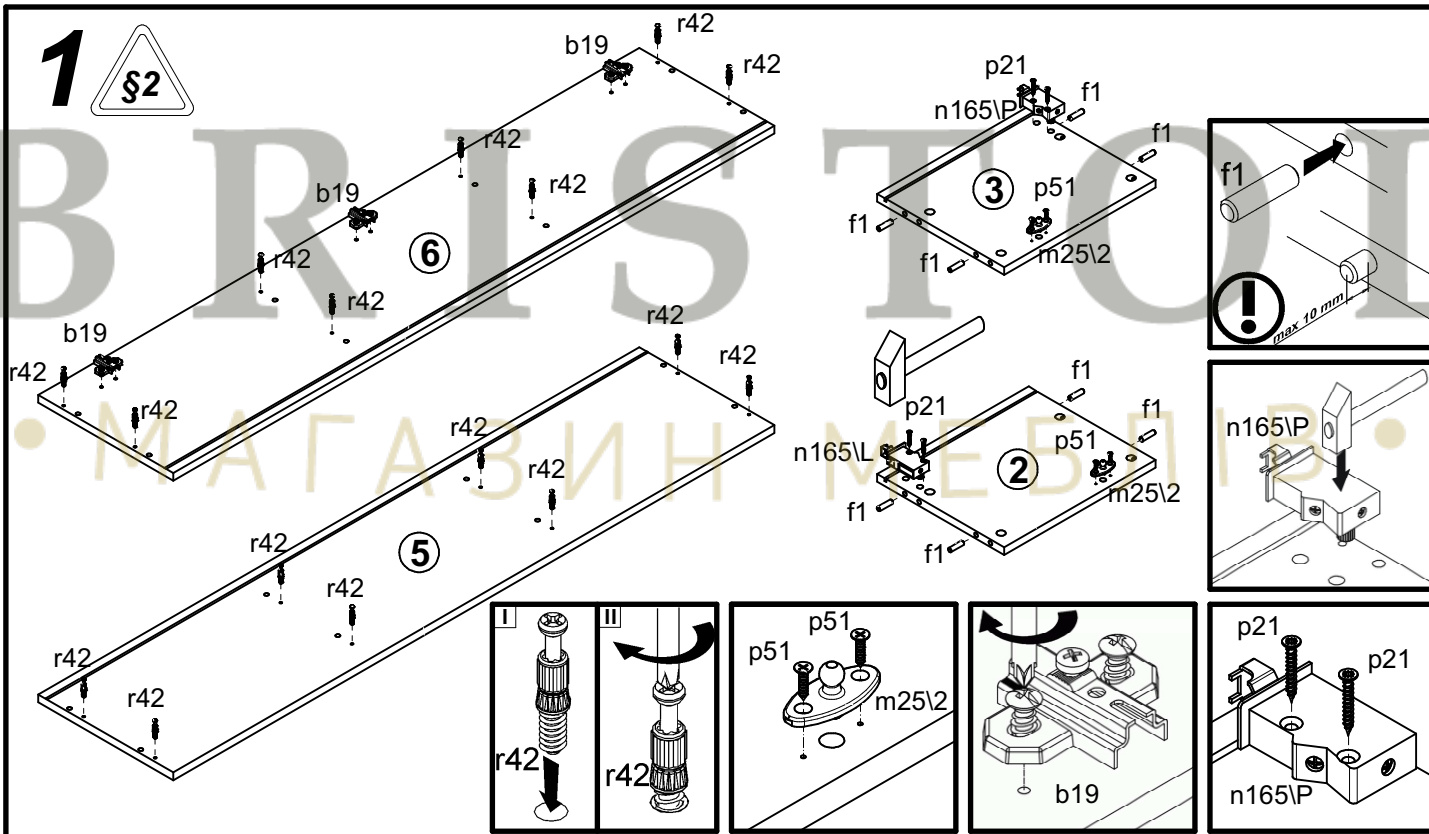
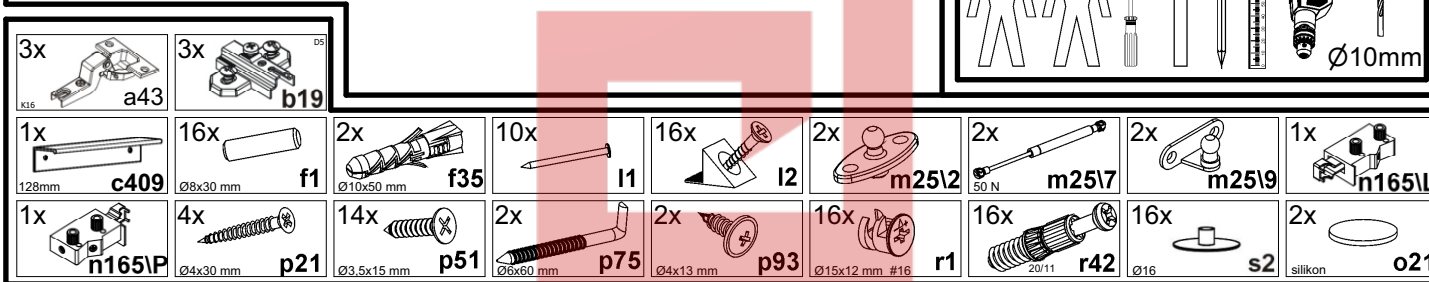
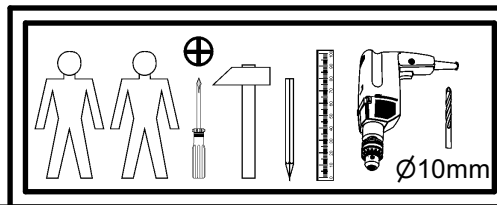
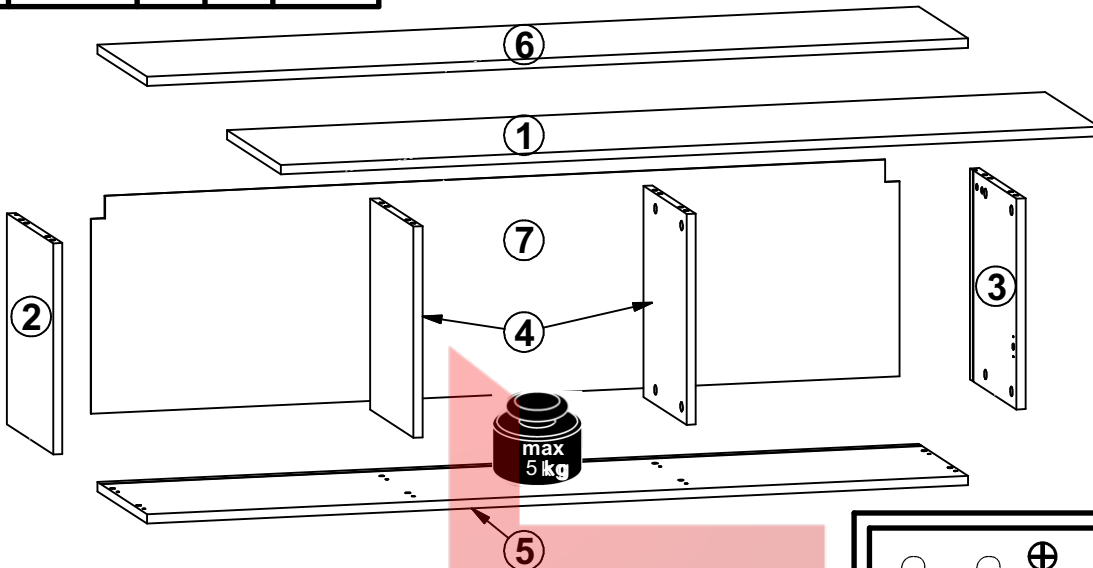
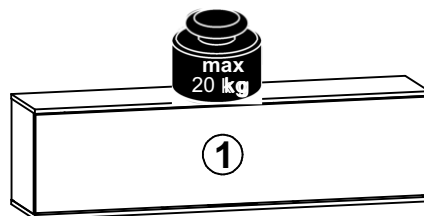

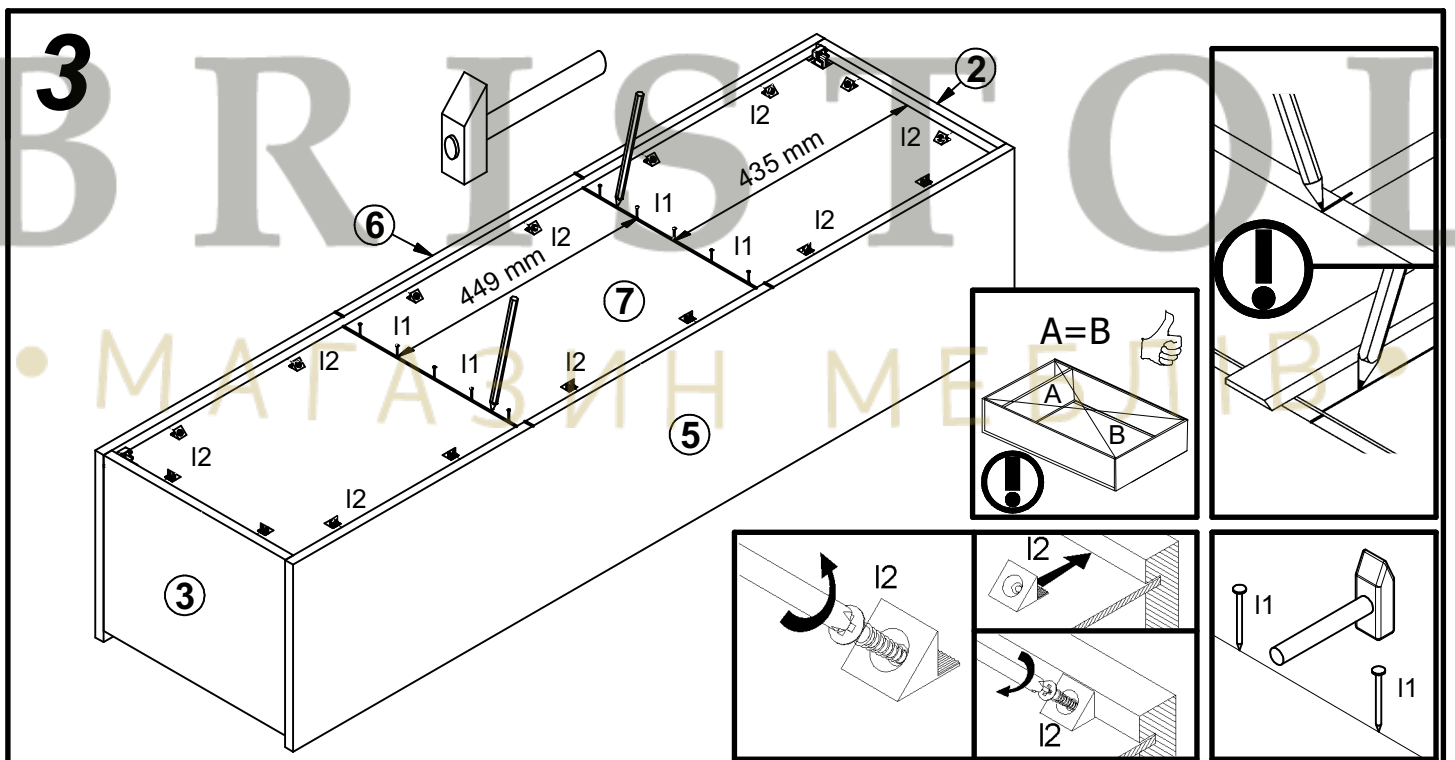
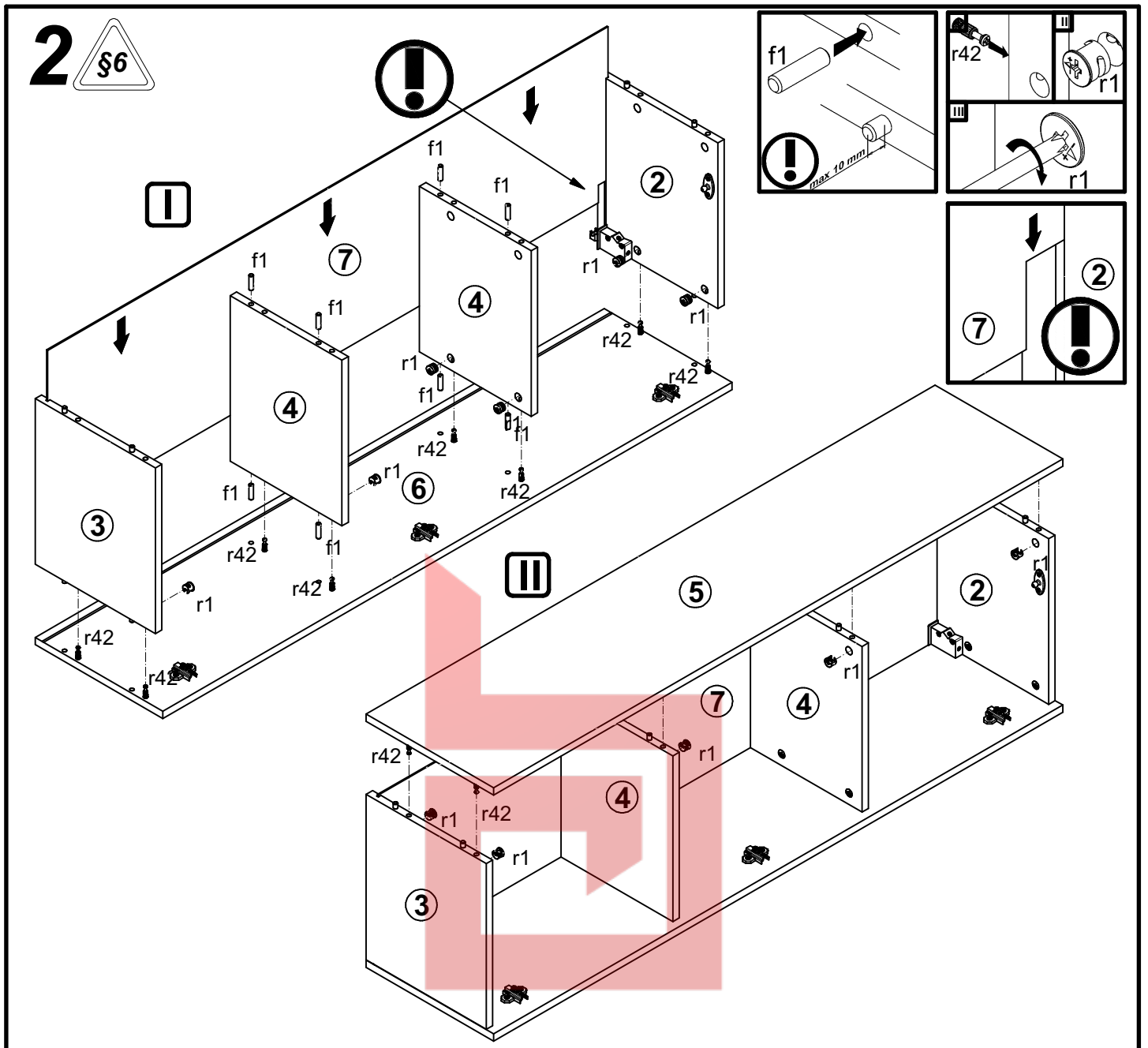

# 4

φ10 mm

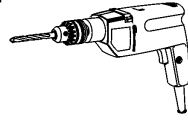

f35

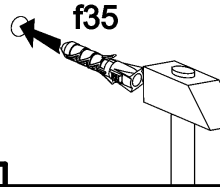

f35

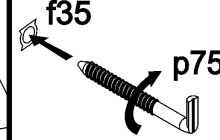

f35

p75

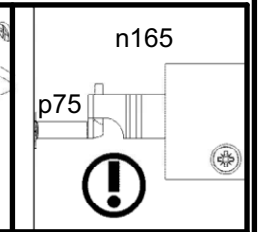
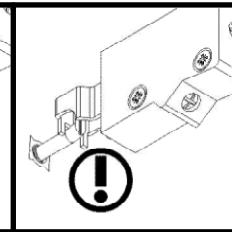
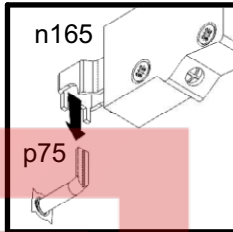
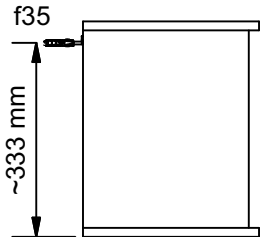
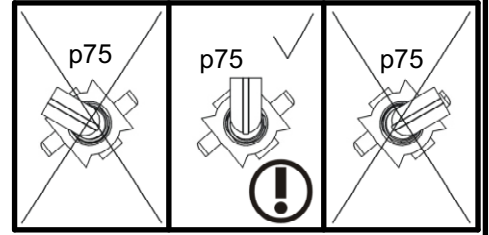
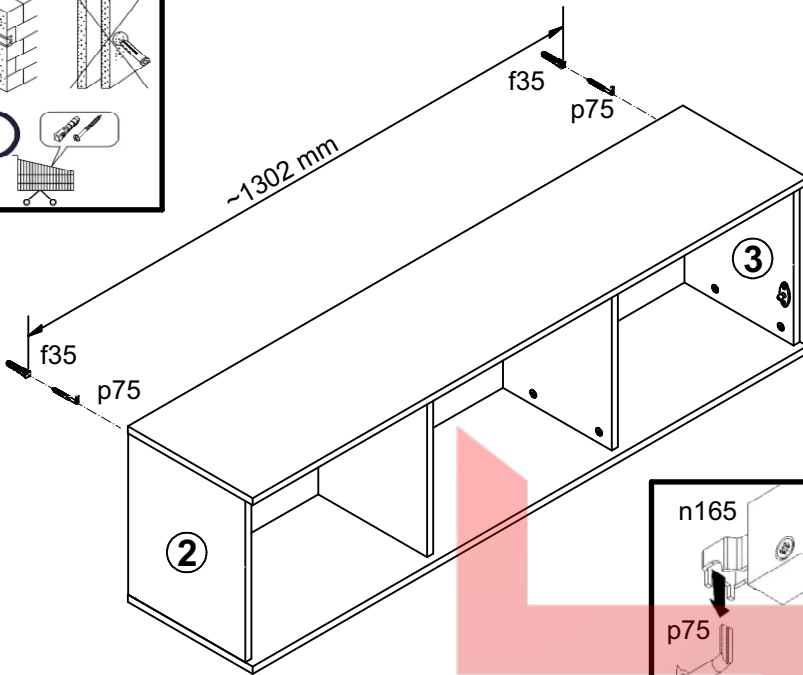
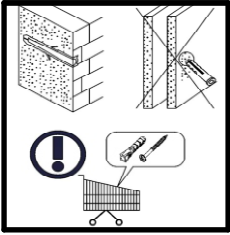
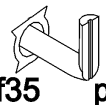

# 5

I

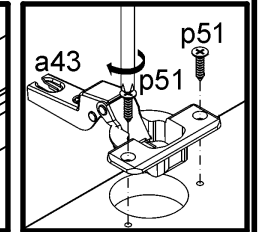
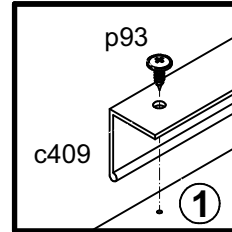
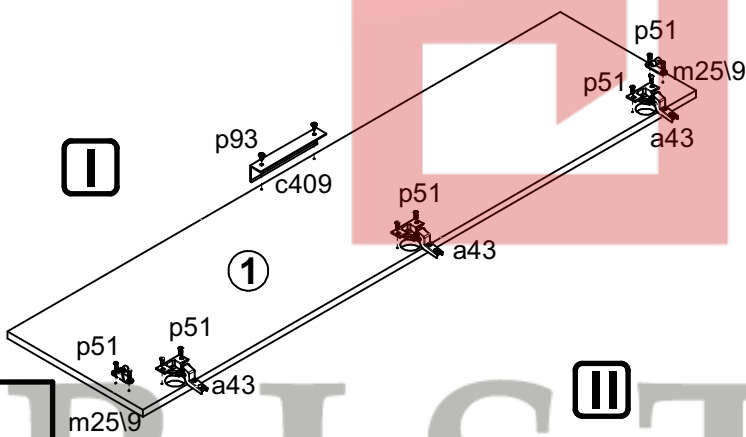

II

