

**A**

**ZLATA**

**REG1W1D/90**

A	B	C	D
1	S383-00018	1272	394
2	S383-00019	1272	496
3	S383-11023	1280	385
4	S383-11024	1280	385
5	S383-11025	1280	382
6	S383-22017	900	403
7	S383-22018	900	403
8	S383-33009	477	382
9	S383-33010	476	380
10	S383-33012	374	382
11	S383-33013	373	380
12	S383-5004	475	350
13	S383-99507	1307	395
14	S383-99530	1307	498

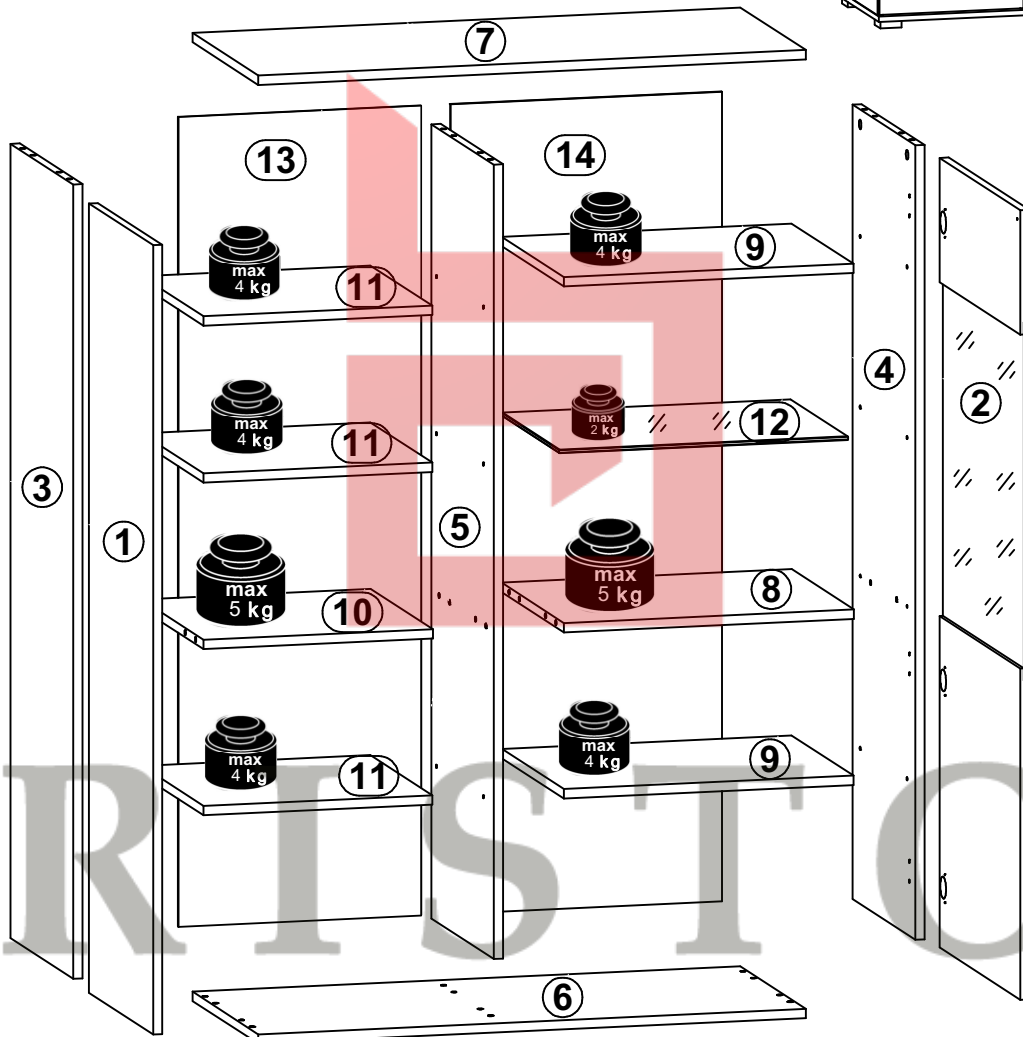
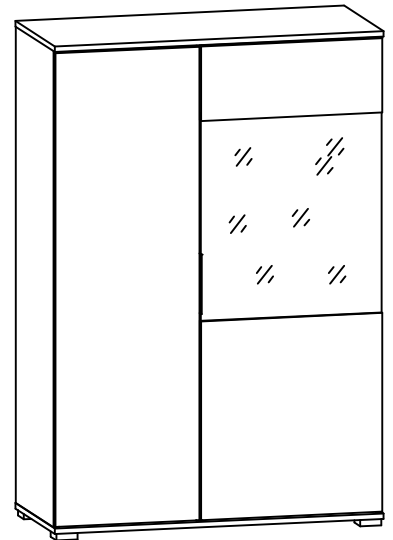
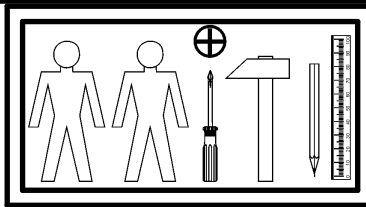

6x a44	6x b19	1x c409 128mm	20x d1 Ø5x17 mm	4x d3 Ø5x17 mm	6x e1 Ø7x50 mm	10x e3 Ø6x13 mm	20x f1 Ø8x30 mm	5x k82\1
5x k82\2	65x l1	4x o21 silikon	12x p51 Ø3,5x15 mm	2x p93 Ø4x13 mm	14x r1 Ø15x12 mm #16	2x r10	10x r42 20x11	1x z28\1
1x z28\2 82x9,5x5,5mm	1x z28\3 20x20x1,5 mm	3x z28\4 Ø3x12mm	6x s2 Ø16	1x z1 4 mm	7x n108 20x13x3,5x1	7x p55 Ø2,9x16 mm		
							1 n26\1	1x p38 Ø3,5x16 mm

# 1

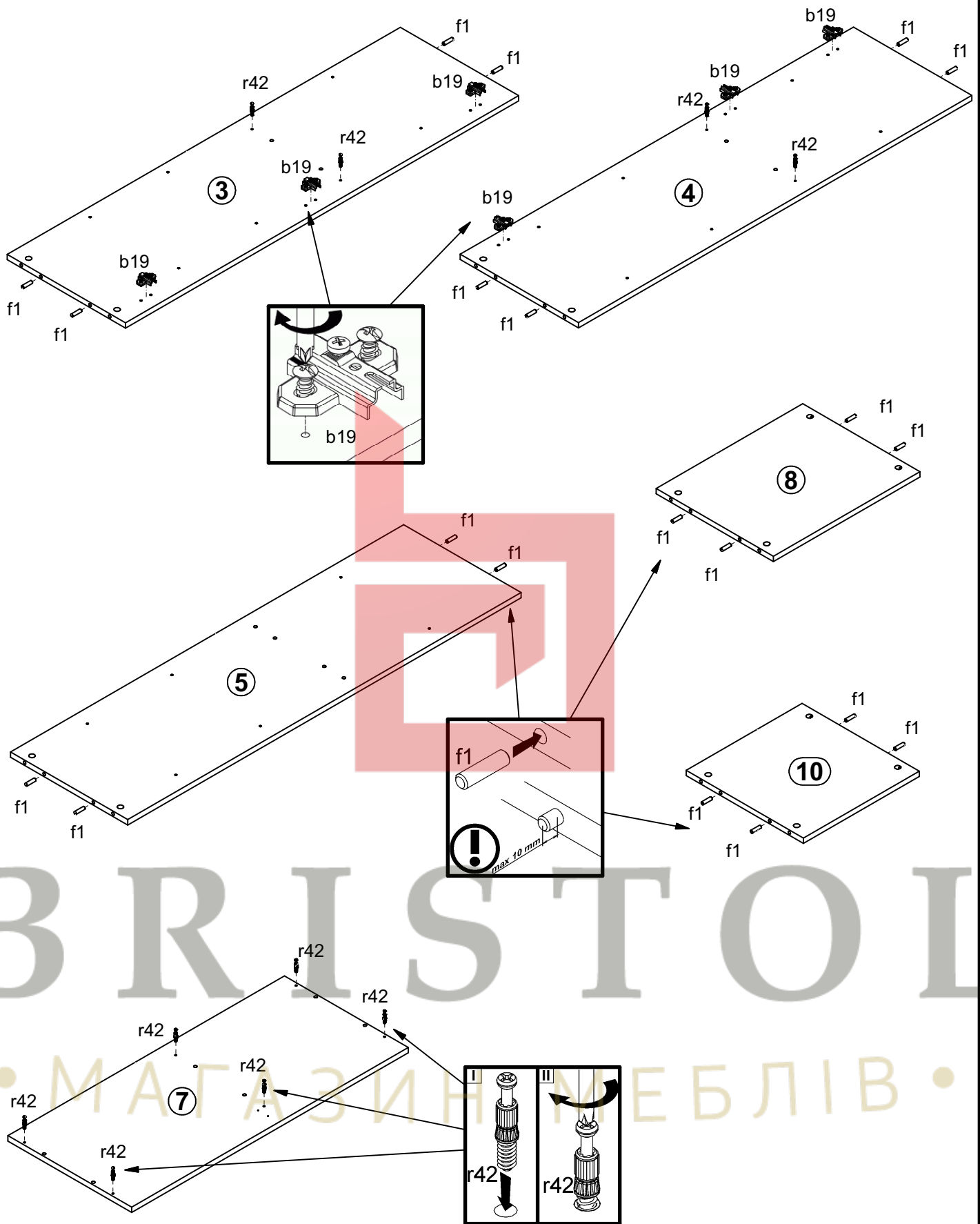

# 2

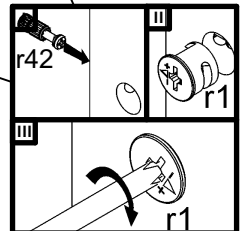
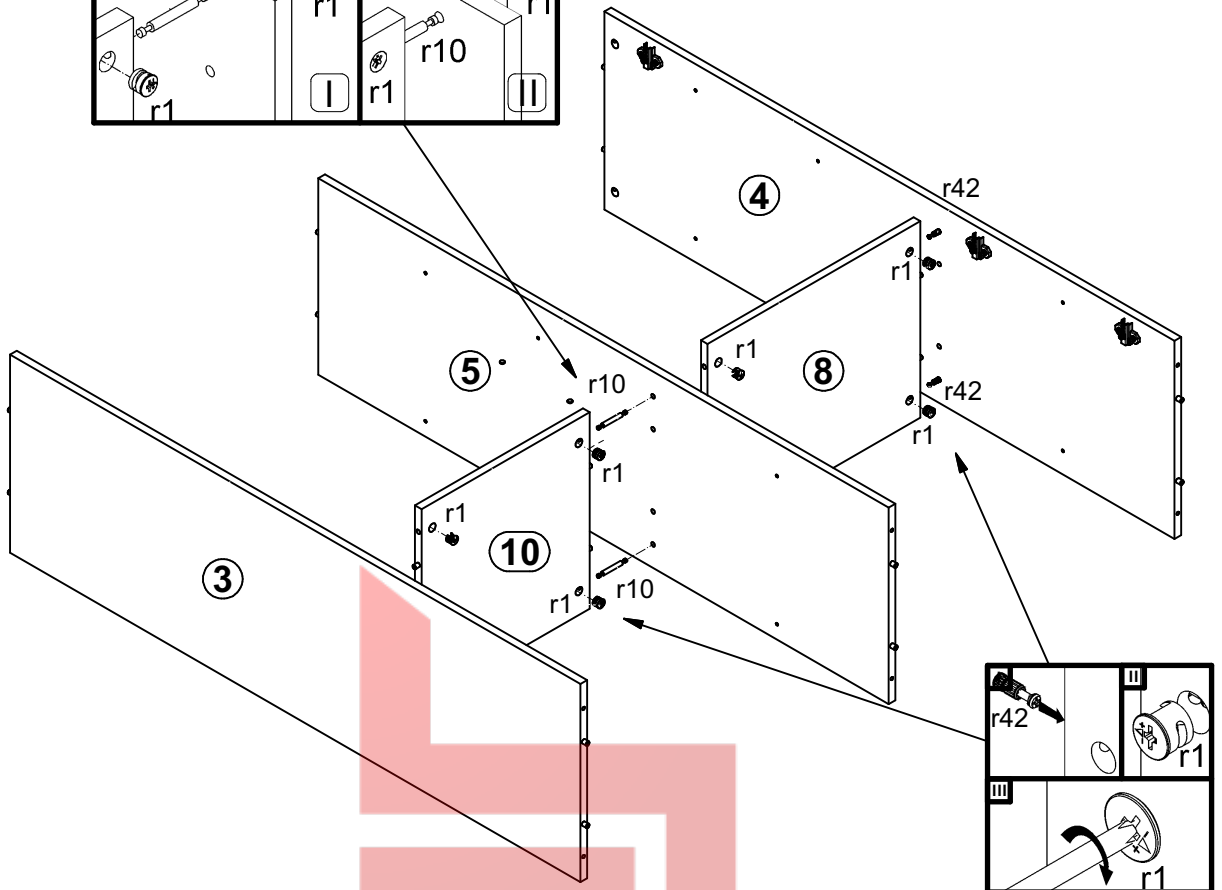
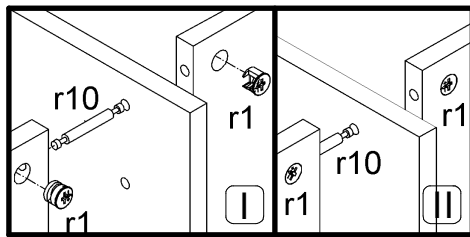

# 3

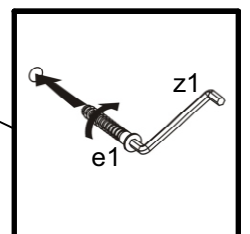
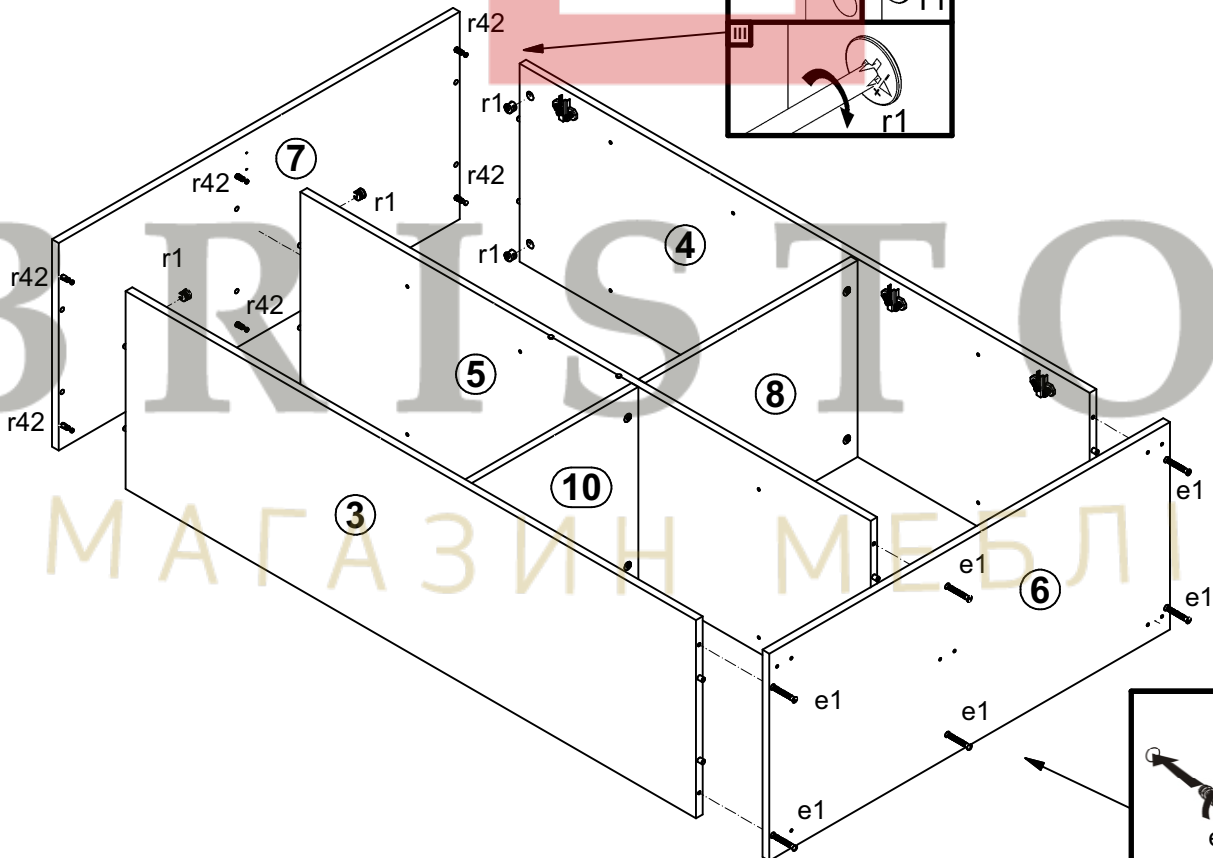
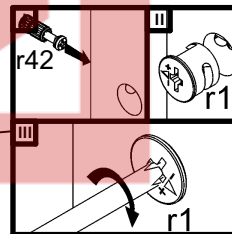

# 4

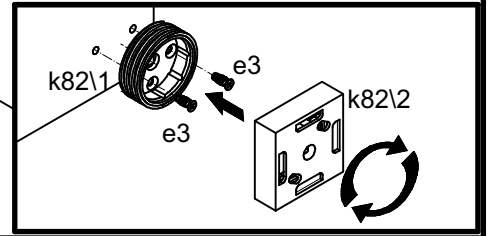
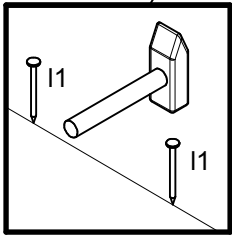
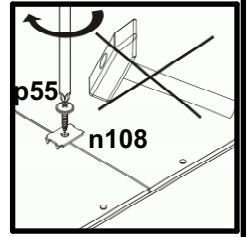
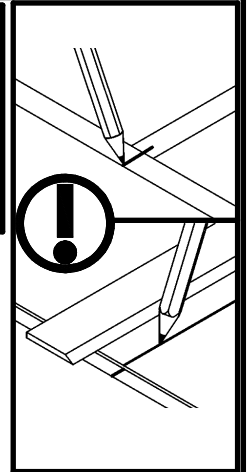
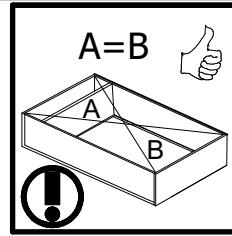
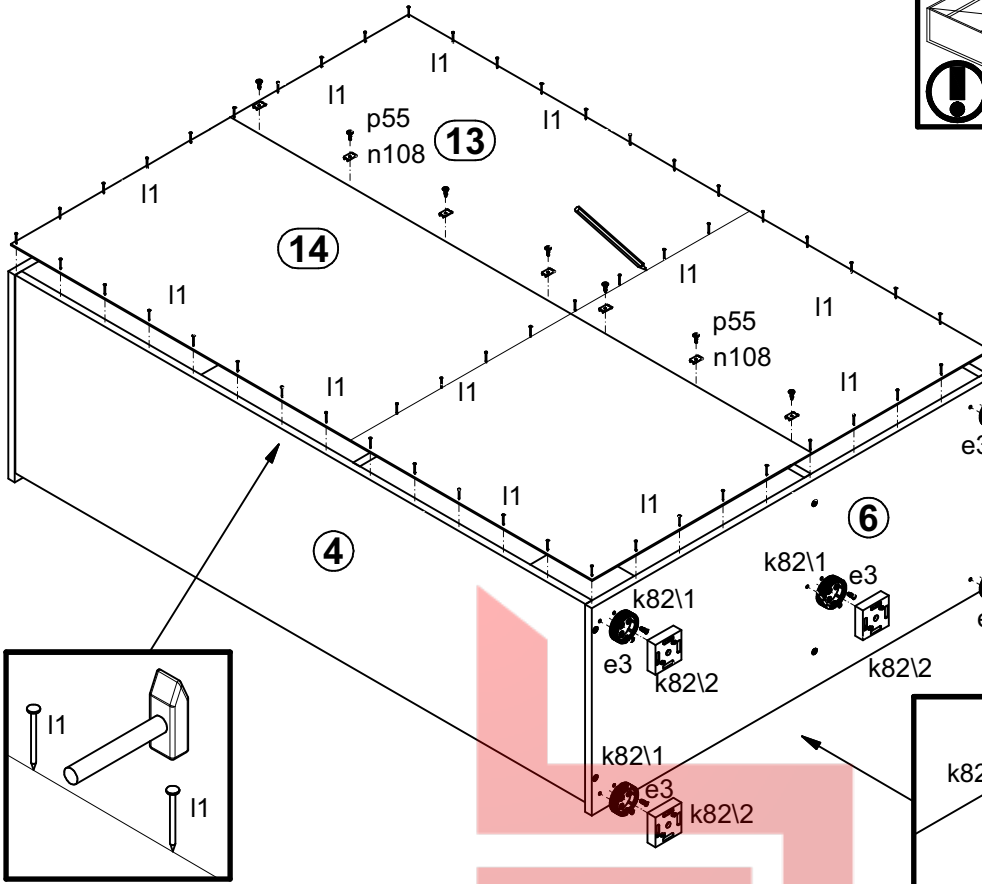

# 5

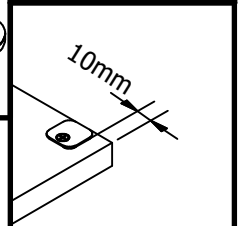
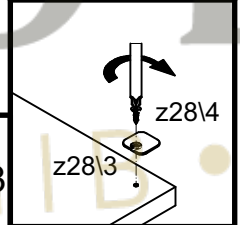
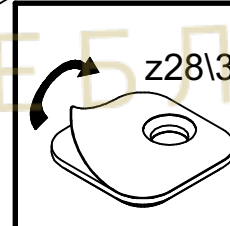
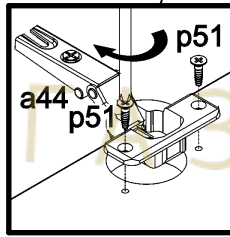
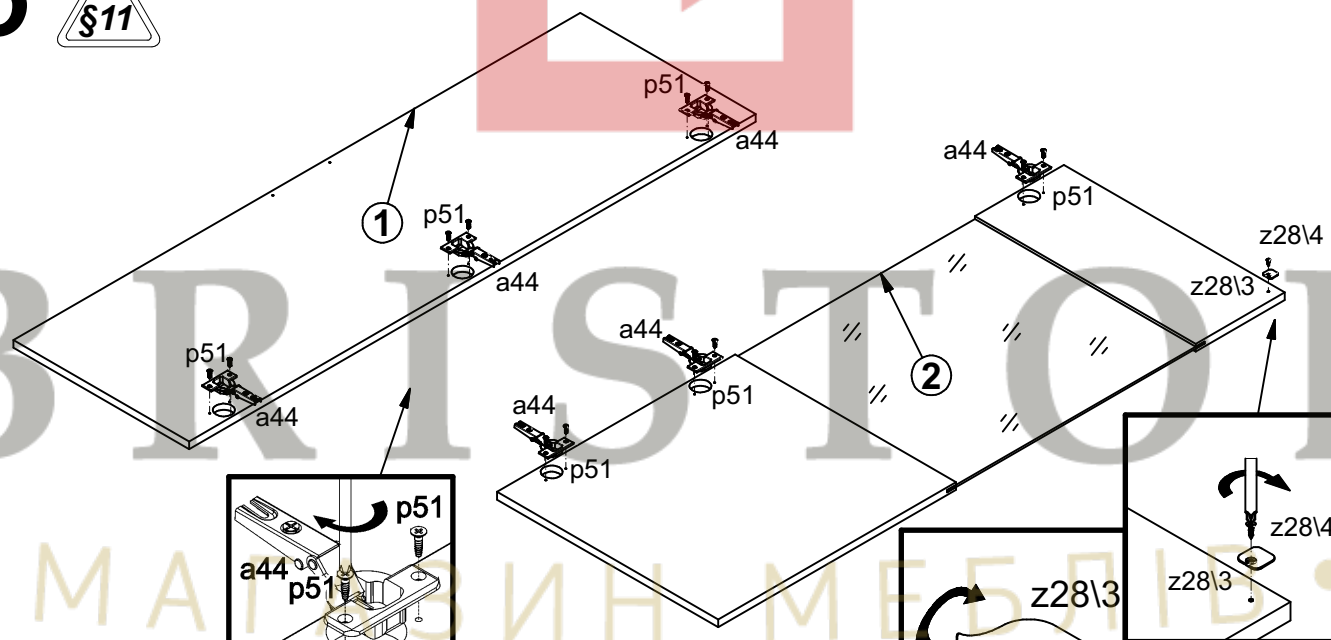

# 6

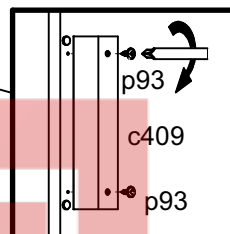
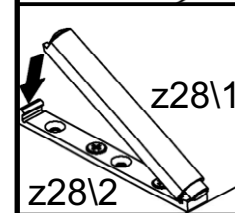
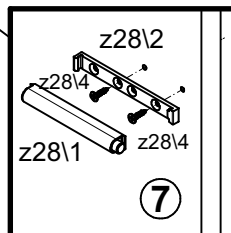
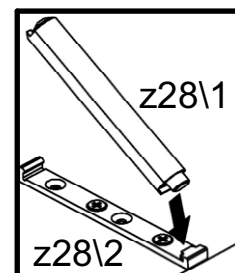
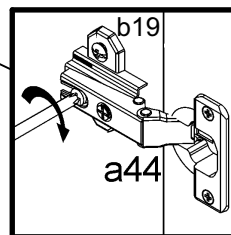
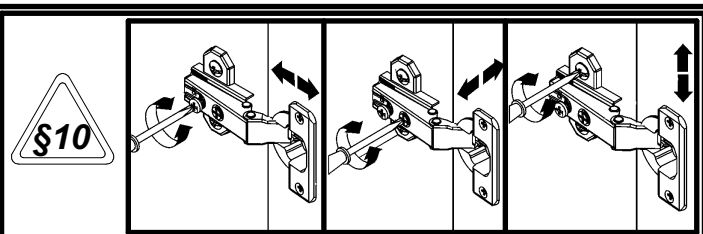
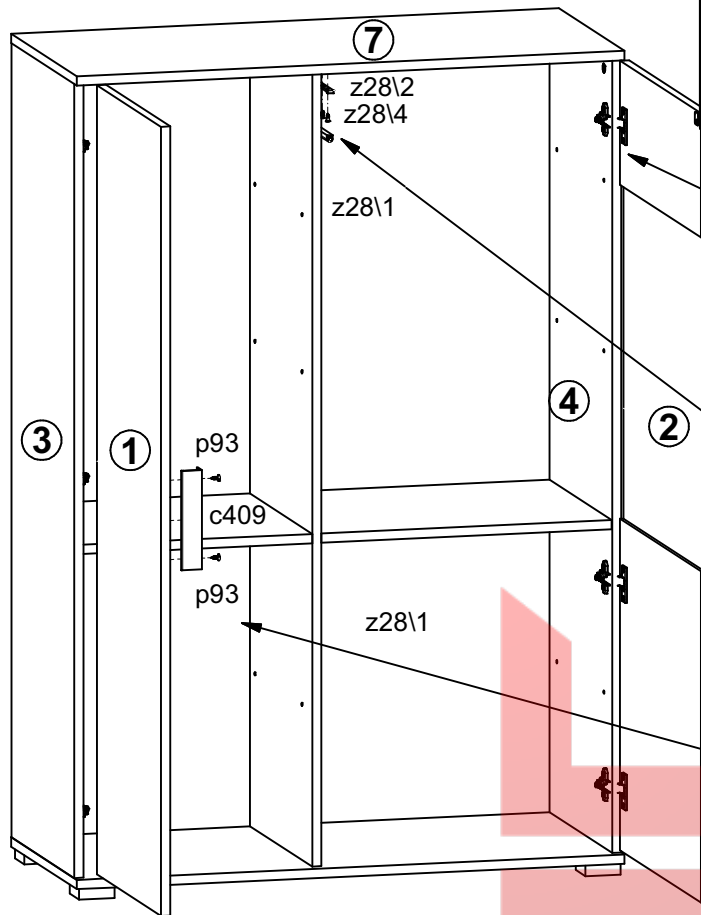

# 7

