

A	B	C	D	A	B	C	D		
1	S359-102	396	479	1/2	5	S359-7104	316	319	1/2
2	S359-201	1200	600	1/2	6	S359-5048	316	80	2/2
3	S359-202	1084	480	1/2	7	S359-5049	479	80	2/2
4	S359-403	1002	80	1/2	8	S359-5050	316	80	2/2

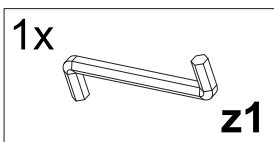

1  §2

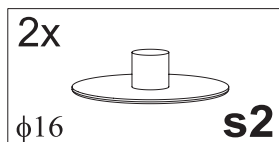
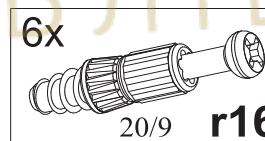
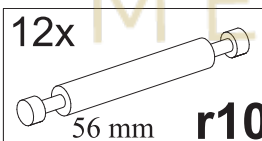
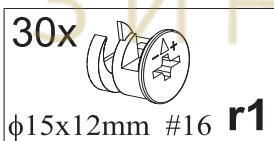
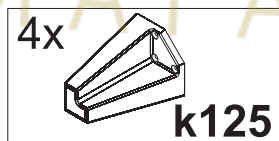
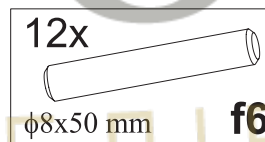
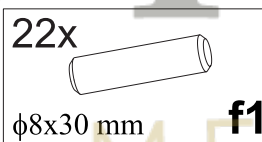
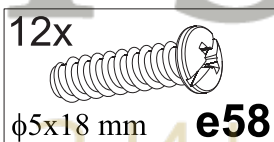
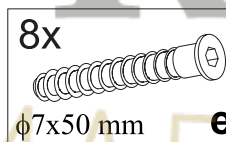
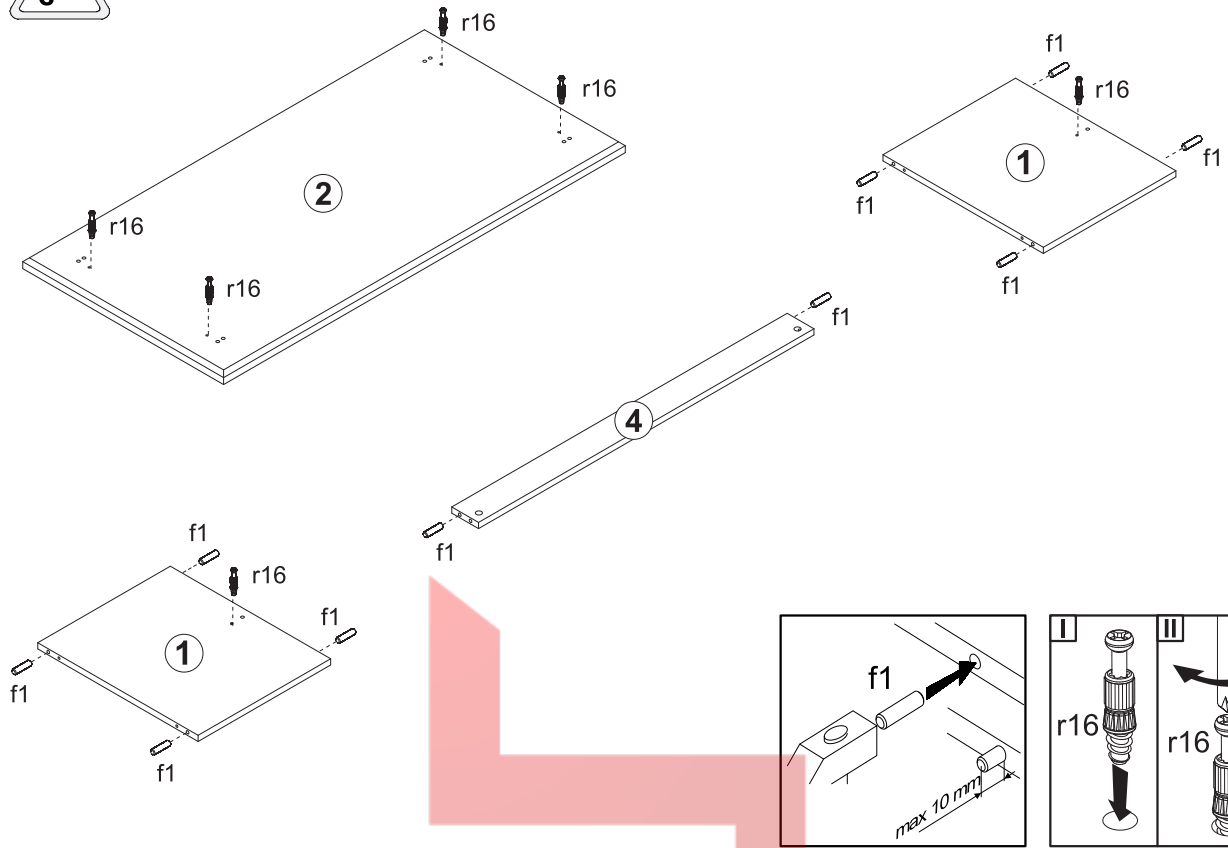

2  §6

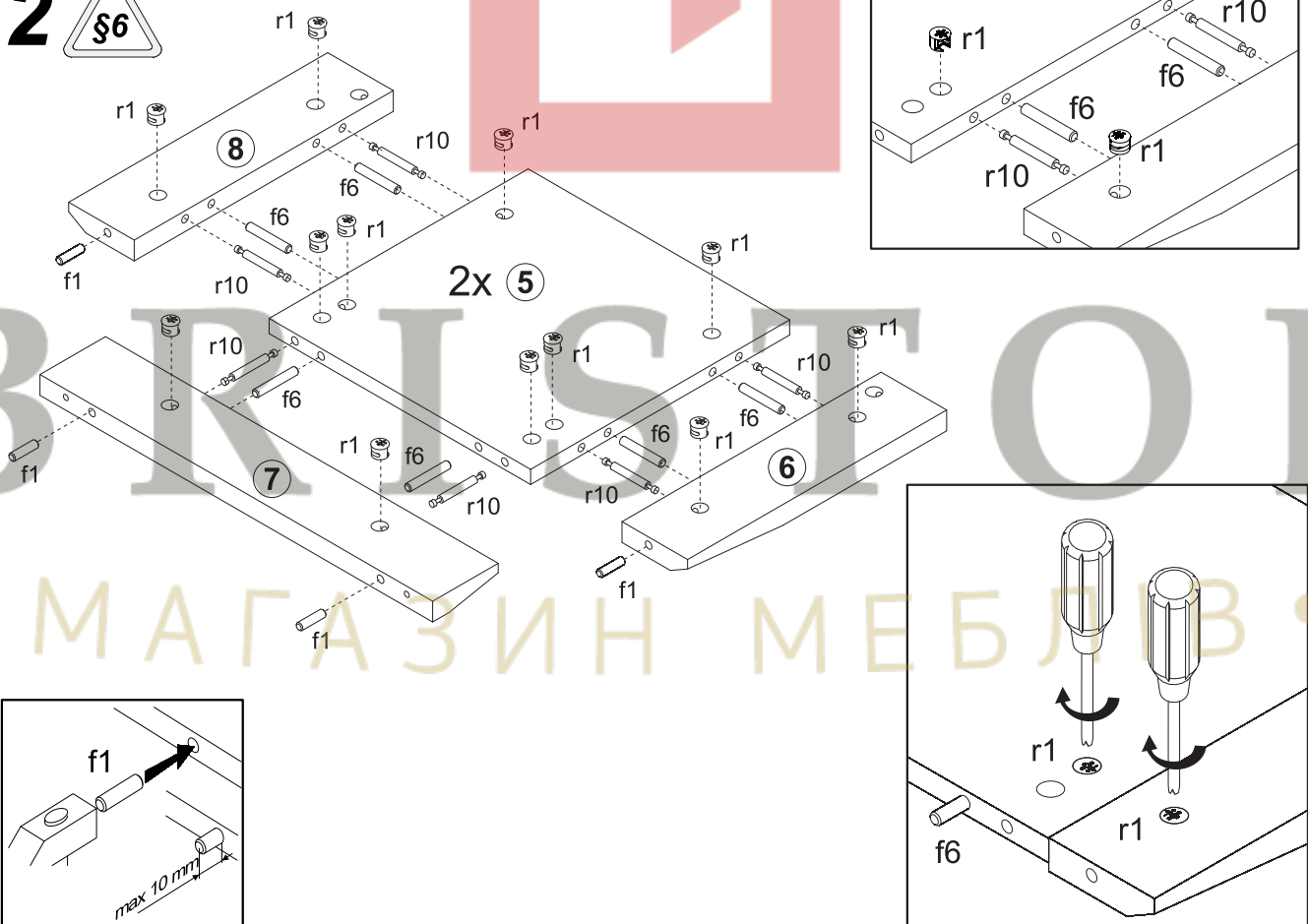

3

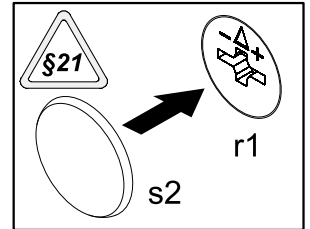
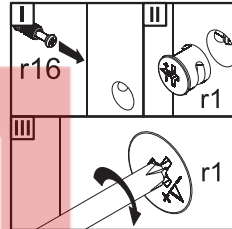
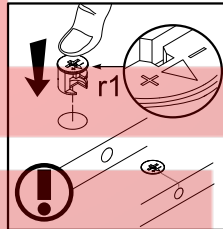
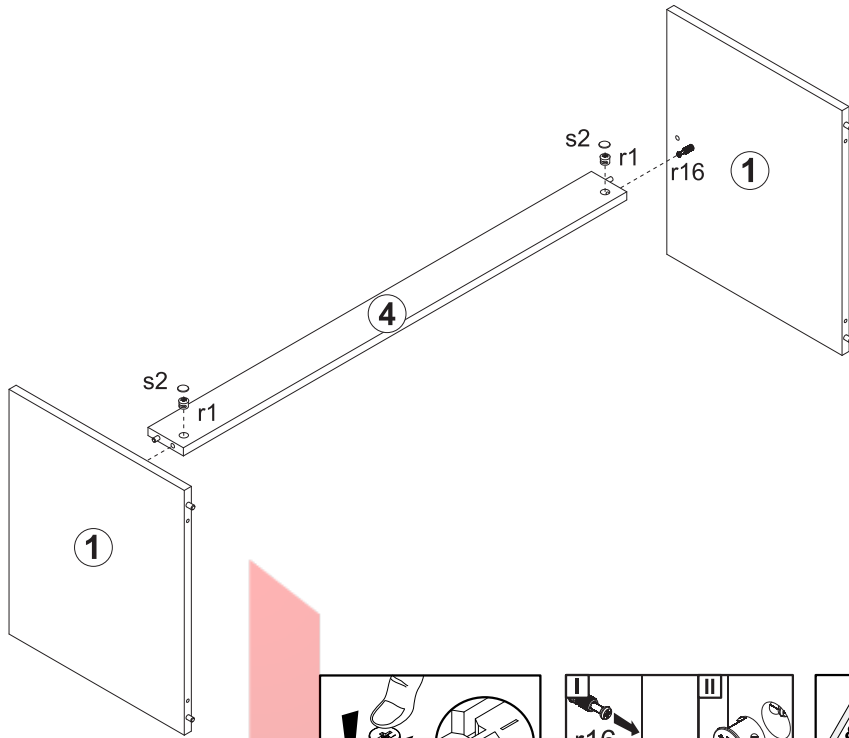

4

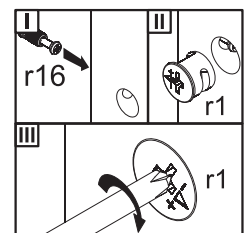
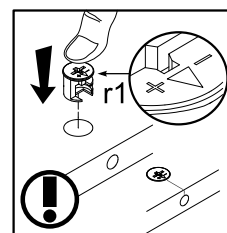
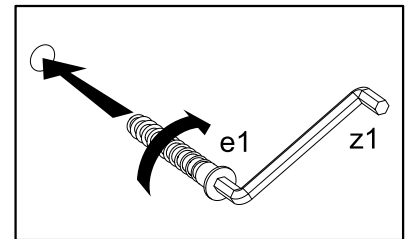
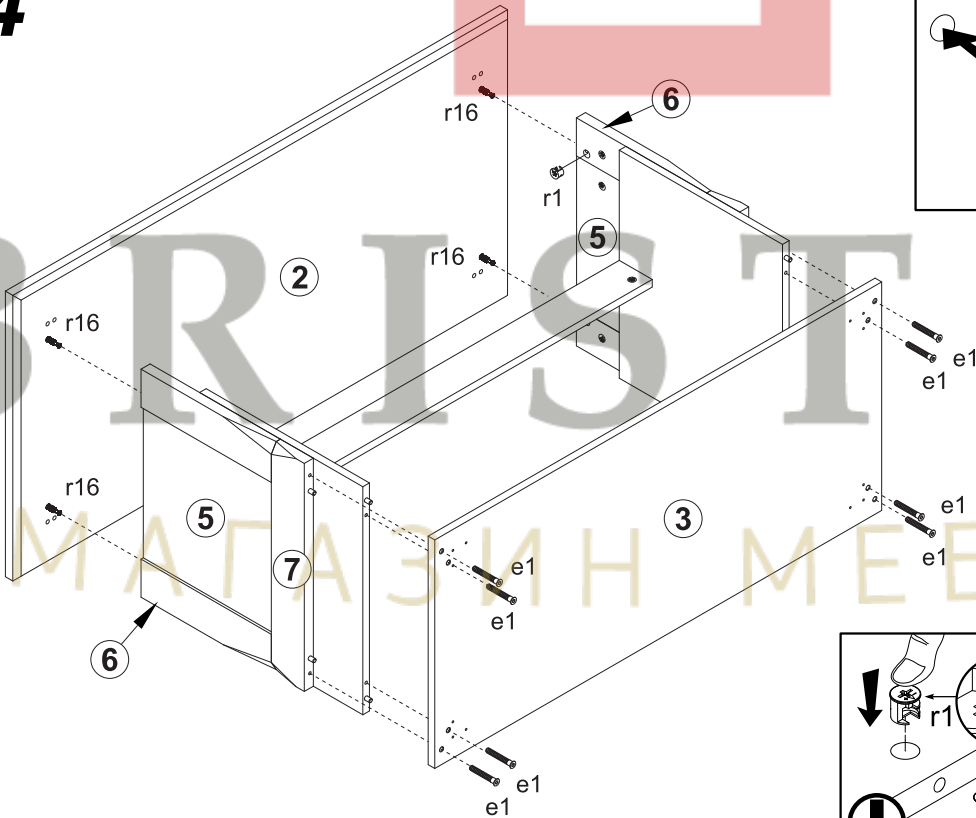

5

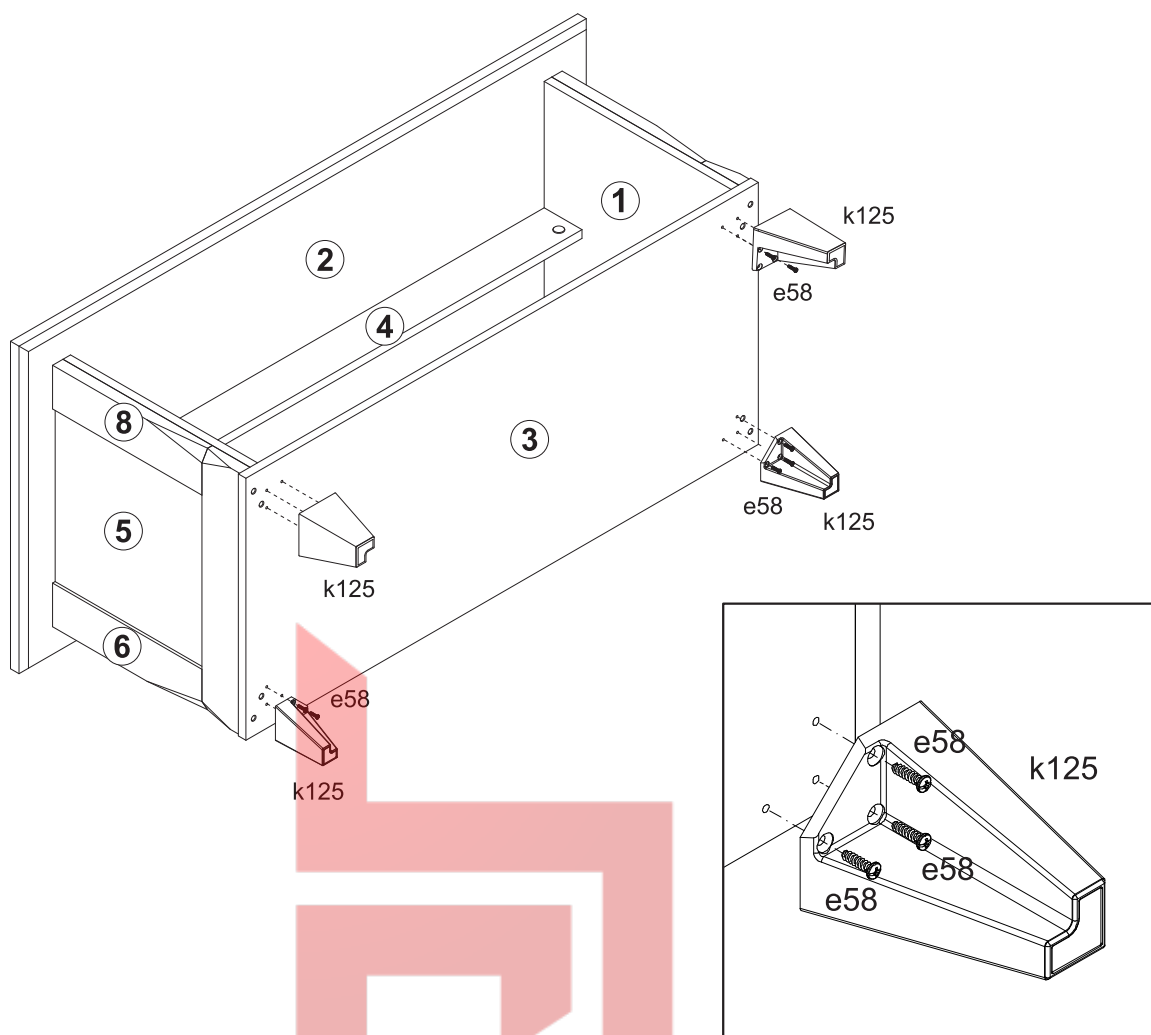

6

