

A	B	C	D
1	S239-0003	2190	480
2	S239-1003	2196	552
3	S239-1004	2196	552
4	S239-2013	968	595
5	S239-2014	968	581

A	B	C	D
6	S239-3005	934	552
7	S239-4002	934	160
8	S239-9004	2245	480
9	LH-2211	2211	14
10	DR-929	929	

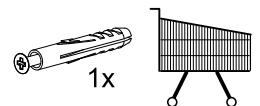

1

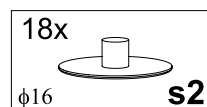
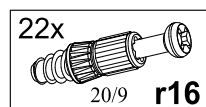
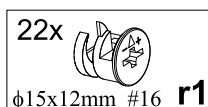
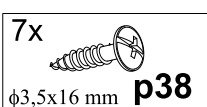
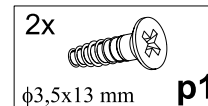
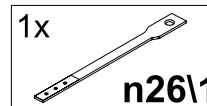
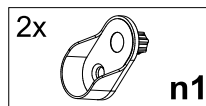
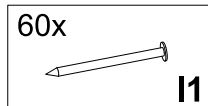
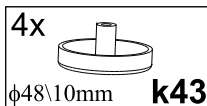
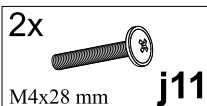
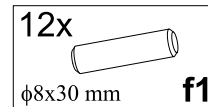
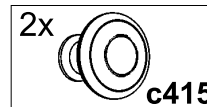
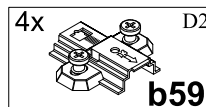
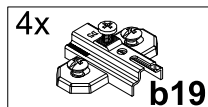
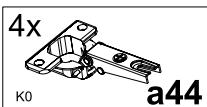
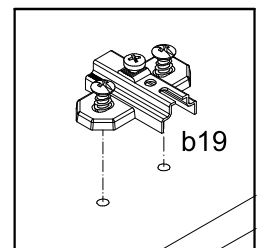
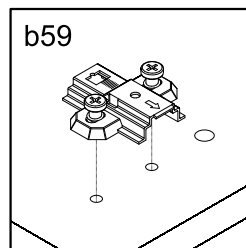
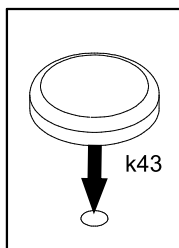
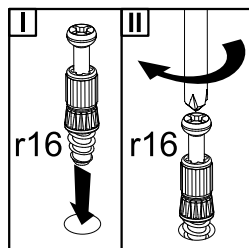
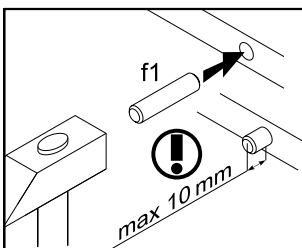
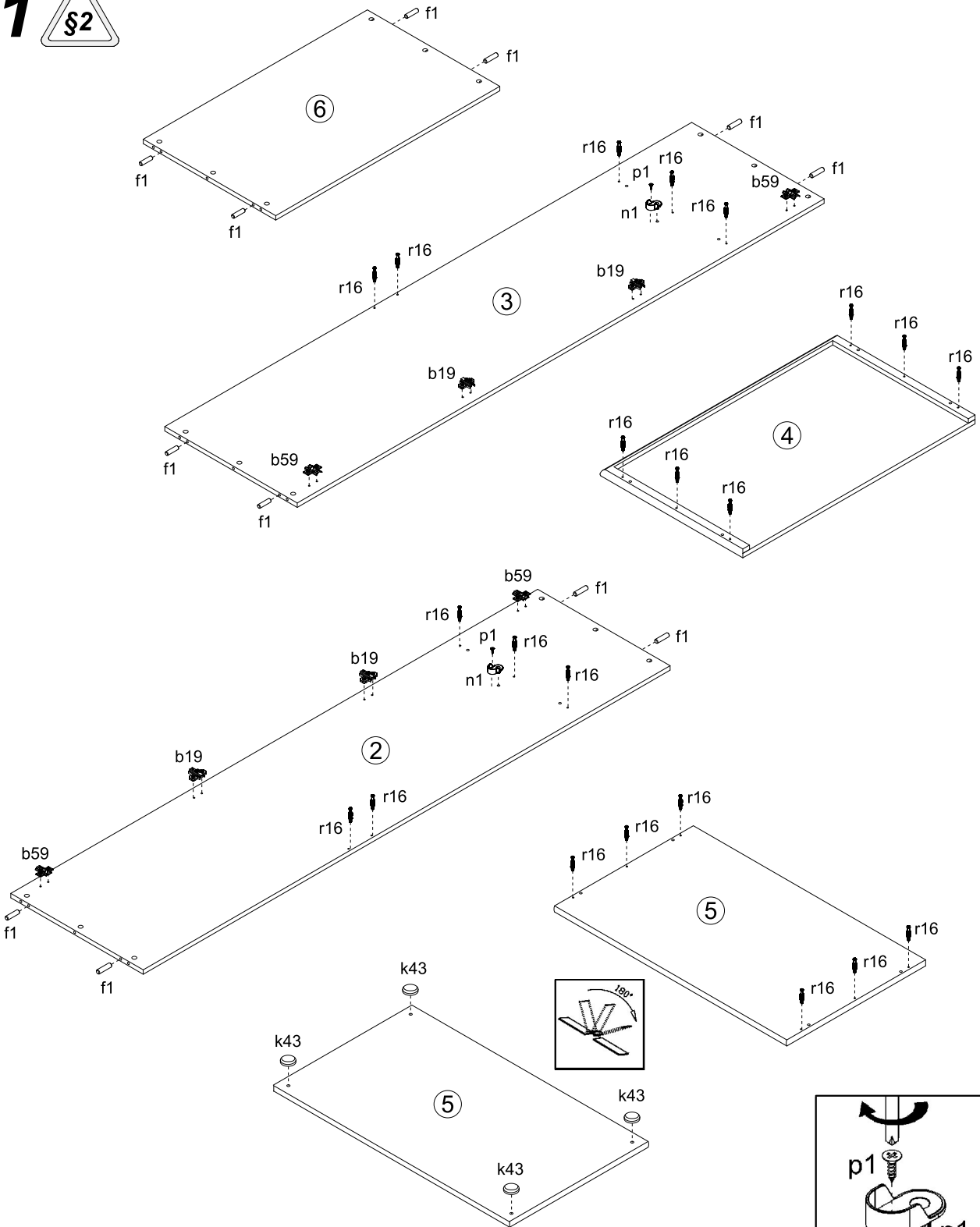

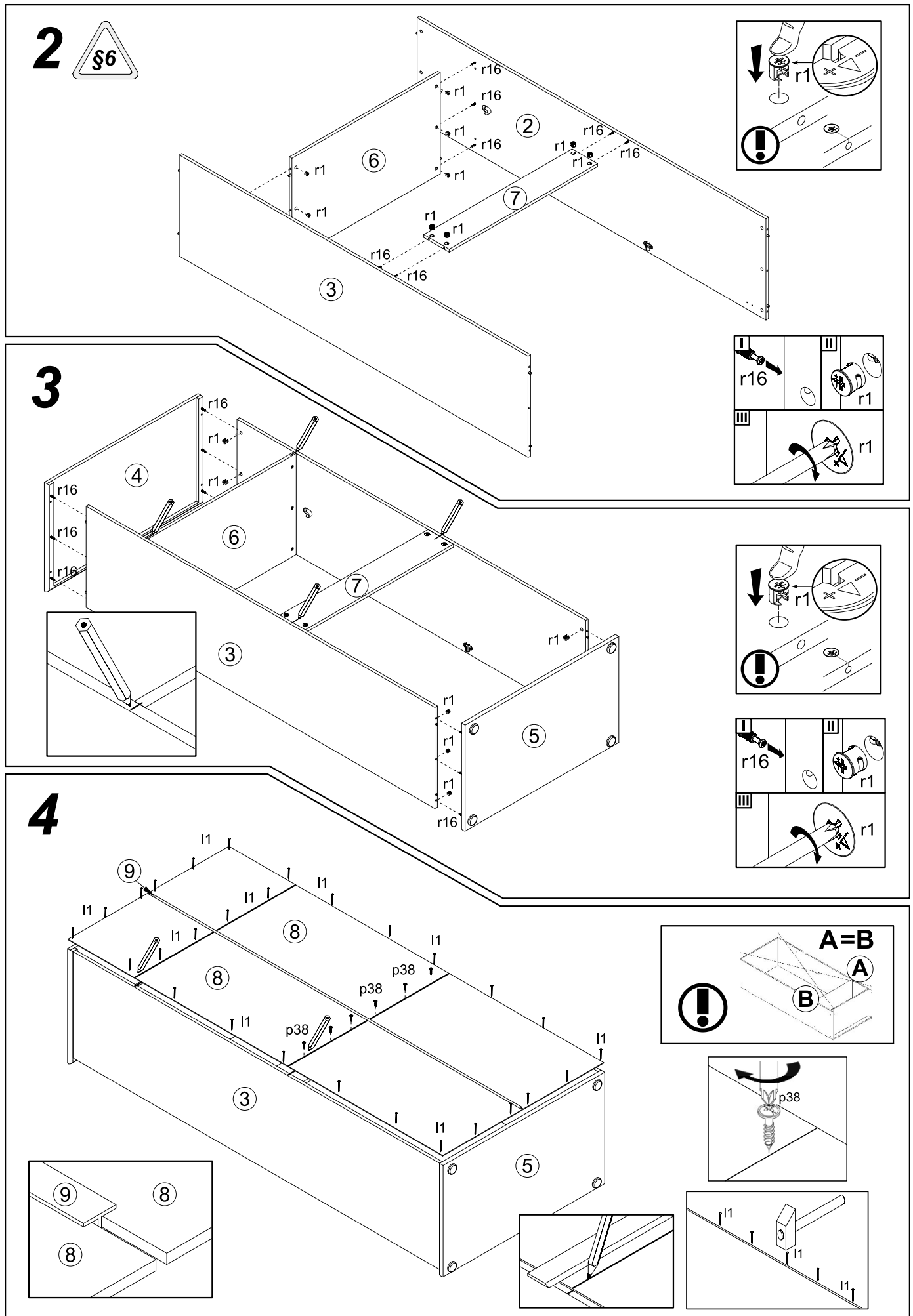

5

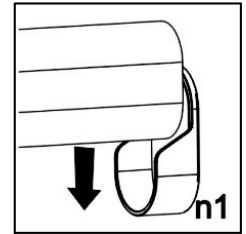
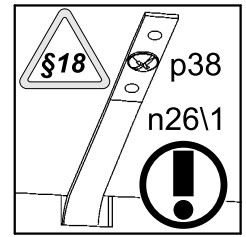
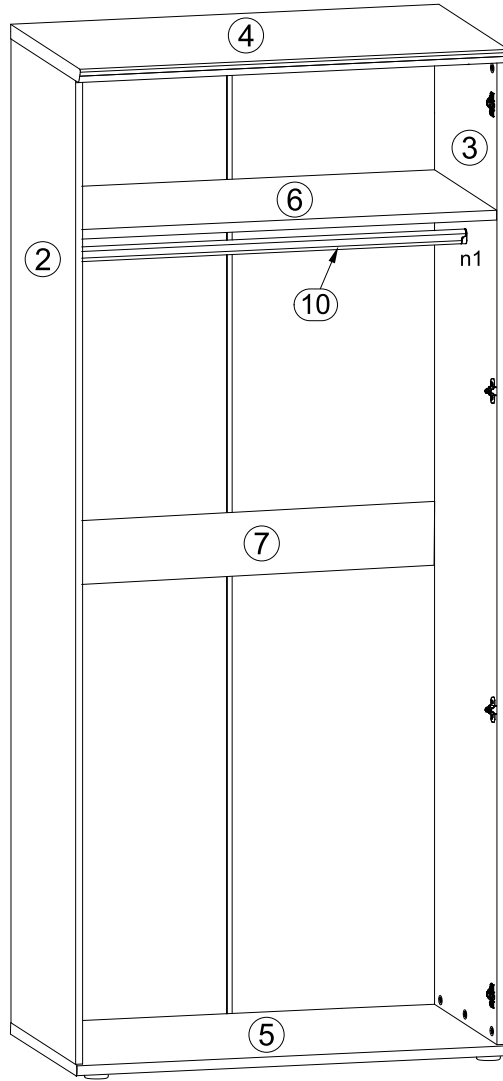

6

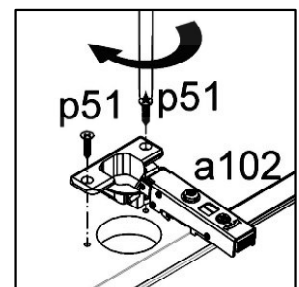
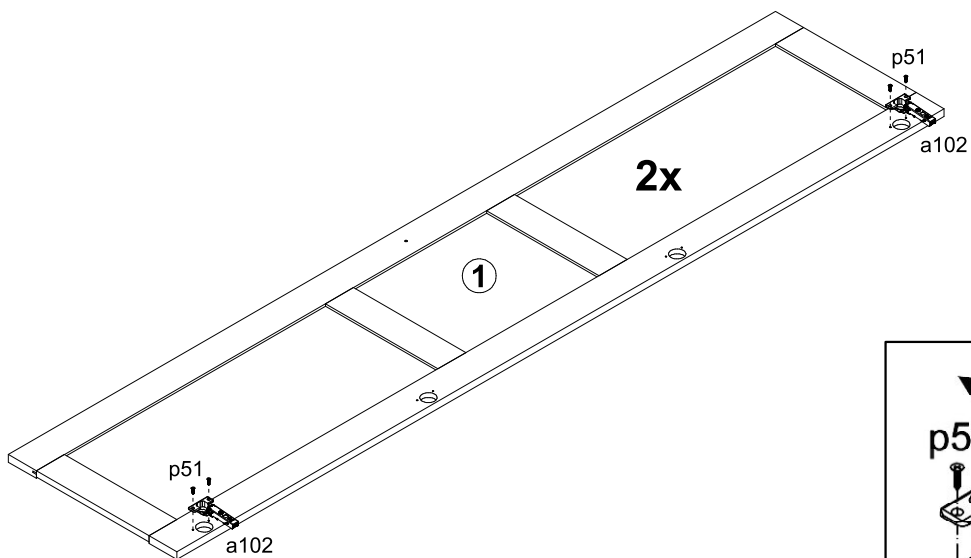

7

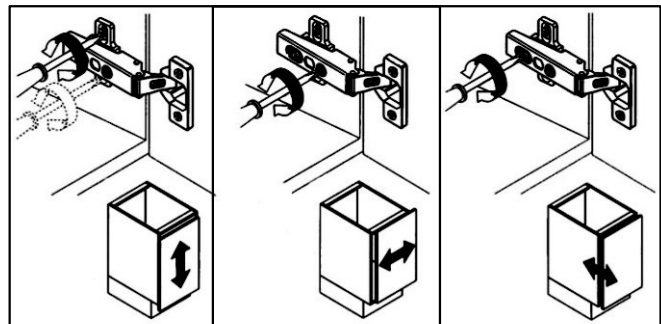
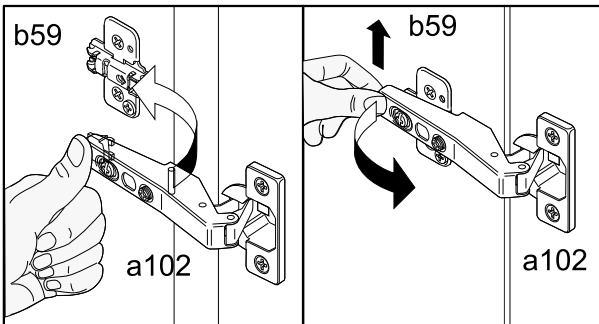
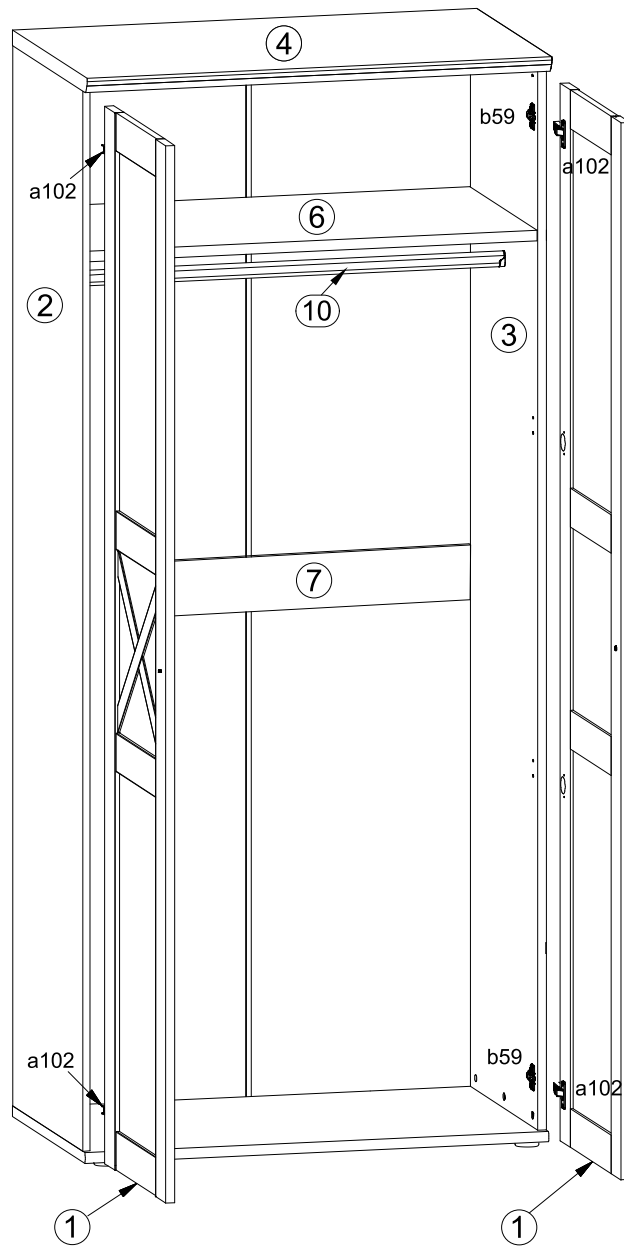

8

