

1	S404-0017	446	205	3/3	14	S404-3009	1457	408	2/3
2	S404-0018	446	205	3/3	15	S404-4006	1350	60	2/3
3	S404-0019	446	180	3/3	16	S404-4007	1350	100	2/3
4	S404-1018	560	428	1/3	17	S404-5005	1349	70	2/3
5	S404-1019	560	428	1/3	18	S404-5006	1349	70	2/3
6	S404-1017	308	392	1/3	19	S404-5101	384	120	1/3
7	S404-1020	308	408	1/3	20	S404-5104	377	120	1/3
8	S404-1021	308	408	1/3	21	S404-5102	366	120	1/3
9	S404-1022	154	408	1/3	22	S404-5103	366	120	1/3
10	S404-5011	560	70	1/3	23	S404-9001	399	365	2/3
11	S404-5012	560	70	1/3	24	S404-9009	392	365	2/3
12	S404-2005	1491	454	2/3	25	S404-9503	167	1468	2/3
13	S404-3008	1457	428	2/3	26	S404-9504	321	1468	2/3

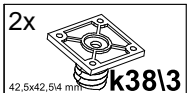

1 §2

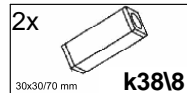
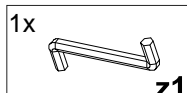
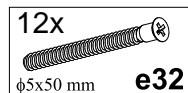
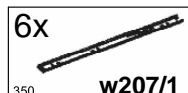
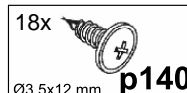
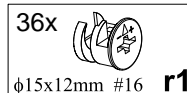
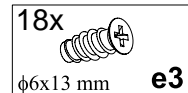
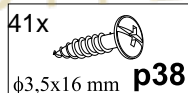
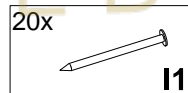
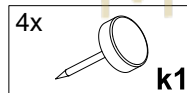
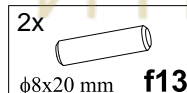
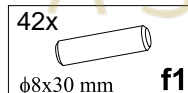
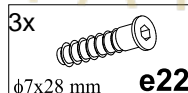
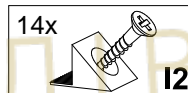
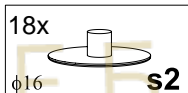
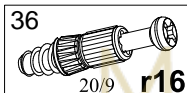
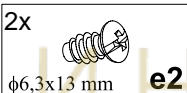
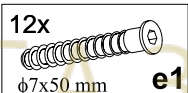
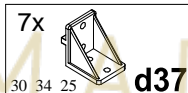
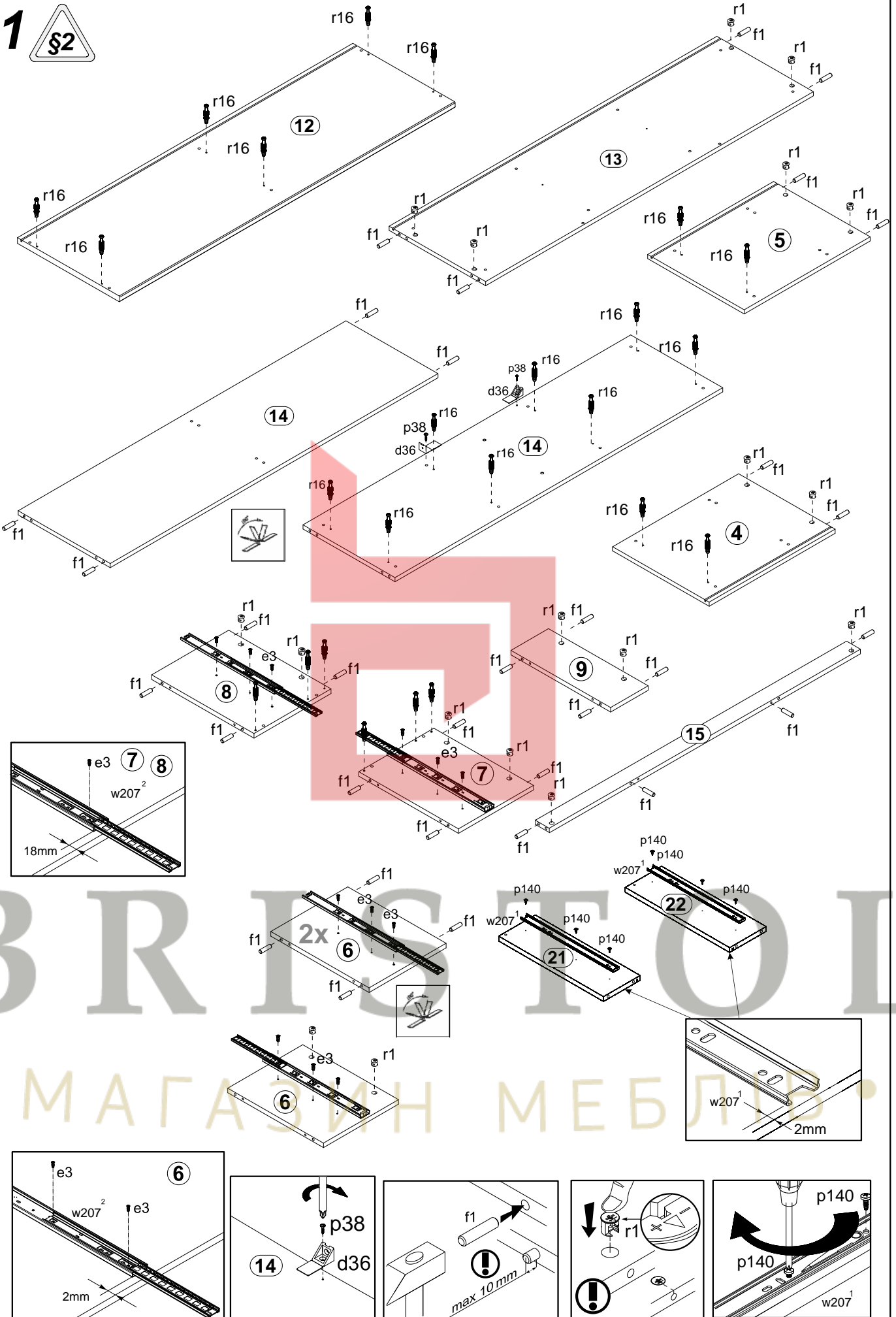

# 2

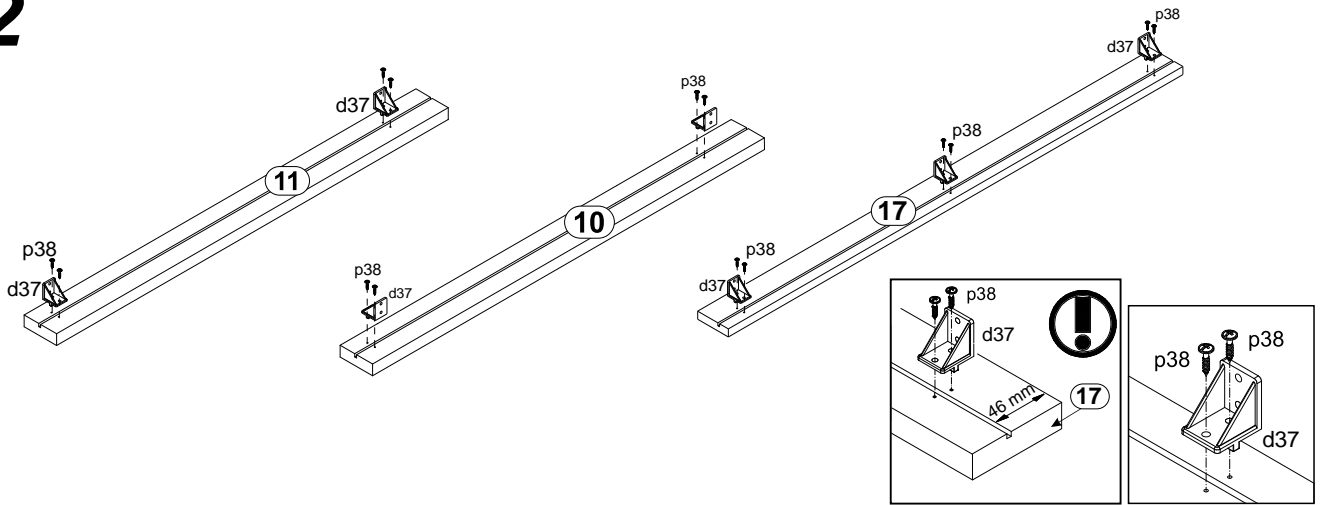

# 3

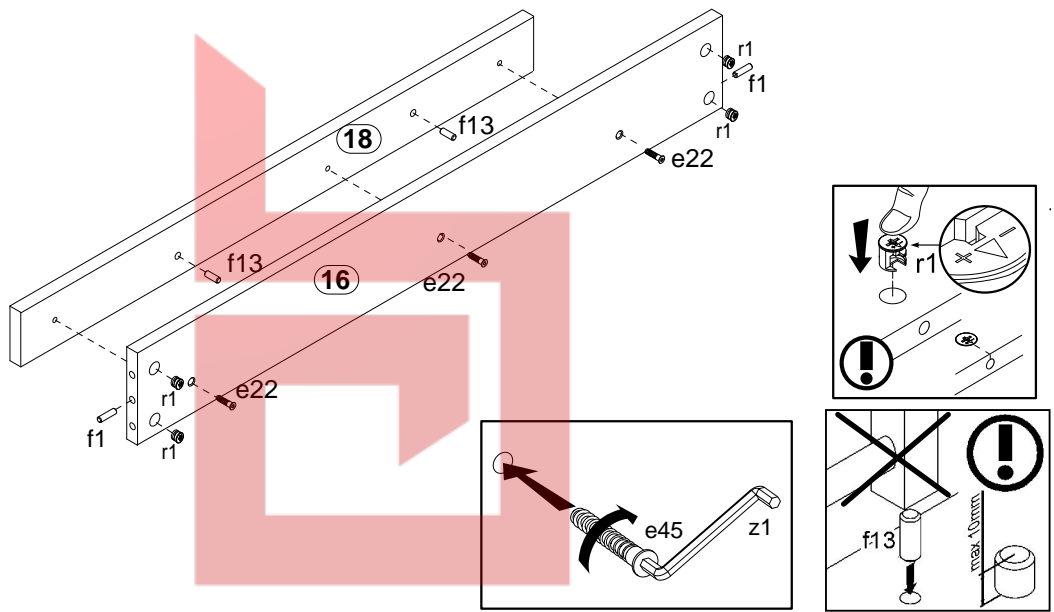

# 4

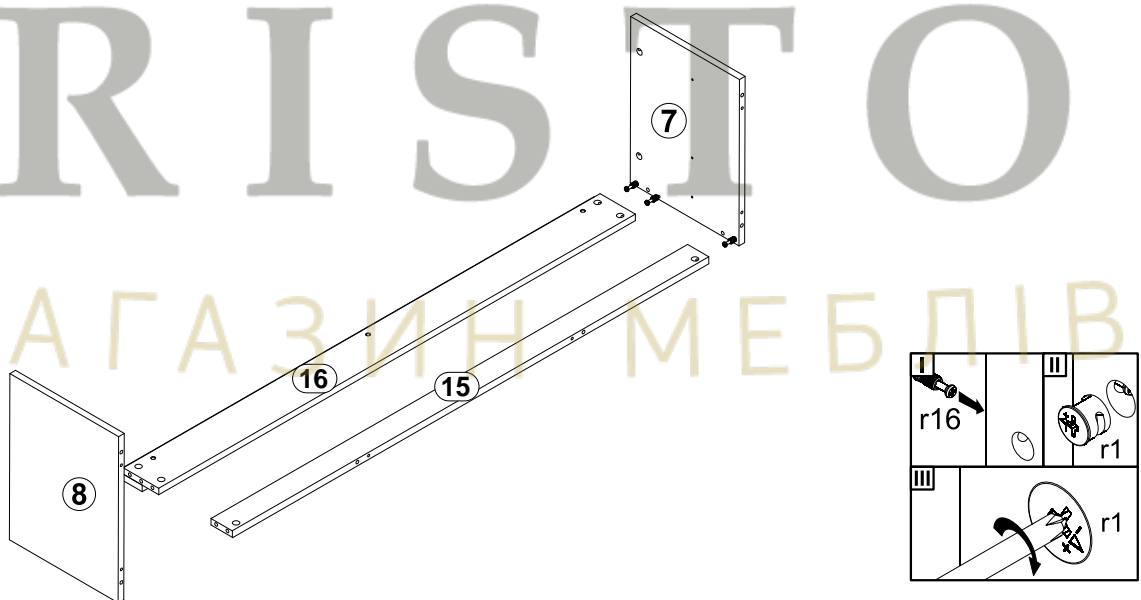

5

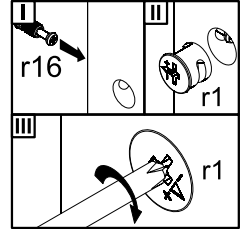
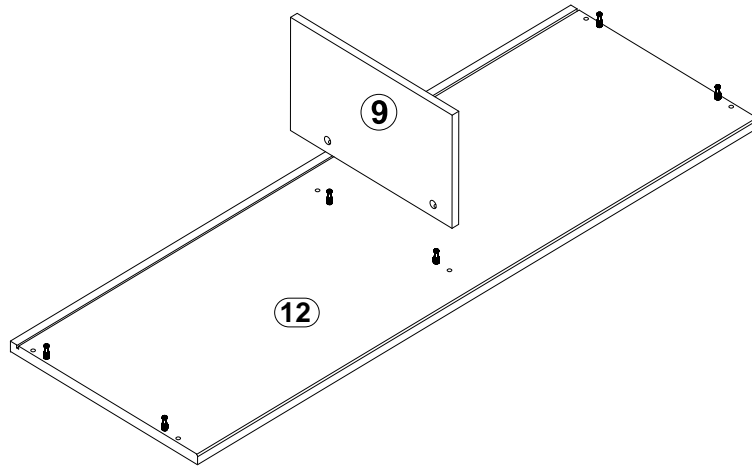

6

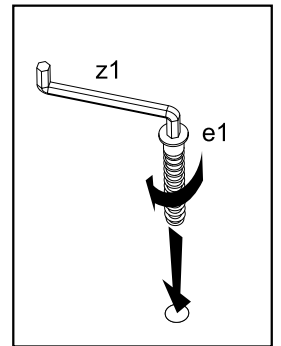
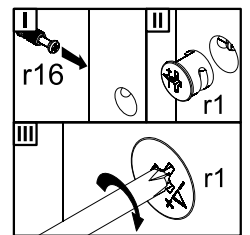
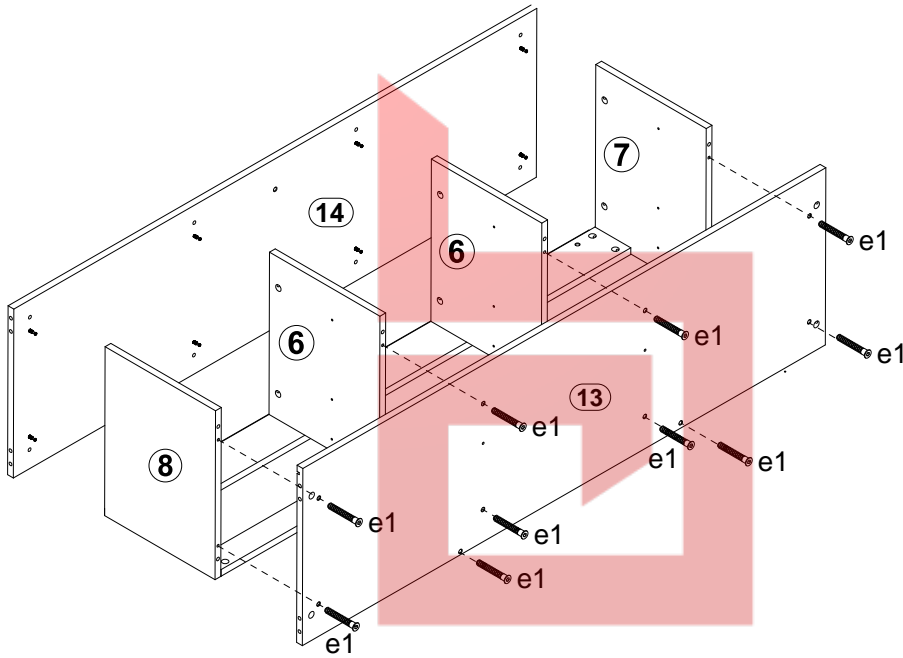

7

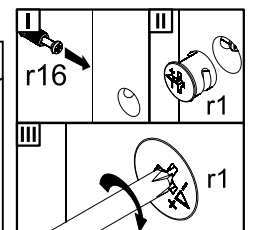
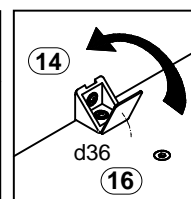
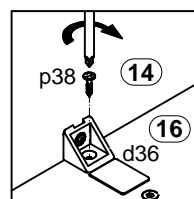
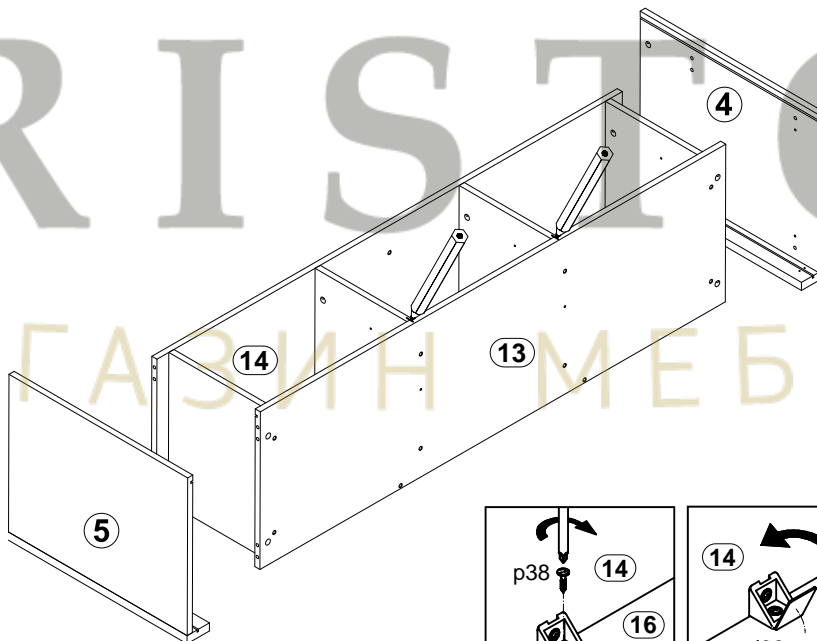

# 8

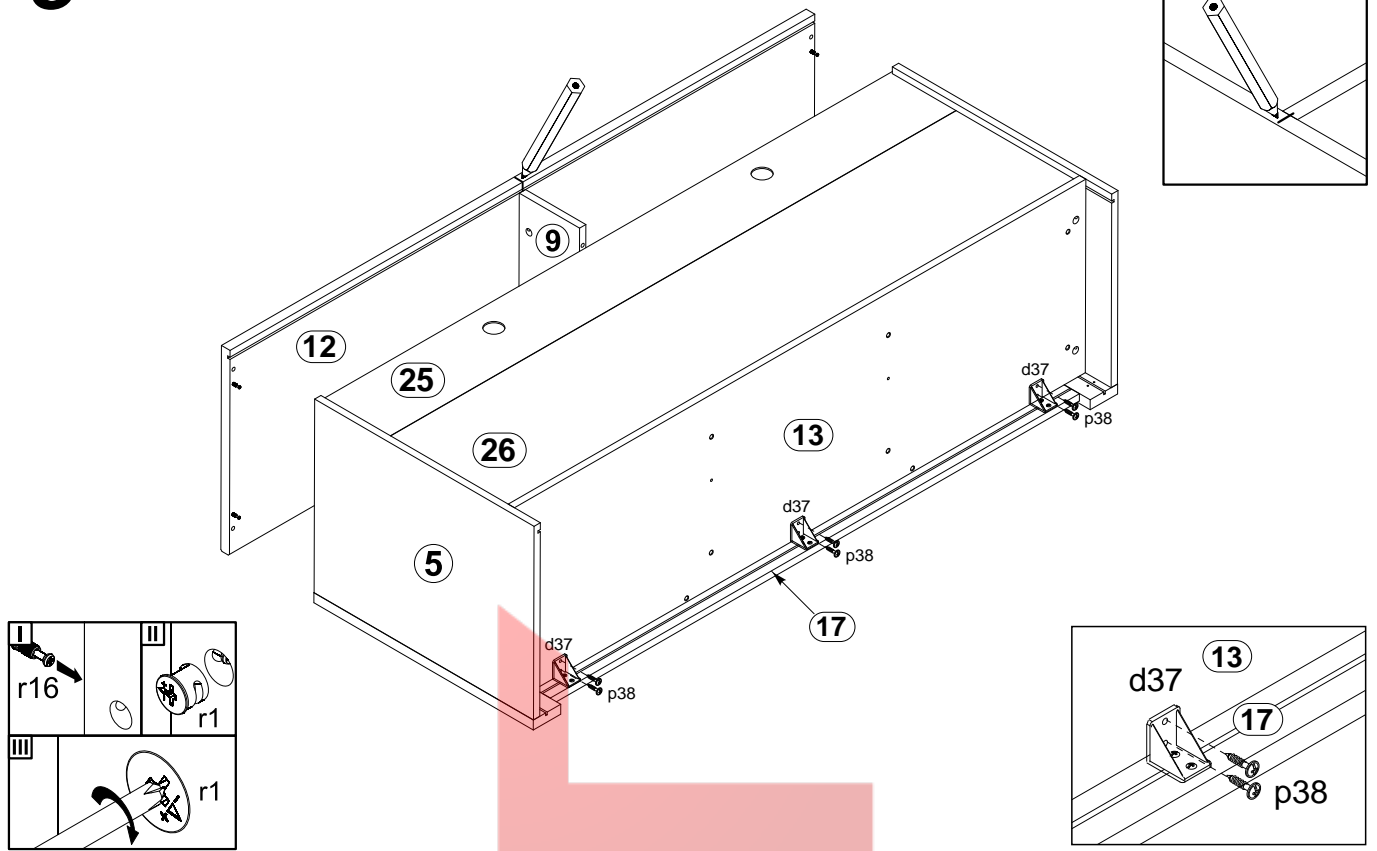

# 9

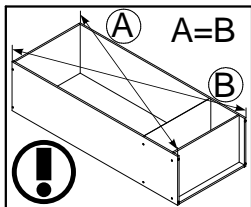
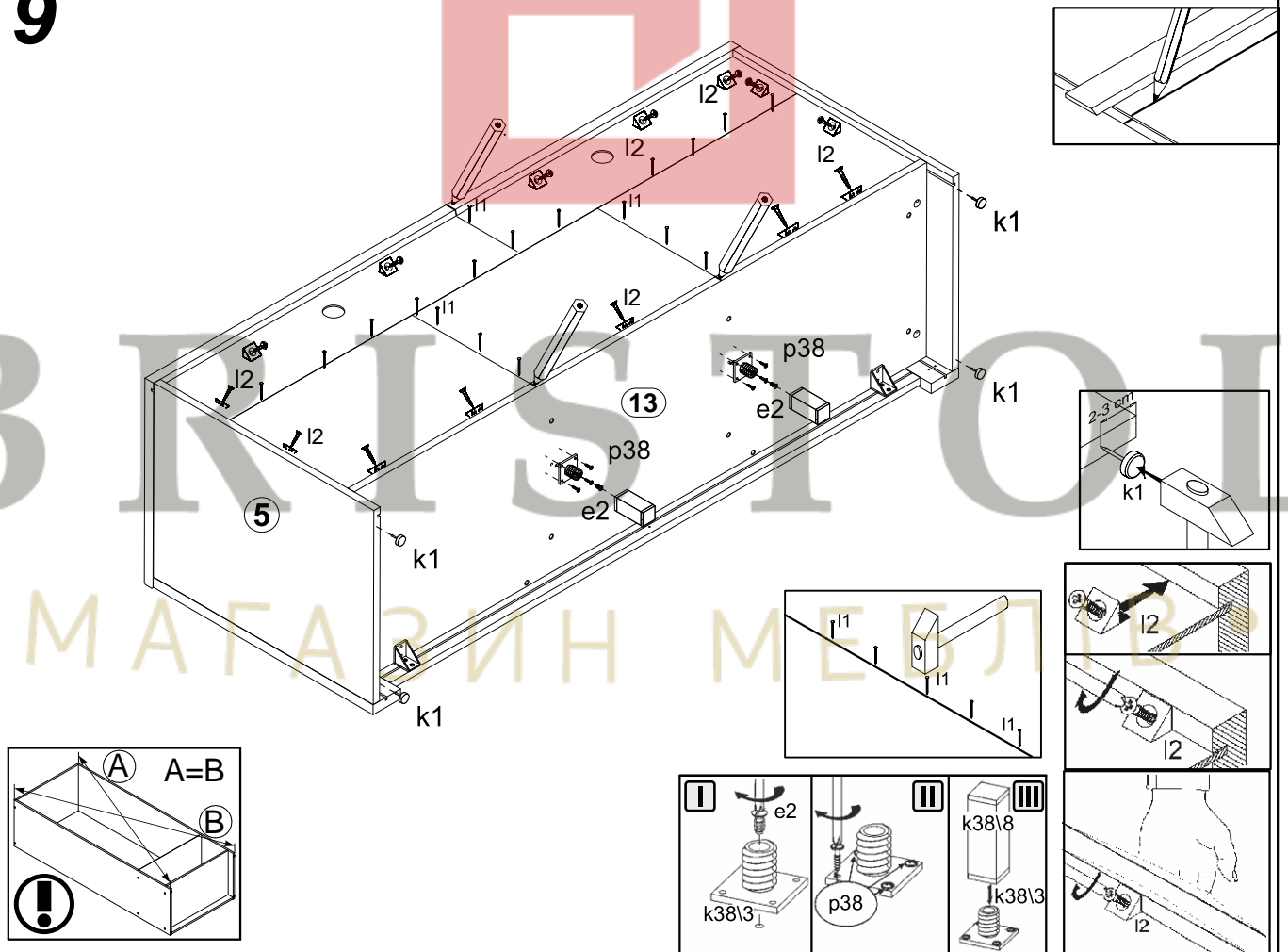

# 10

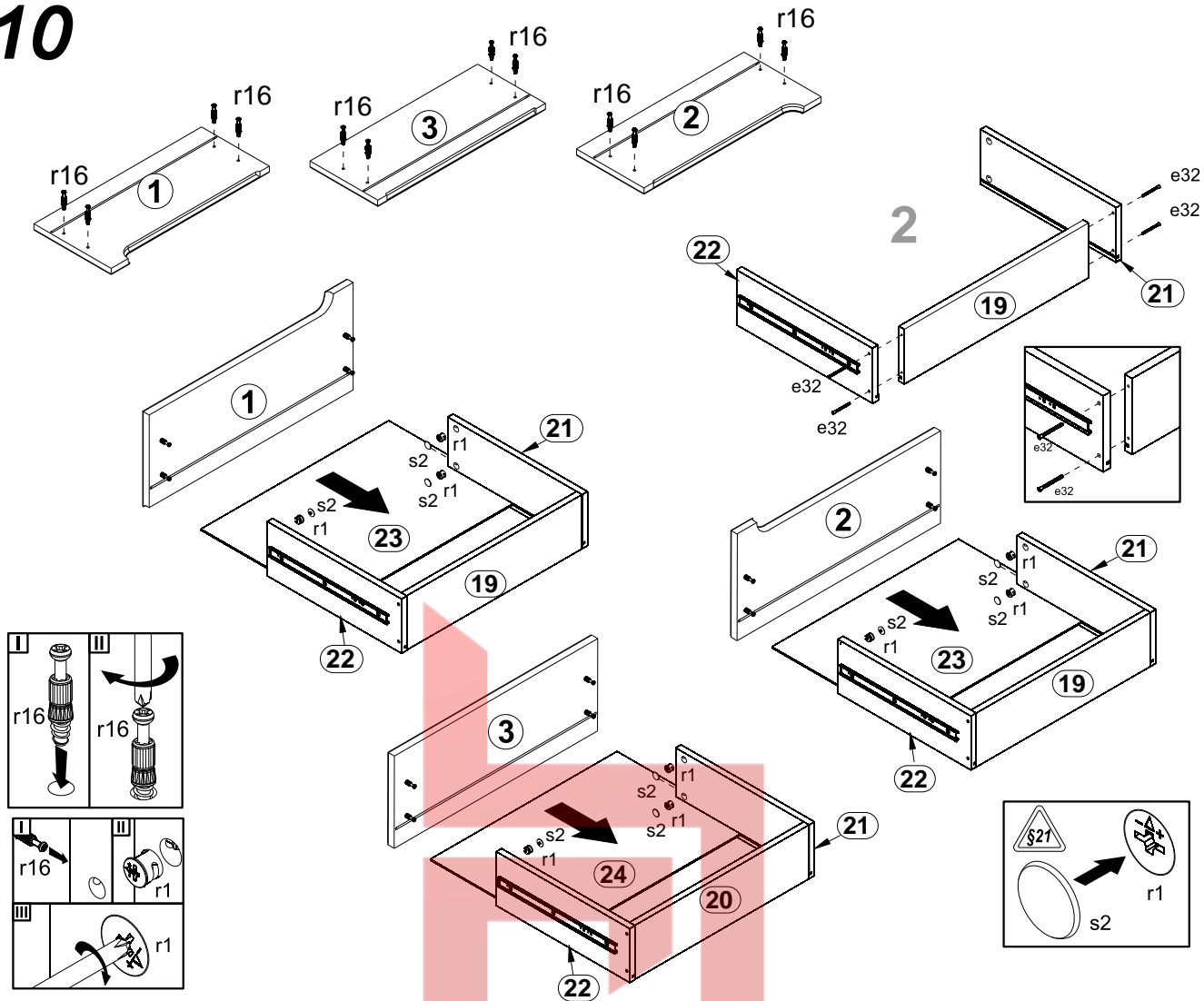

# 11

