

/

/ Erika

/

/ Mirror LUS60

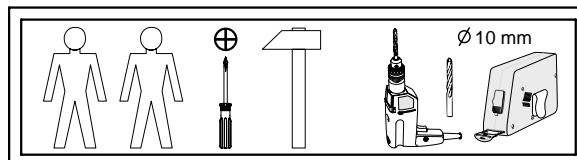
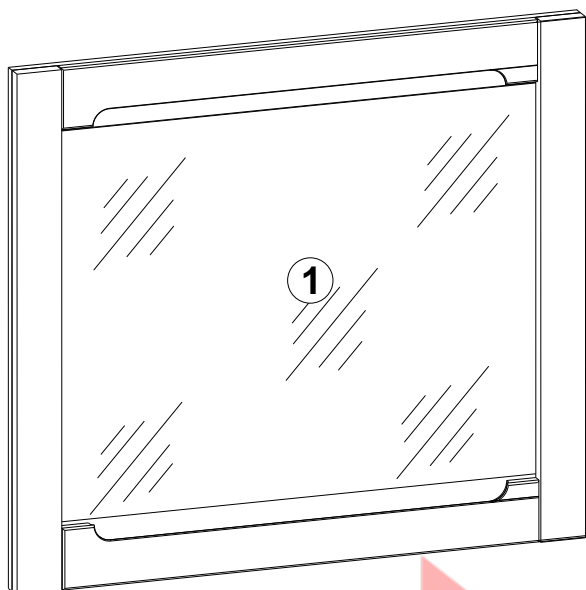

A	B	C	D
1	S404-0044	591	1090

98 mm 395 mm 98 mm

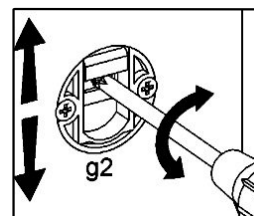
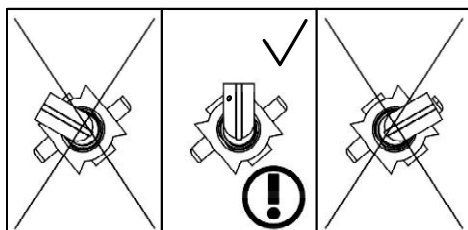
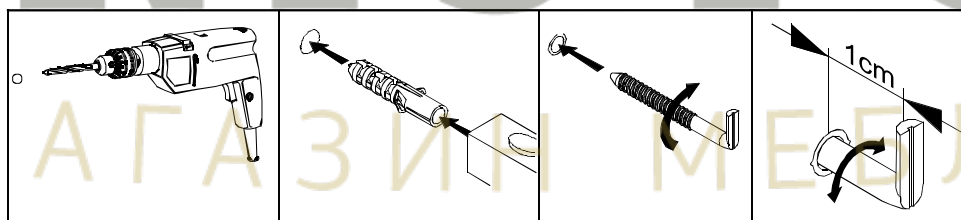
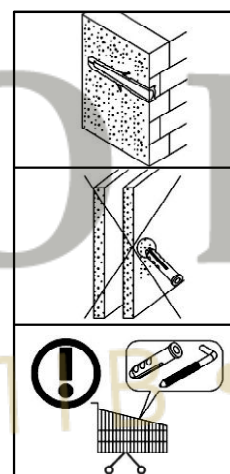
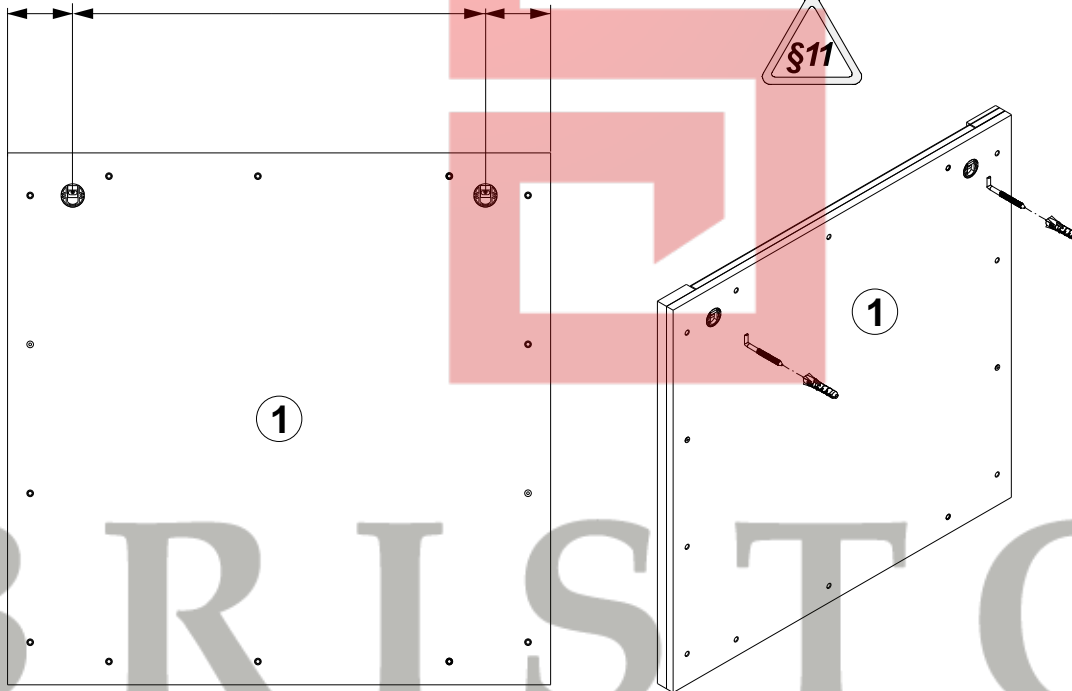

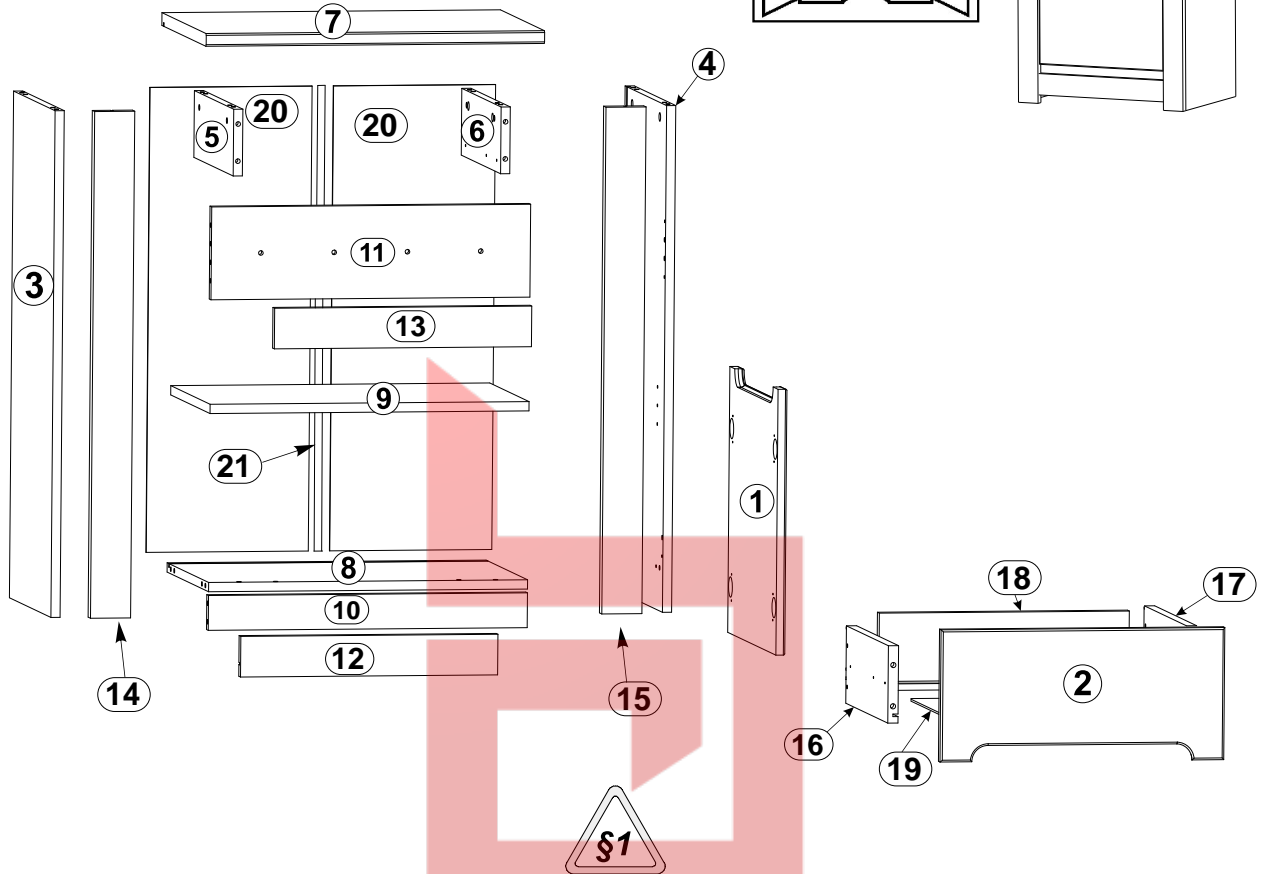
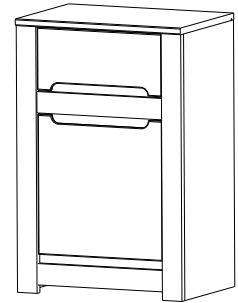
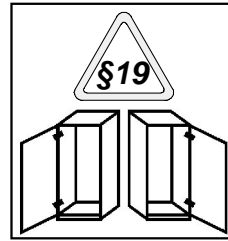
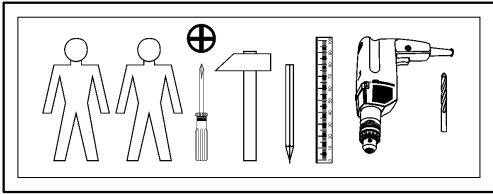

A	B	C		D					
					11	S404-4026	557	160	2/3
1	S404-0012	446	458	3/3	12	S404-5026	449	70	2/3
2	S404-0011	446	205	3/3	13	S404-5027	449	70	2/3
3	S404-1033	873	384	1/3	14	S404-5024	873	70	1/3
4	S404-1034	873	384	1/3	15	S404-5025	873	70	1/3
5	S404-1035	115	364	2/3	16	S404-5108	350	120	2/3
6	S404-1036	115	364	2/3	17	S404-5109	350	120	2/3
7	S404-2009	591	410	2/3	18	S404-5110	393	120	2/3
8	S404-3017	557	384	2/3	19	S404-9006	408	349	2/3
9	S404-3018	557	364	2/3	20	S404-9303	801	283	1/3
10	S404-4025	557	60	2/3	21	LH-790	790	14	1/3

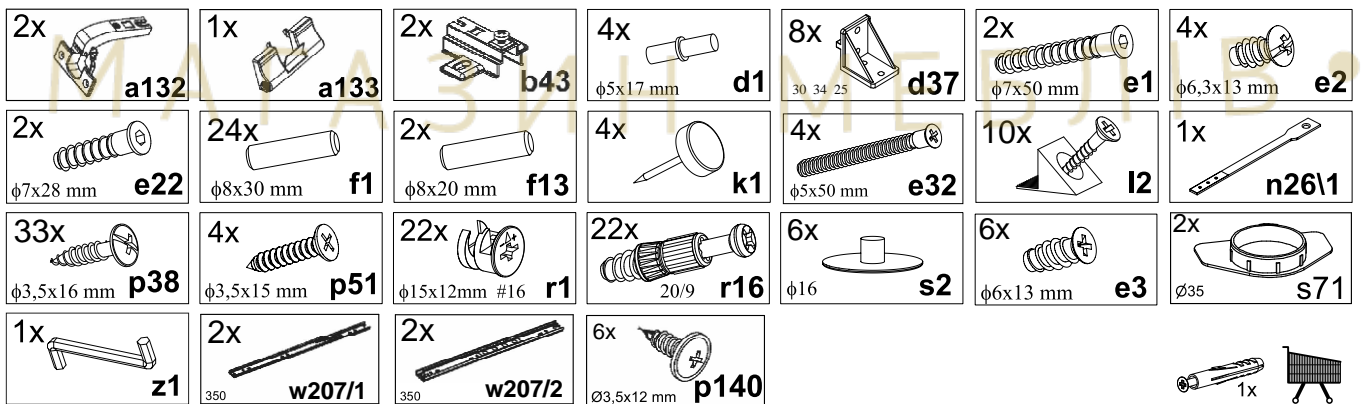

1

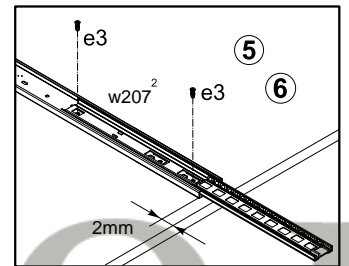
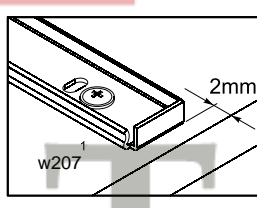
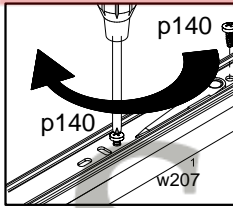
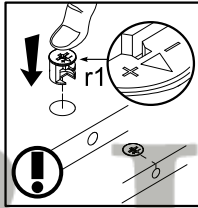
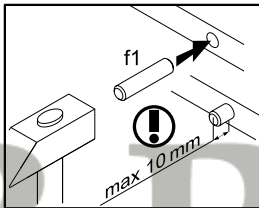
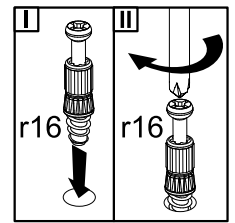
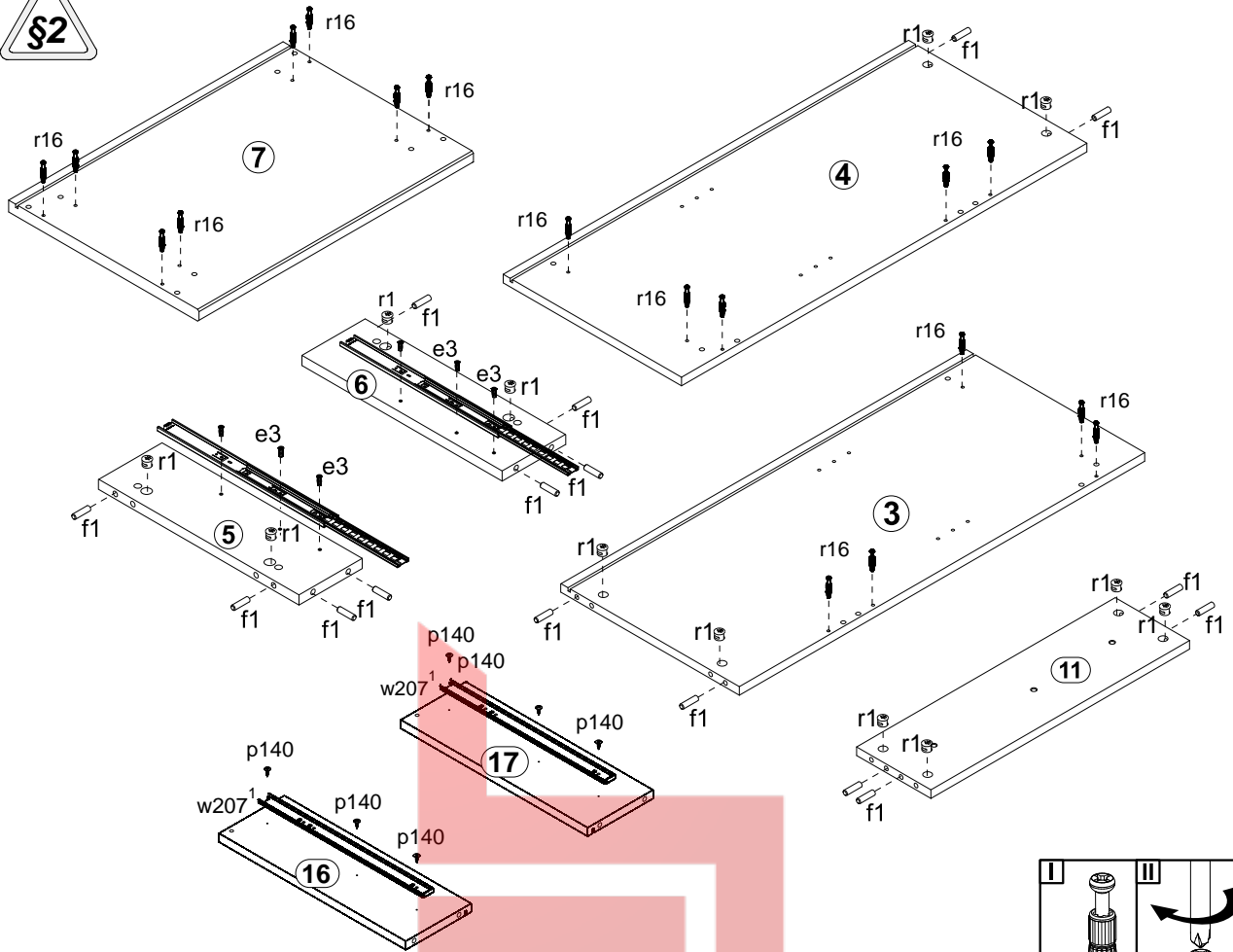

2

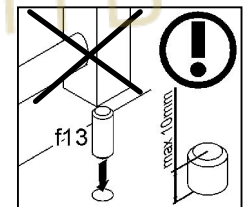
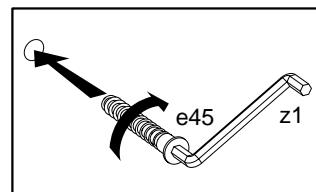
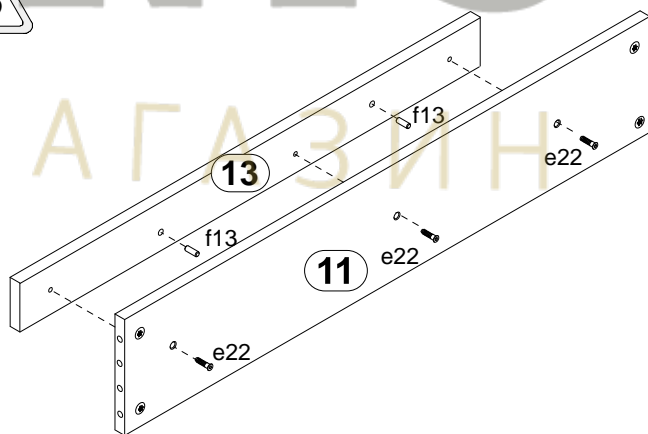

3

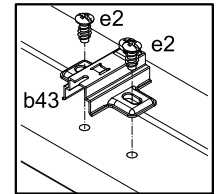
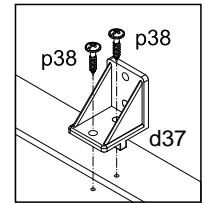
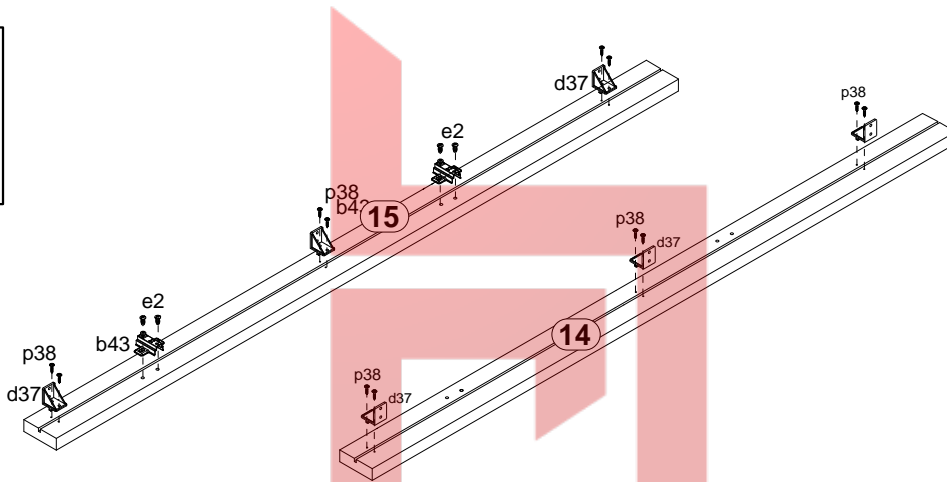
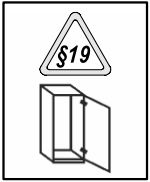
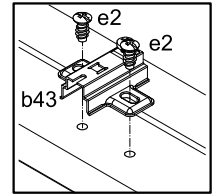
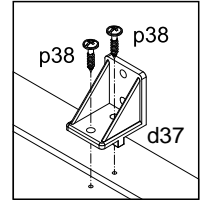
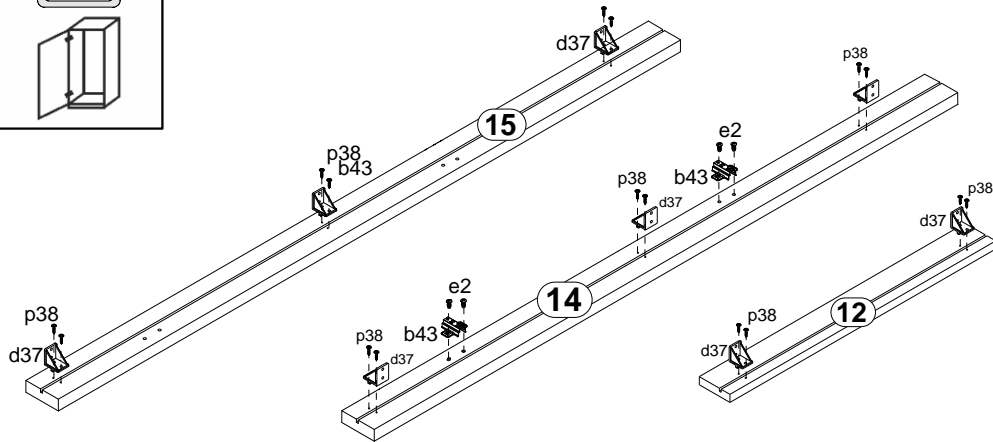
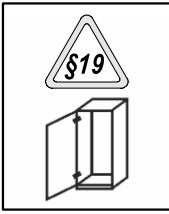

4

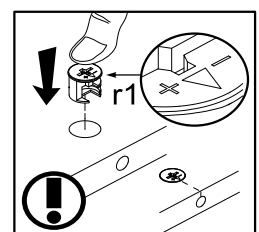
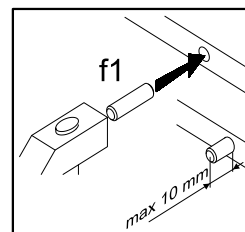
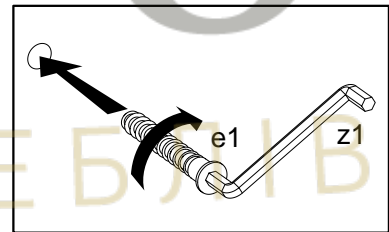
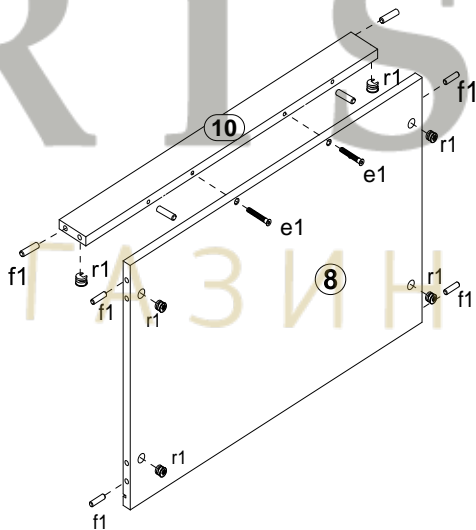

5

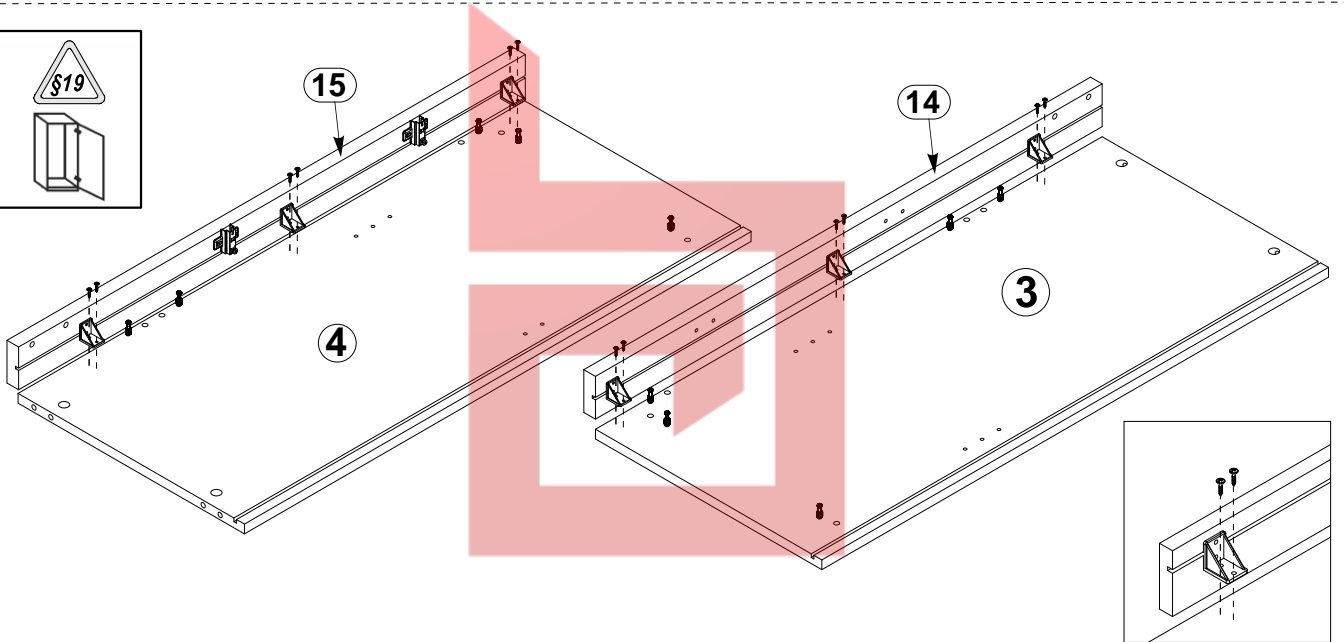
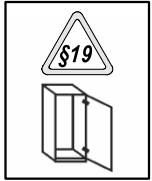
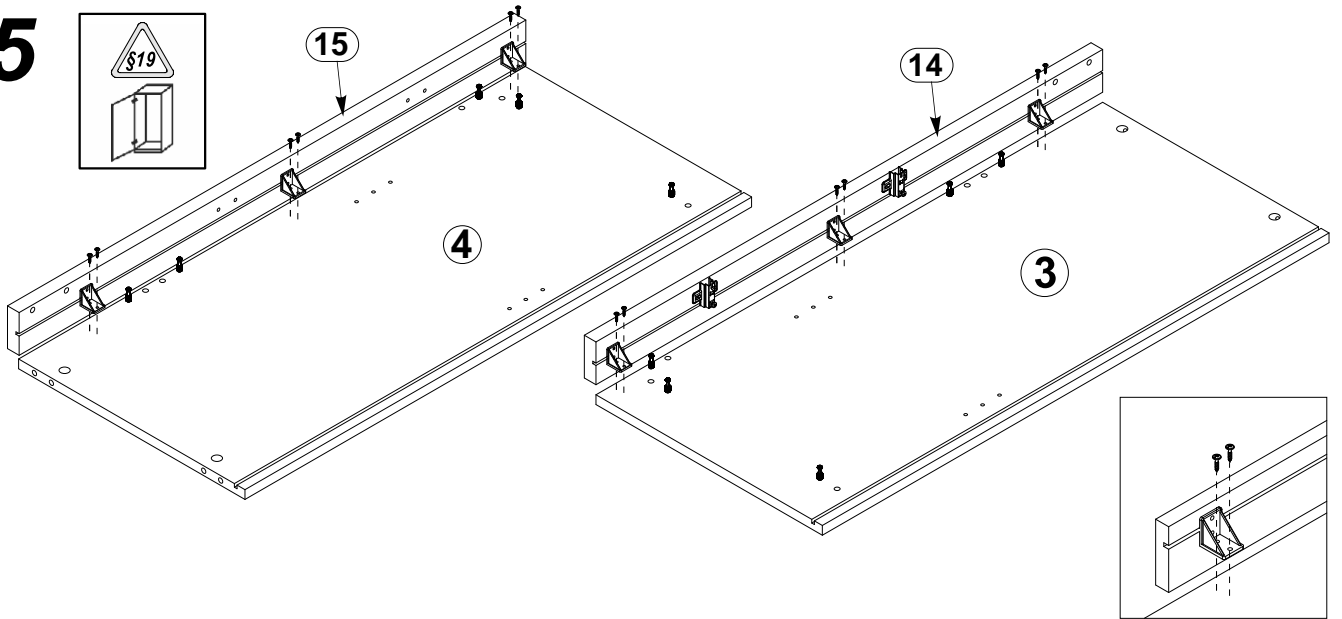
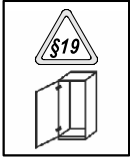

6

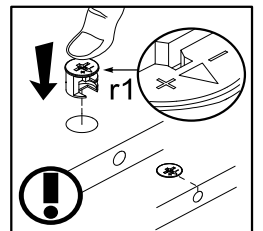
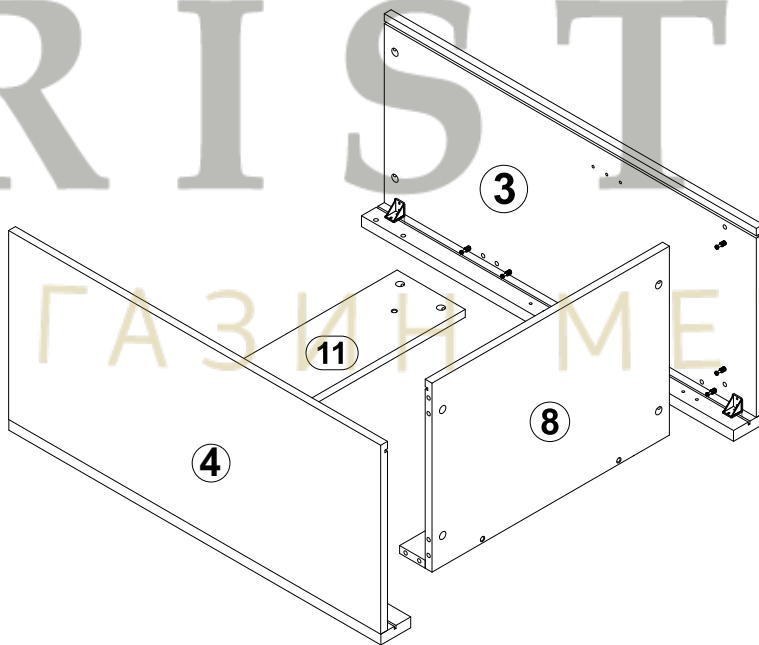

7

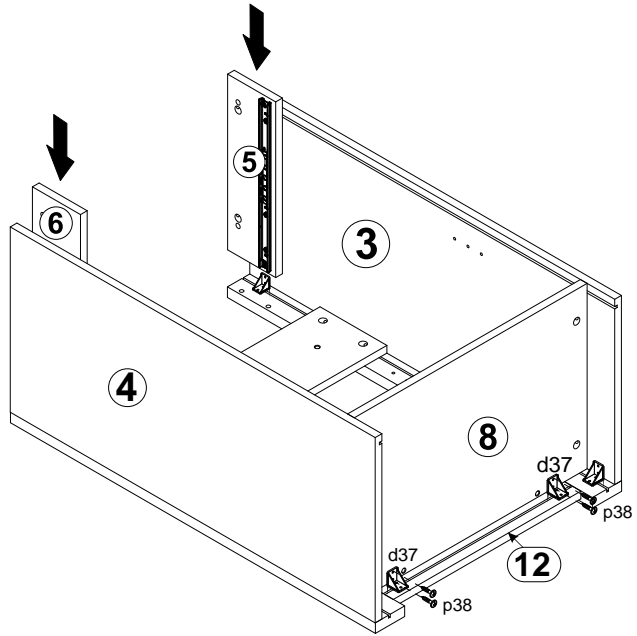
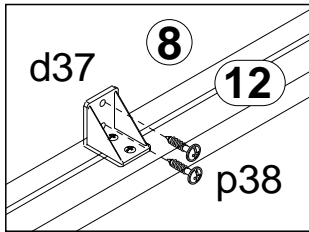

8

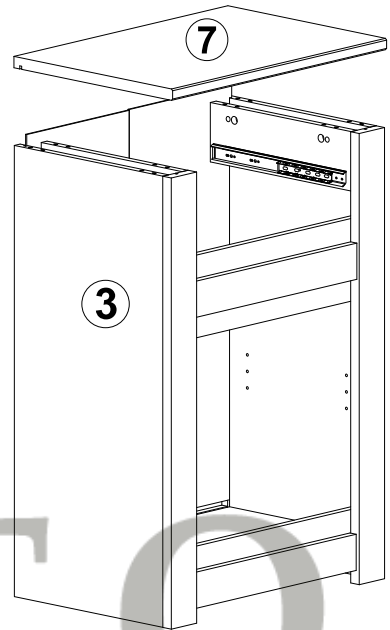
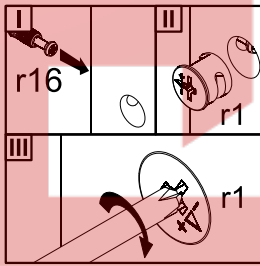
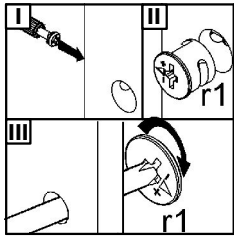
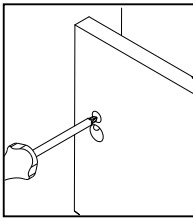

9

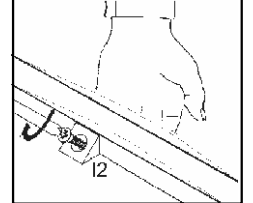
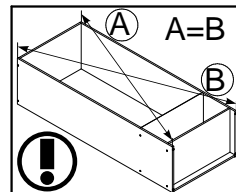
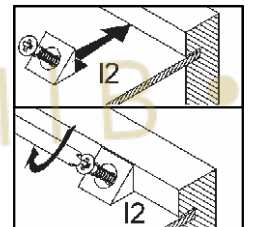
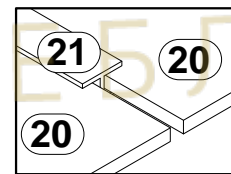
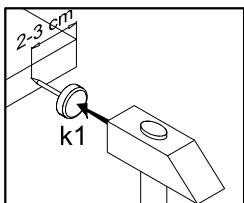
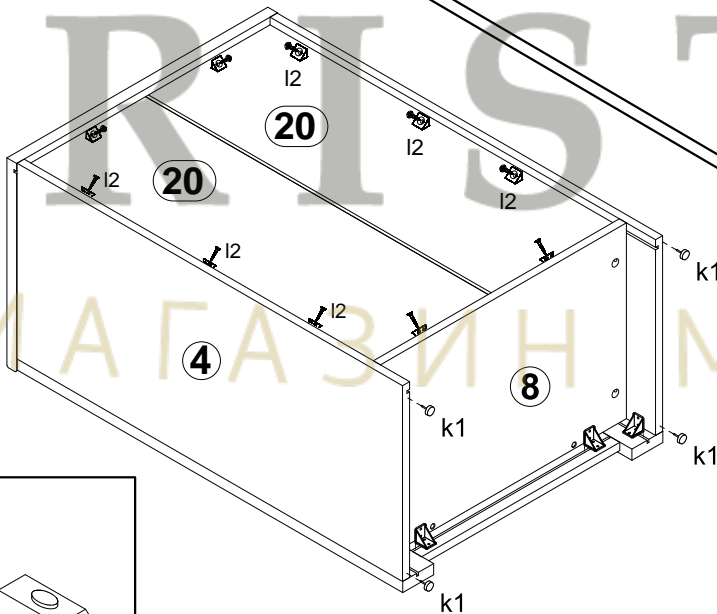

10

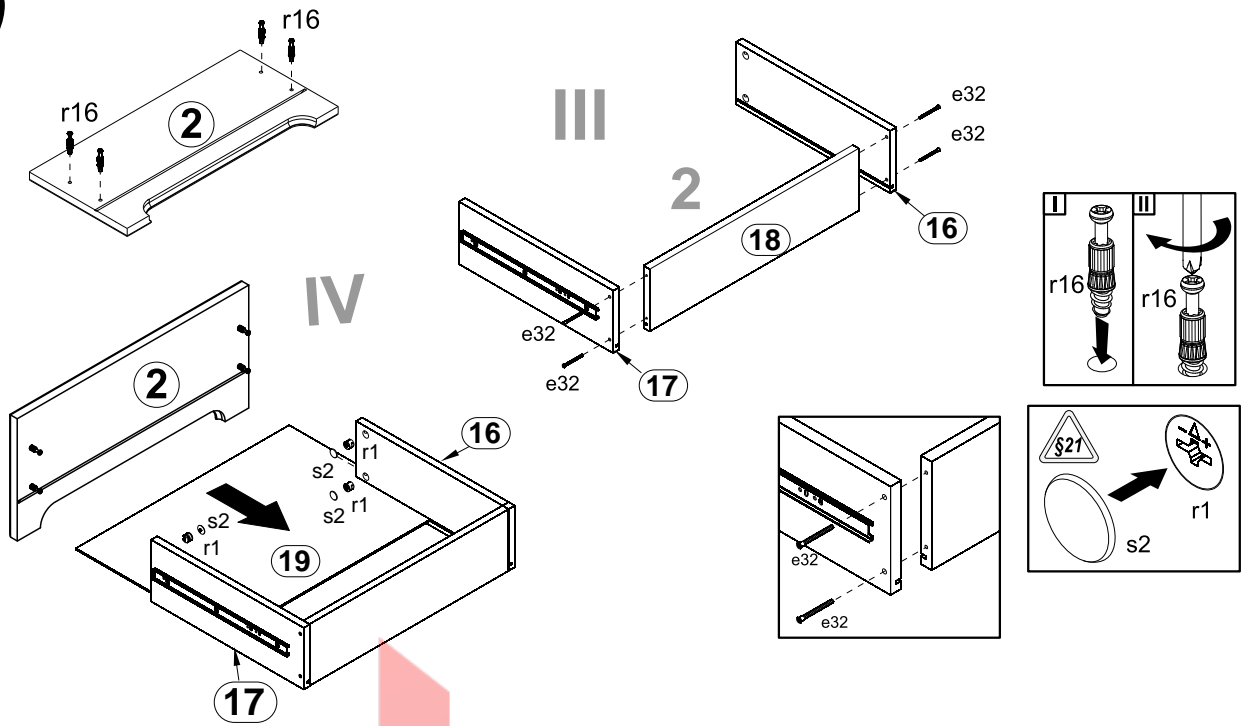

11

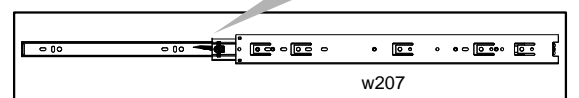
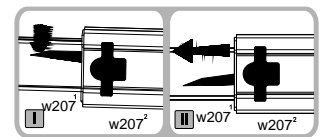
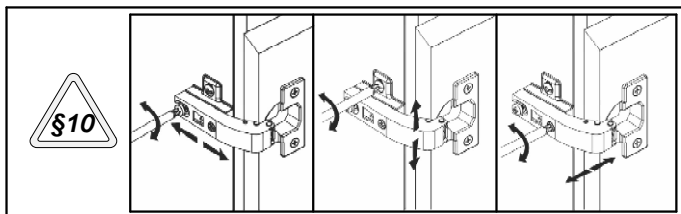
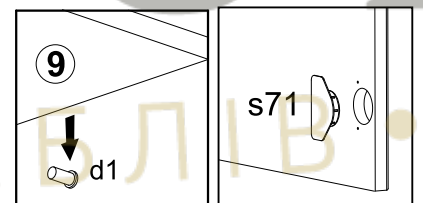
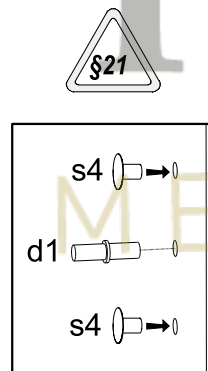
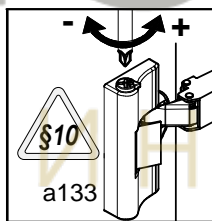
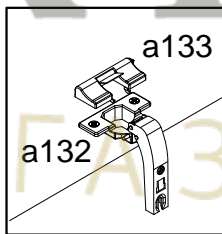
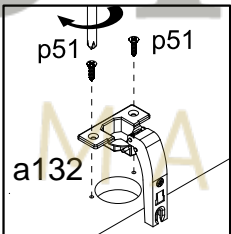
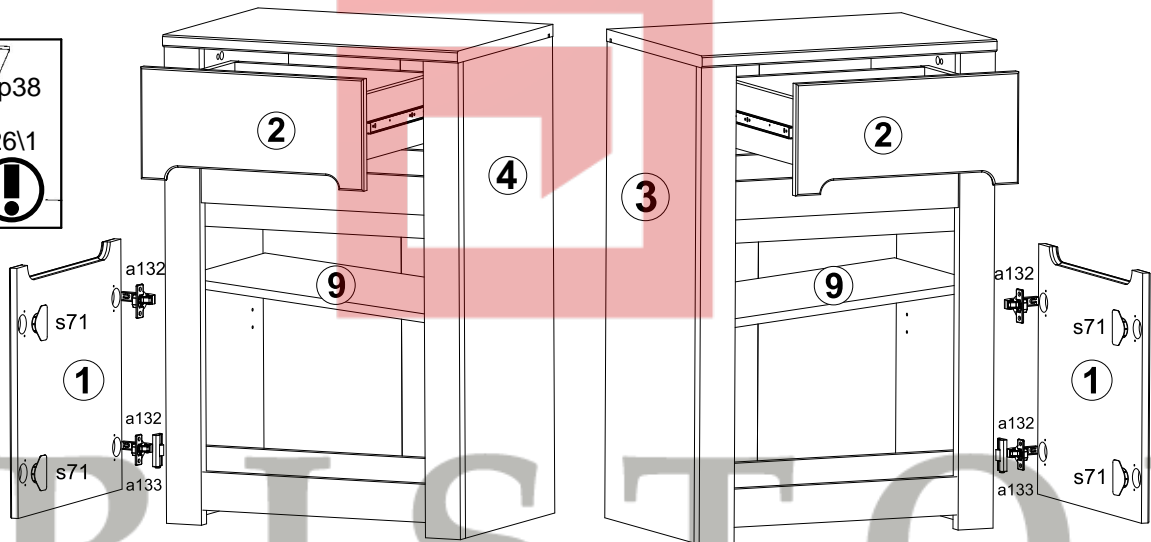
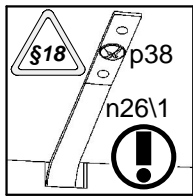

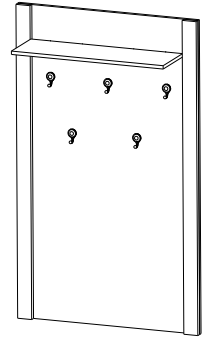
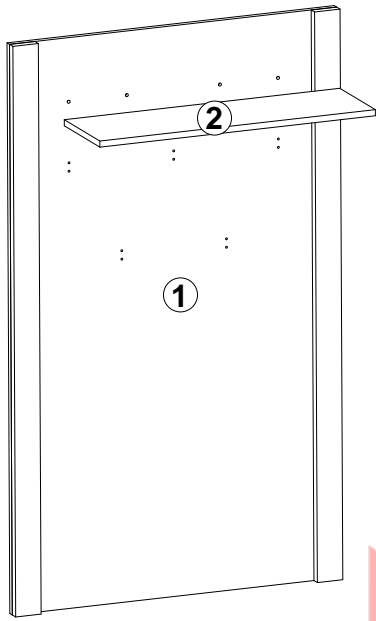

A	B	C	D
1	S404-0045	1495	900
2	S404-3019	758	230

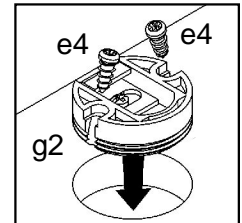
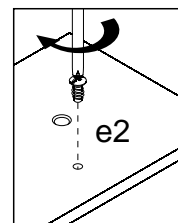
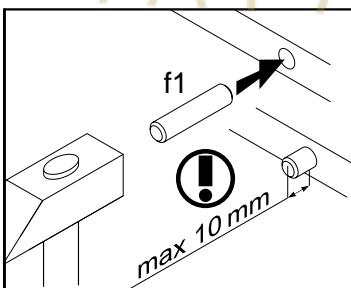
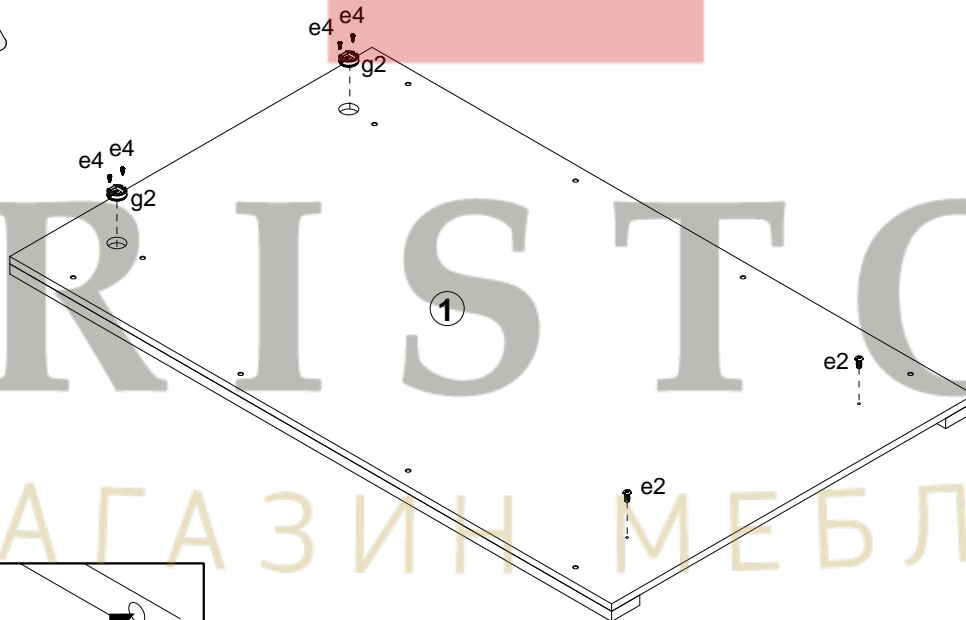
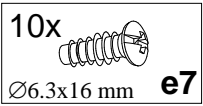
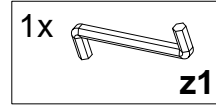
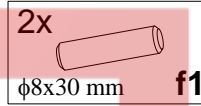
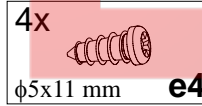
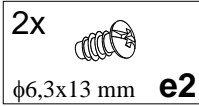
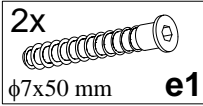

2

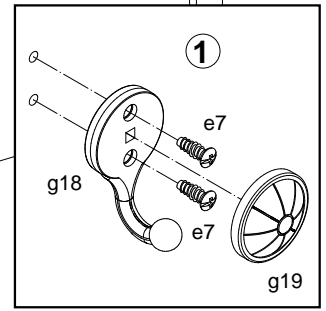
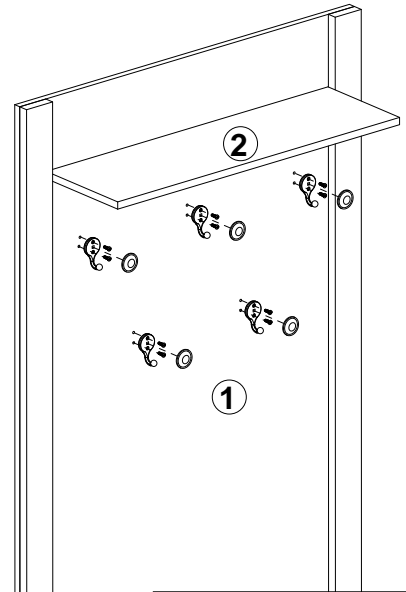
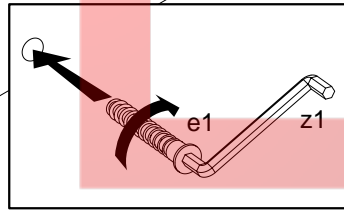
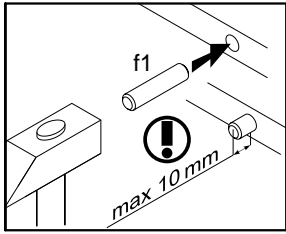
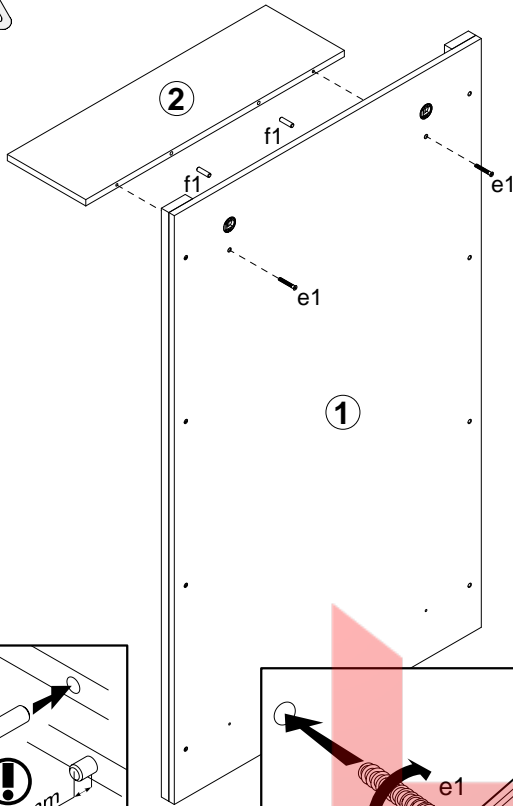

3



162 mm 576 mm 162 mm

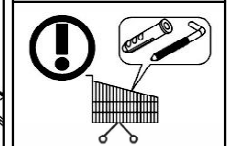
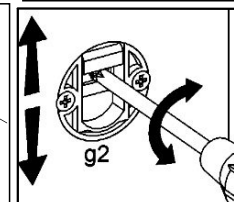
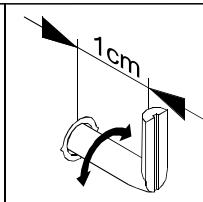
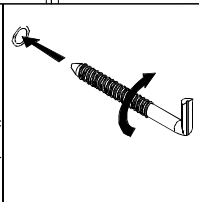
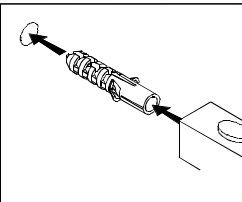
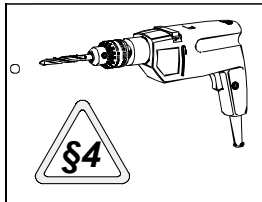
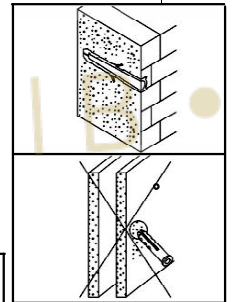
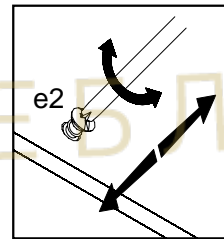
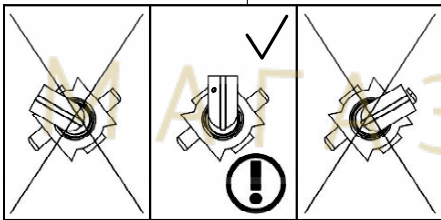
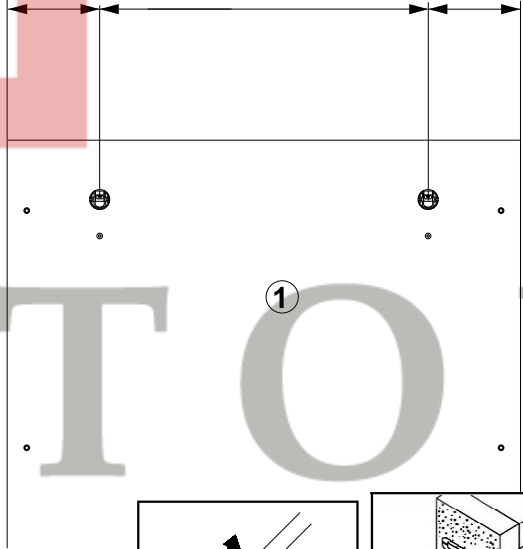

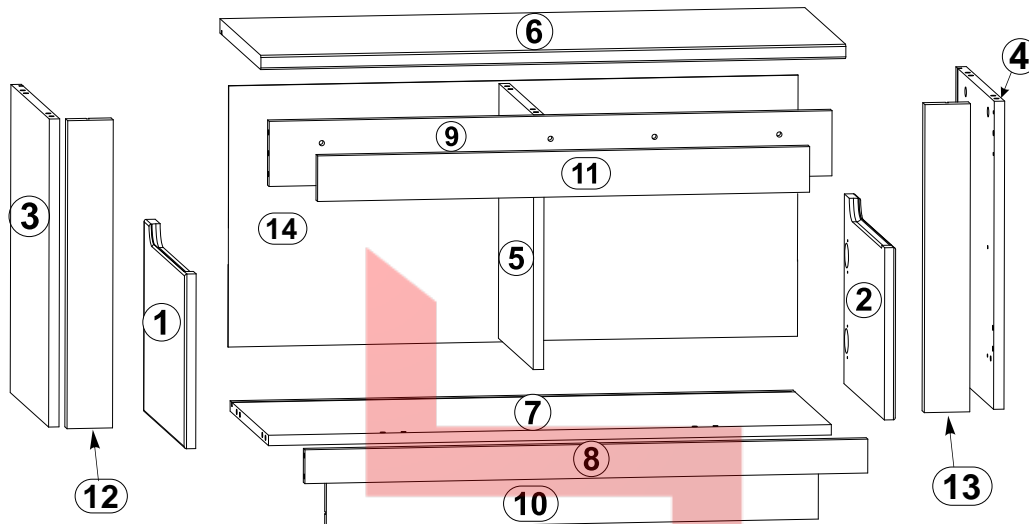
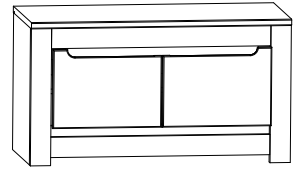
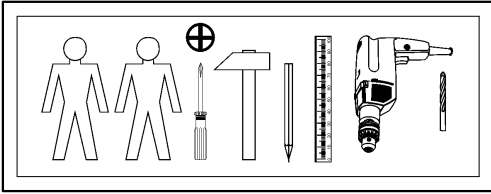

A	B	C	D
1	S404-0052	376	271
2	S404-0053	376	271
3	S404-1038	473	384
4	S404-1039	473	384
5	S404-1041	391	348
6	S404-2010	900	410
7	S404-3020	866	384
8	S404-4031	866	52



9	S404-4032	866	100
10	S404-5009	758	70
11	S404-5010	758	70
12	S404-5013	473	70
13	S404-5014	473	70
14	S404-9506	401	876

4x a132	2x a133	4x b43	7x d37	4x φ7x50 mm e1	9x φ6,3x13 mm e2	3x Ø7x28 mm e22
20x φ8x30 mm f1	2x φ8x20 mm f13	4x k1	12x l2	6x l1	1x n26\1	33 φ3,5x16 mm p38
8x φ3,5x15 mm p51	14x φ15x12mm #16 r1	14x 20/9 r16	1x 30x30\64 mm k38\8	1x 42,5x42,5\4 mm k38\3	6x φ16 s2	1x z1

1

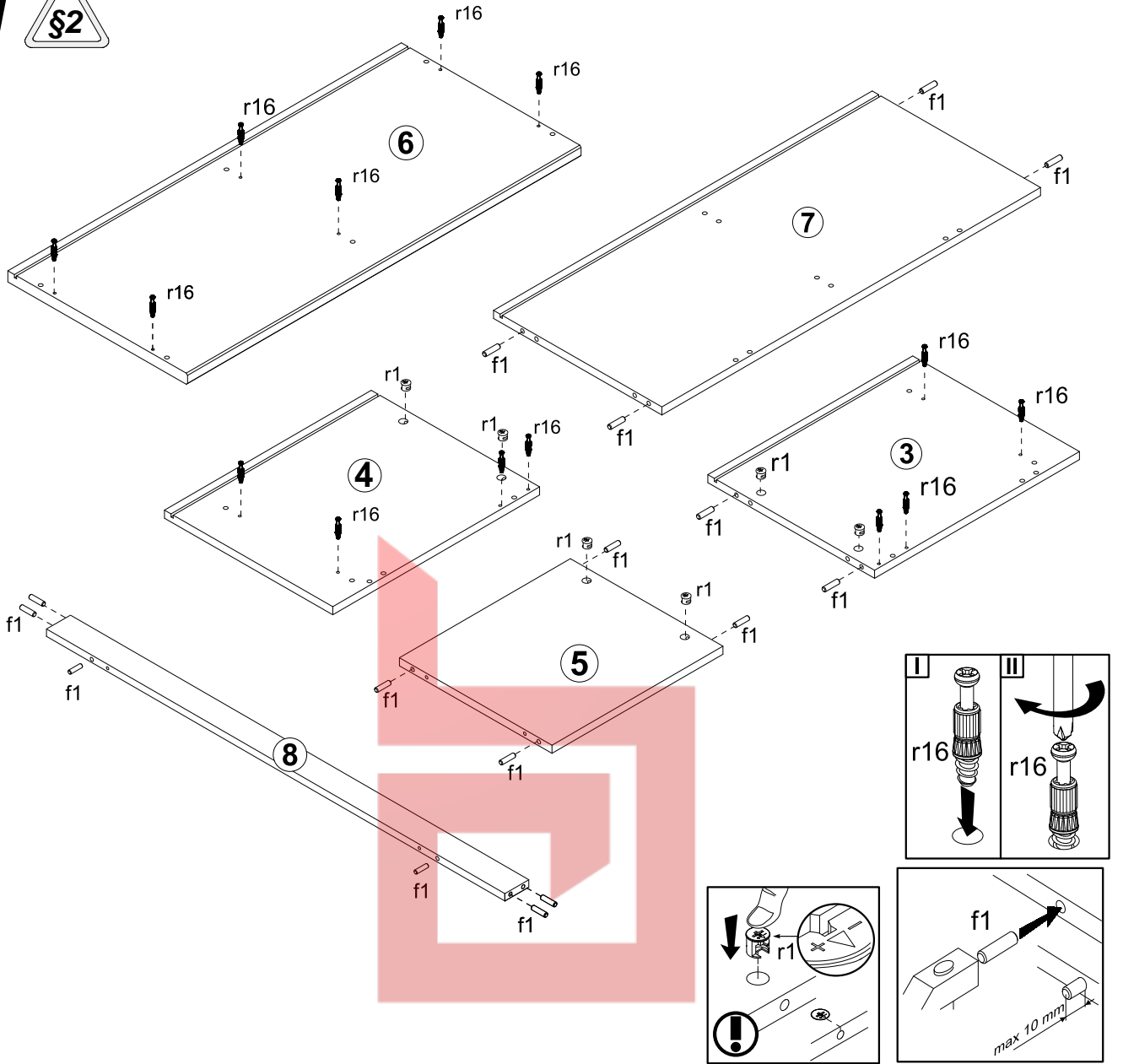

2

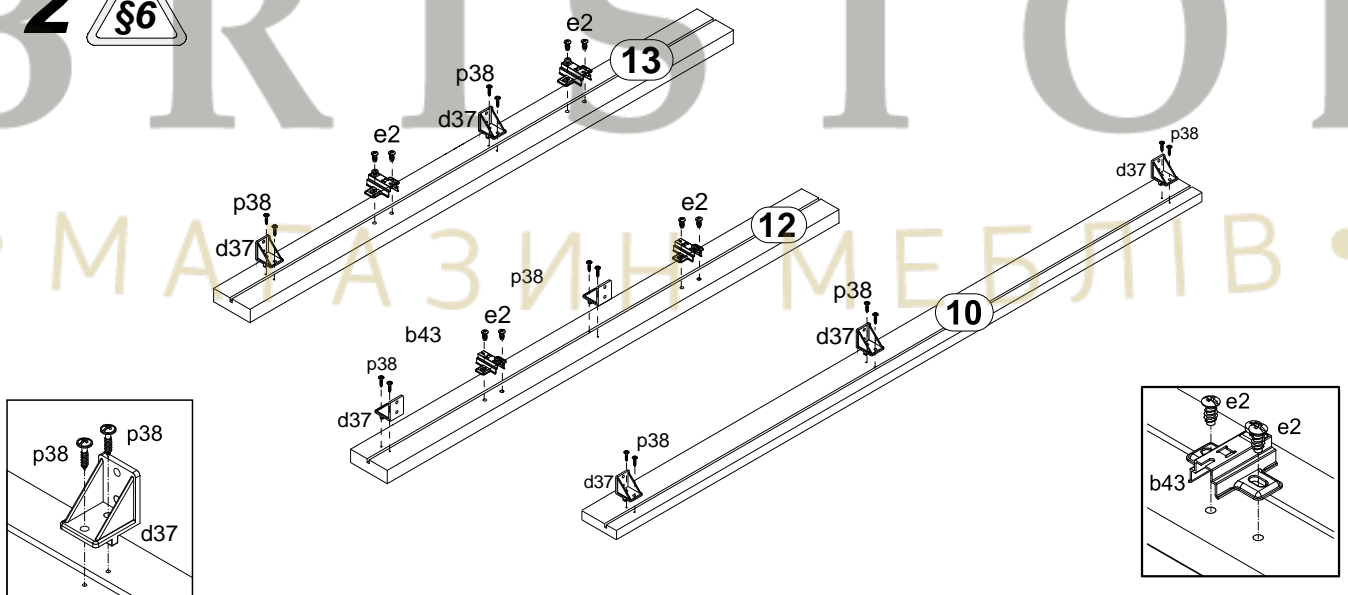

3

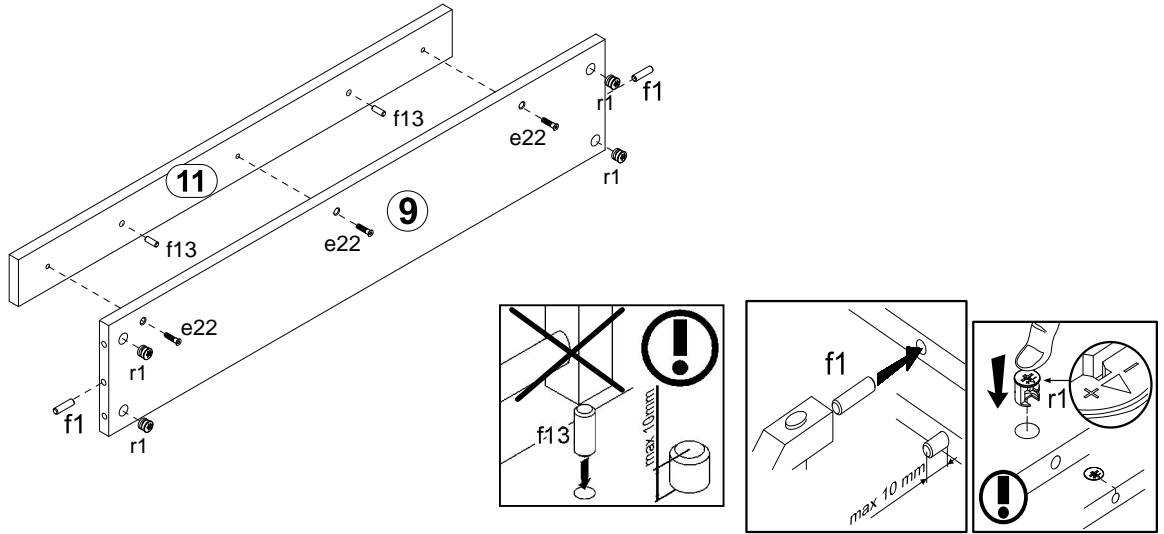

4

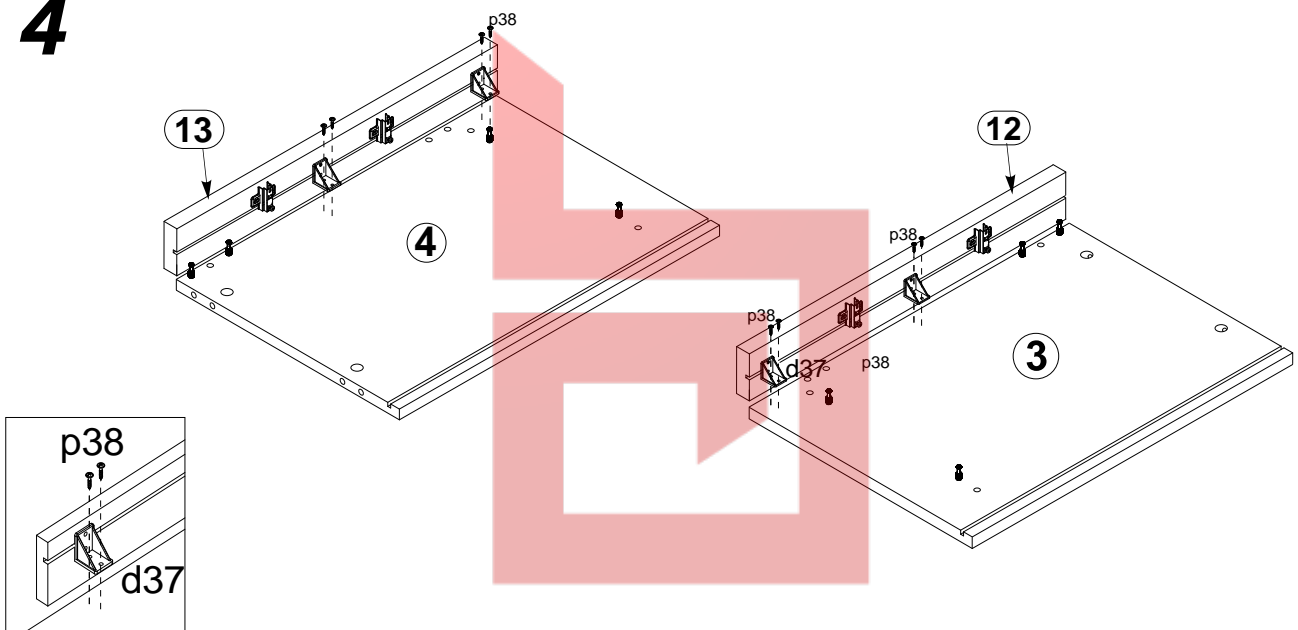

5

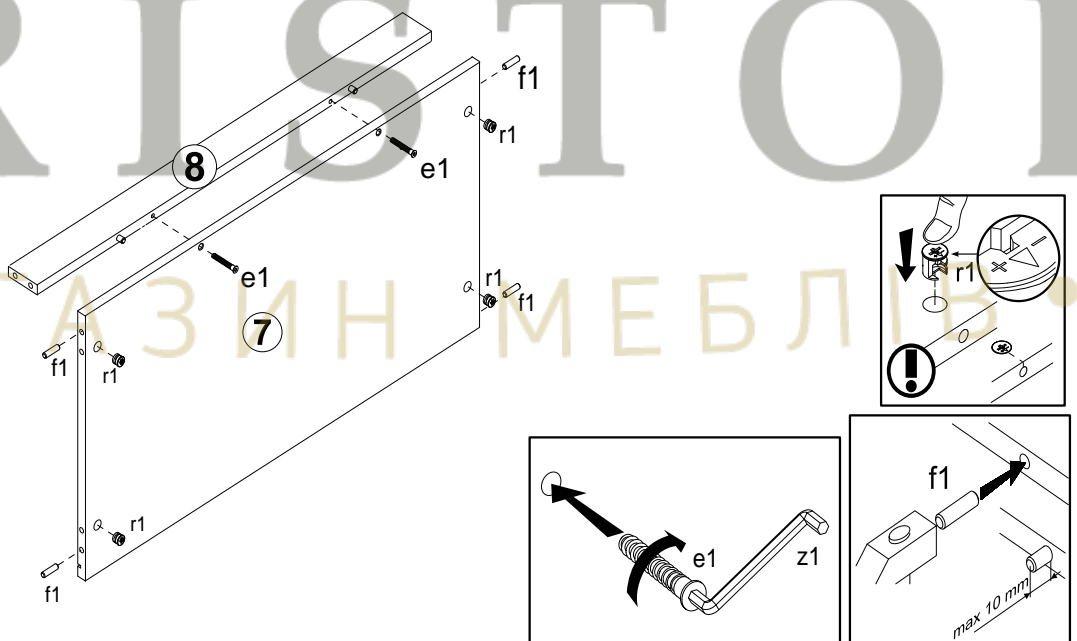

6

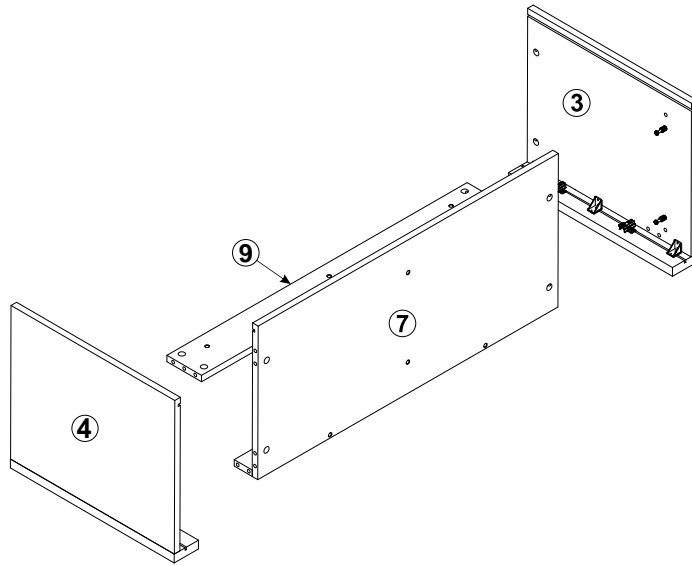
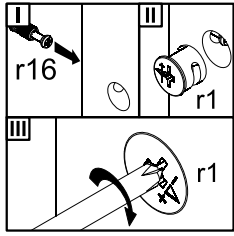

7

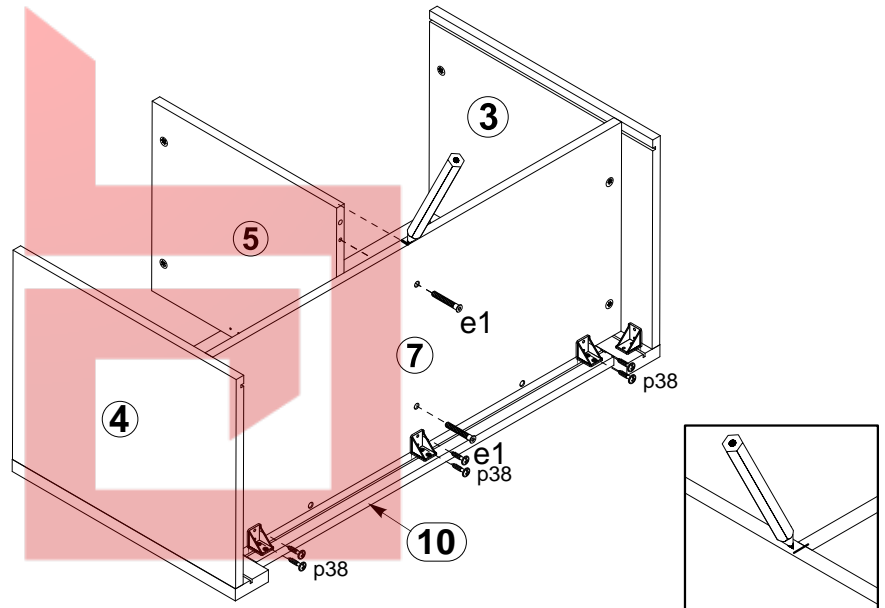
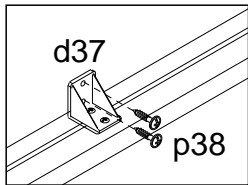
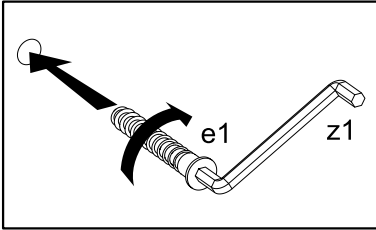

8

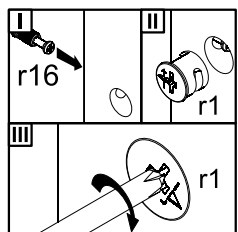
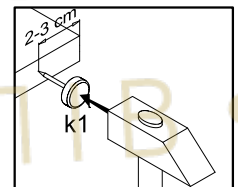
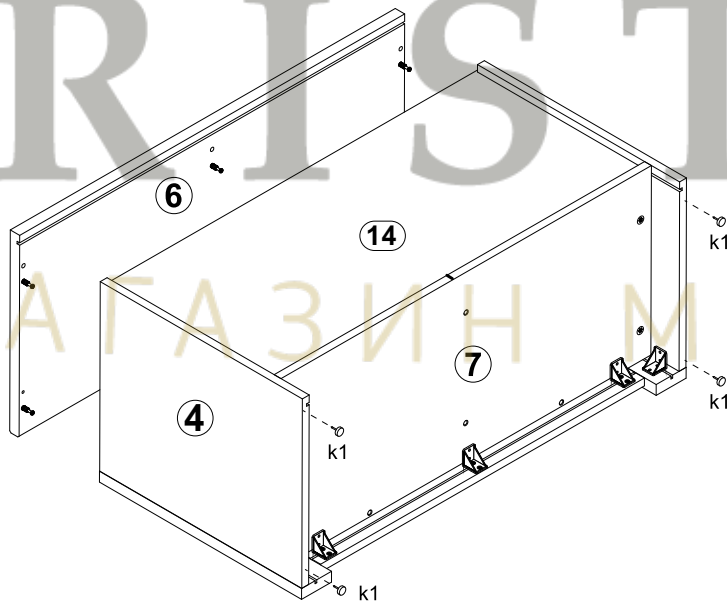

9

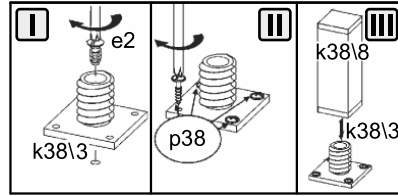
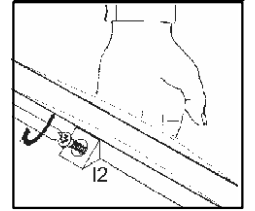
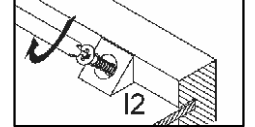
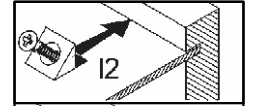
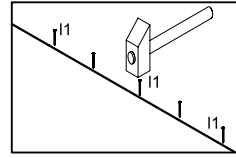
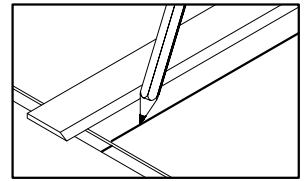
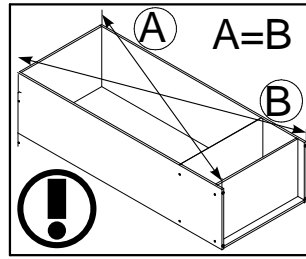
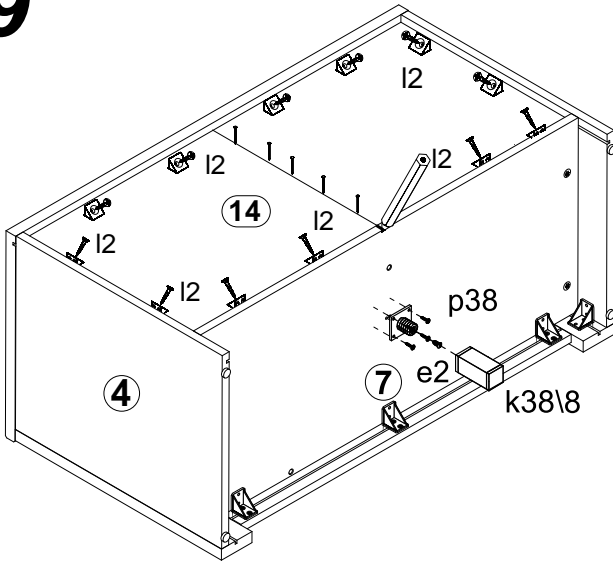

10

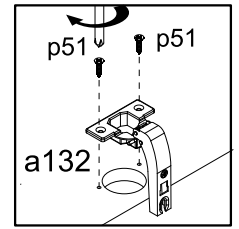
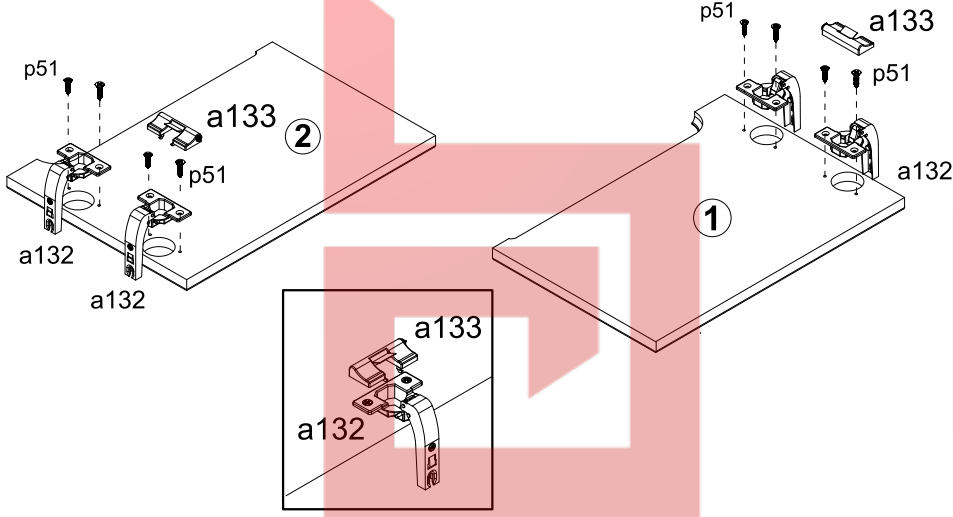

11

