

# Instalation manual

SOLO: KOM\_2D4S

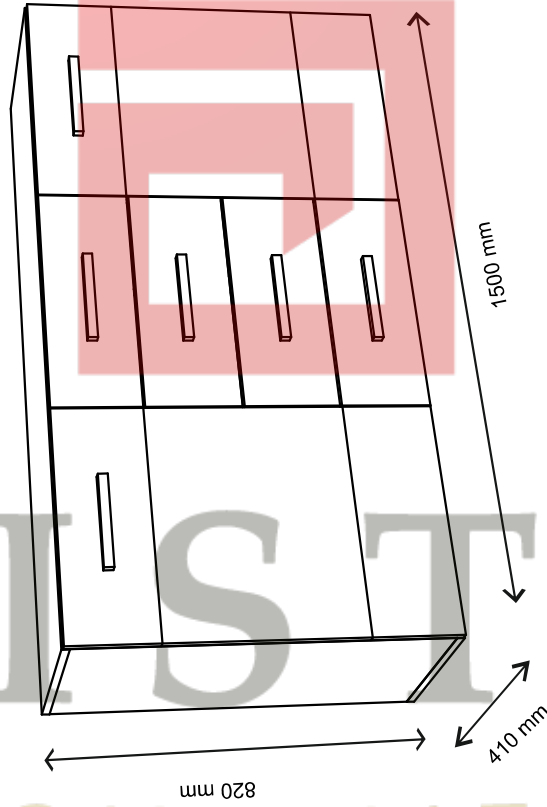
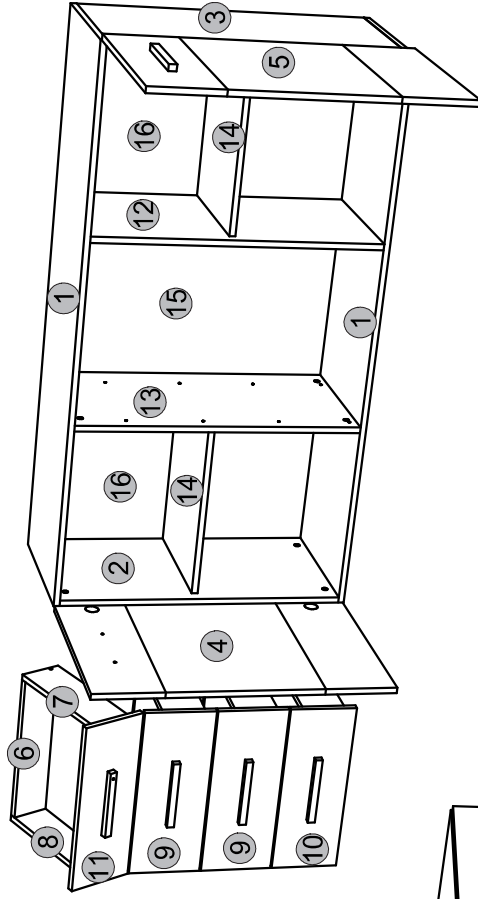
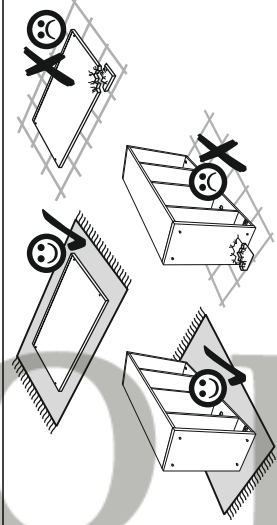
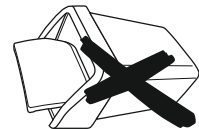
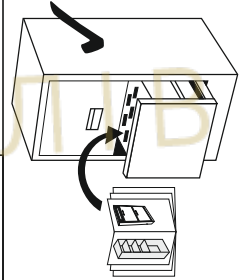
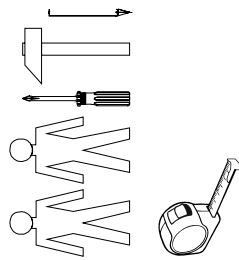
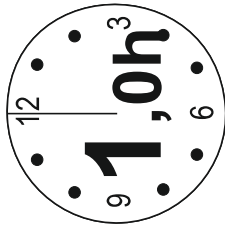
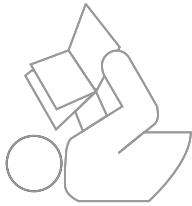

Element symbol	Dimensions	Code	Package
1	394	SN-202	1/1
2	762	SN-103	1/1
3	762	SN-103	1/1
4	788	SN-015	2/2
5	788	SN-016	2/2
6	428	SN-404	1/1
7	350	SN-405	1/1
8	350	SN-406	1/1
9	498	SN-006	2/2
10	498	SN-007	2/2
11	498	SN-008	2/2
12	762	SN-105	1/1
13	762	SN-106	1/1
14	474	SN-309	1/1
15	777	SN-603	2/2
16	777	SN-604	2/2
17	442	SN-605	2/2

10x	p52	2x	f3	2x	p17	2x	n14	60x	l1
32x	f1	6x	p42	6x	s1	6x	p18	24x	r16
4x	b119	8x	e1	8x	s2	24x	r1	4x	a144
1x	y1	1x	z1	8x	d1	60x	p25	4x	L-350

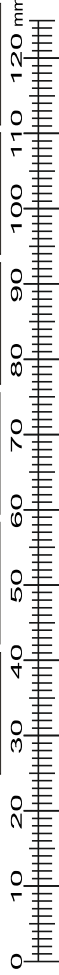

3

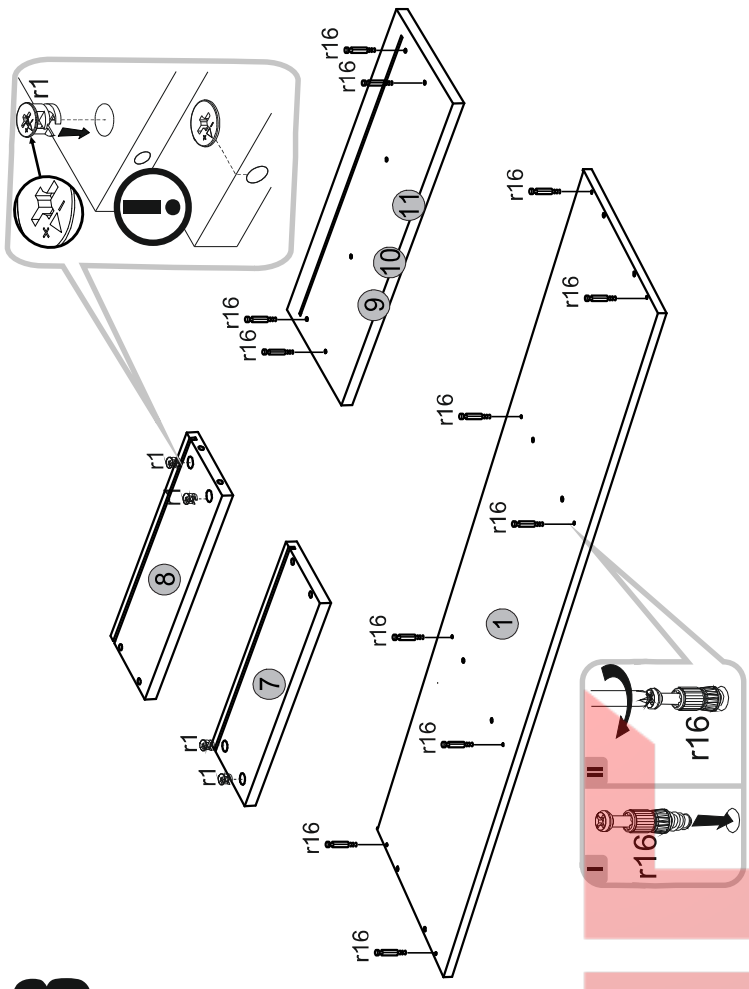

4

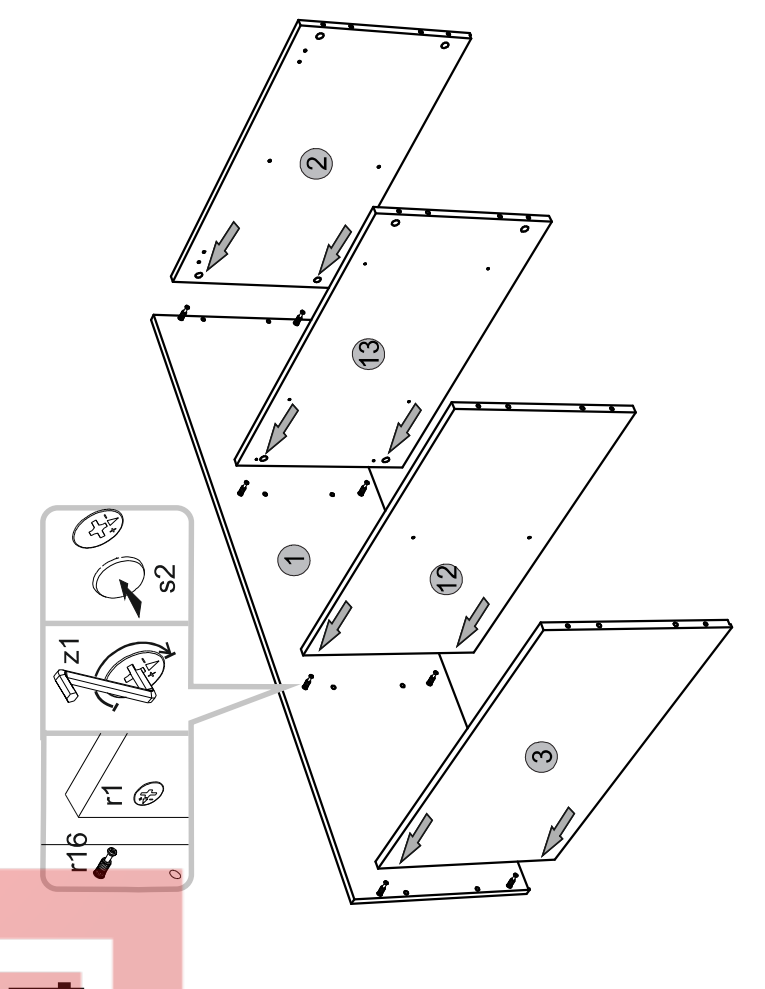

1

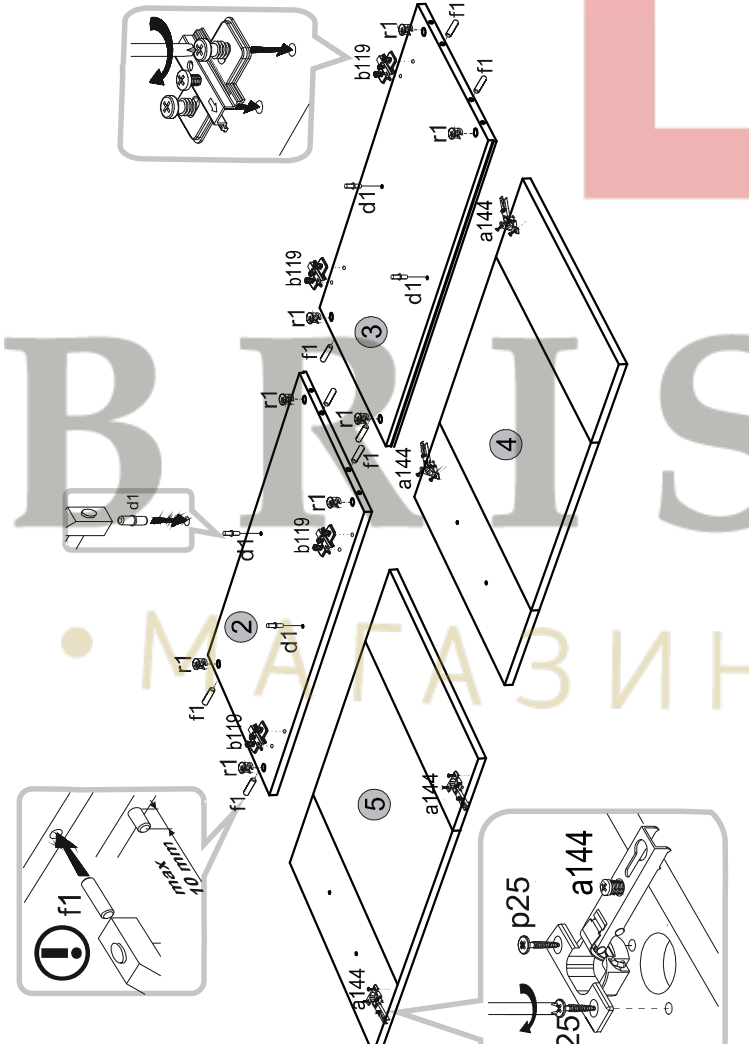

2

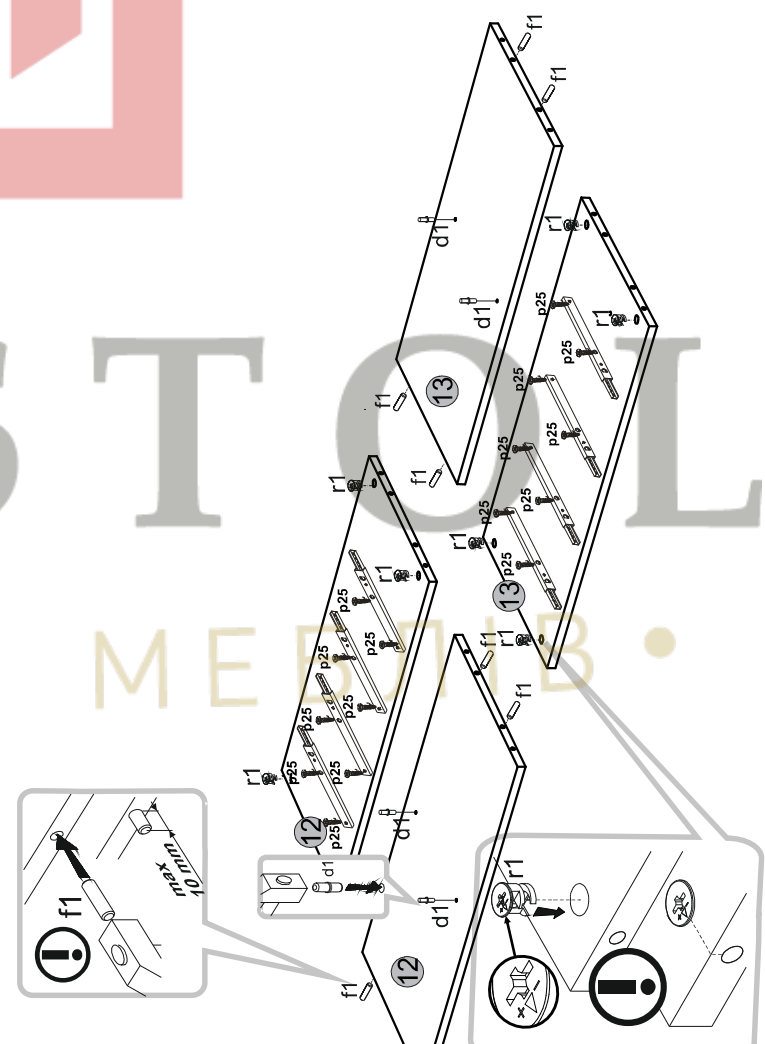

5

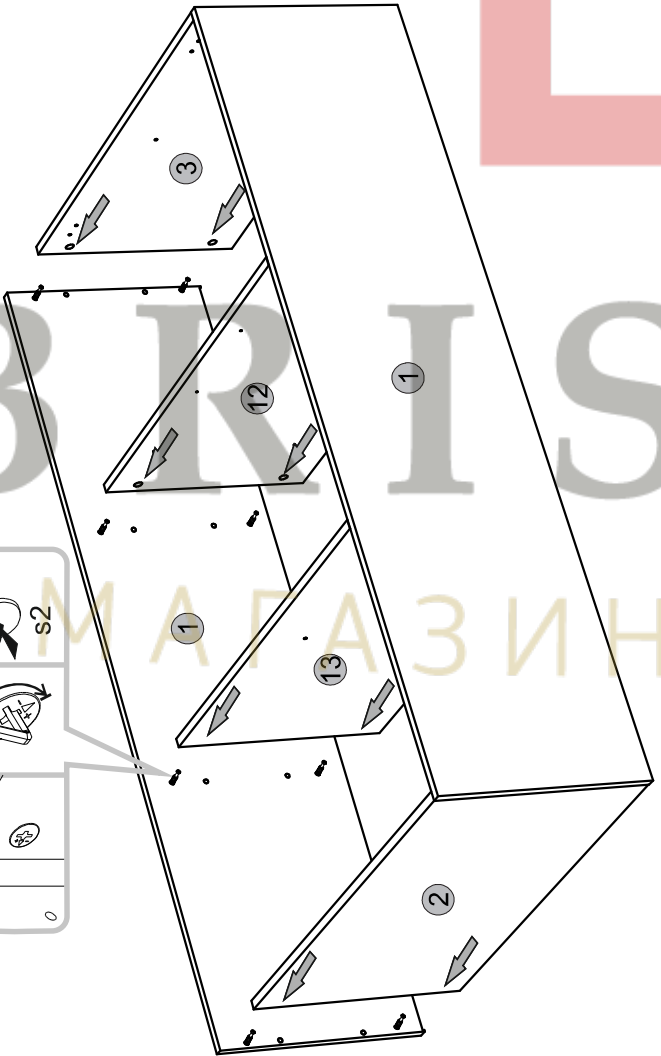
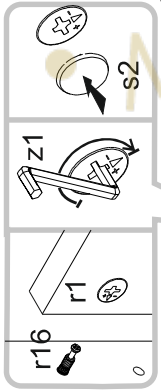

7

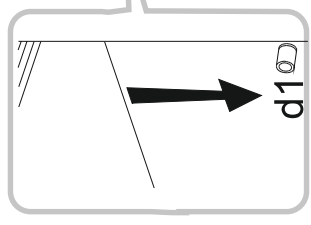
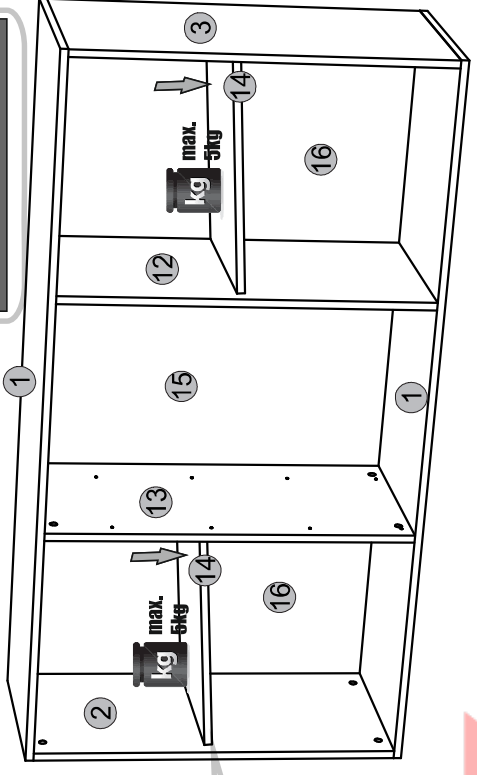

8

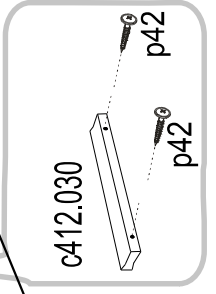
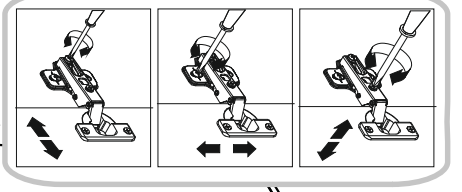
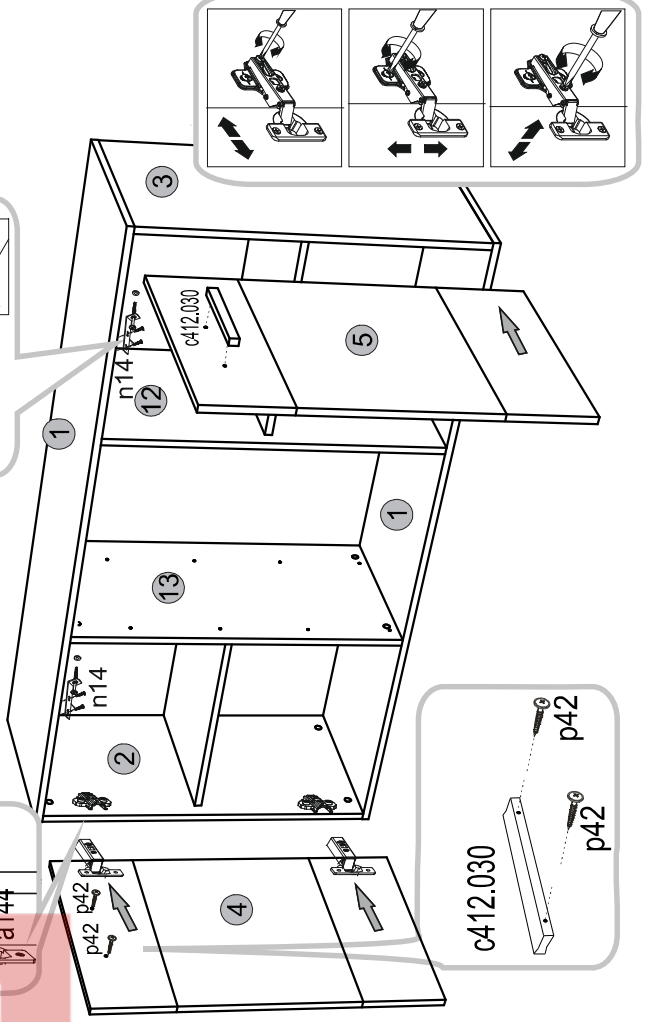
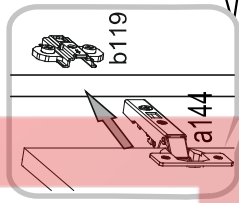

6

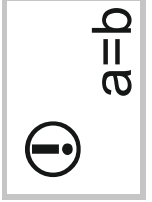
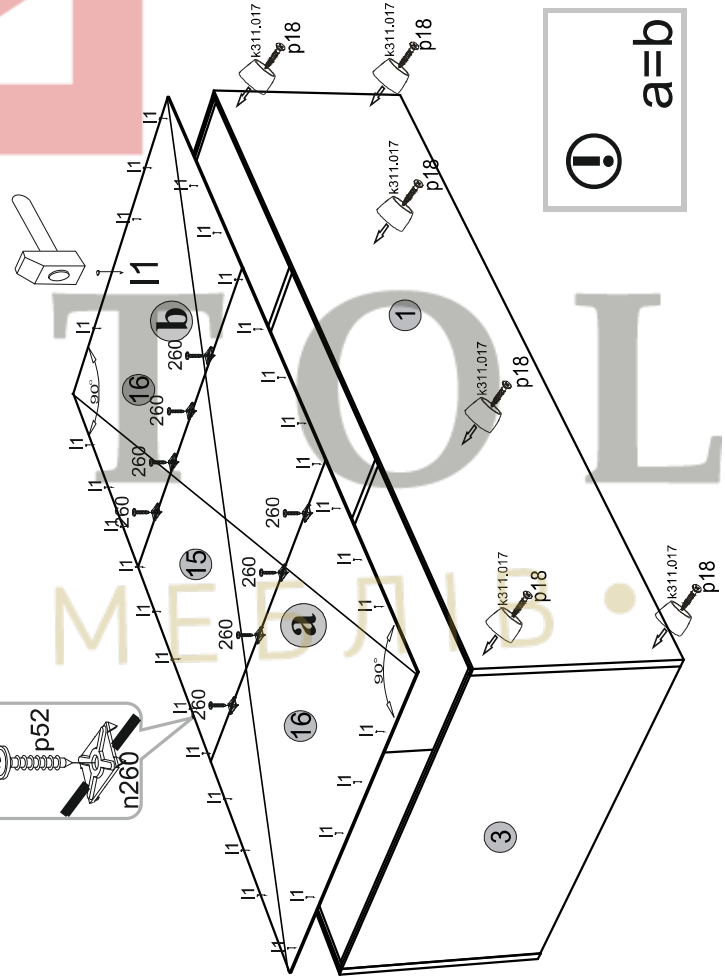
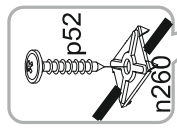

a=b

9

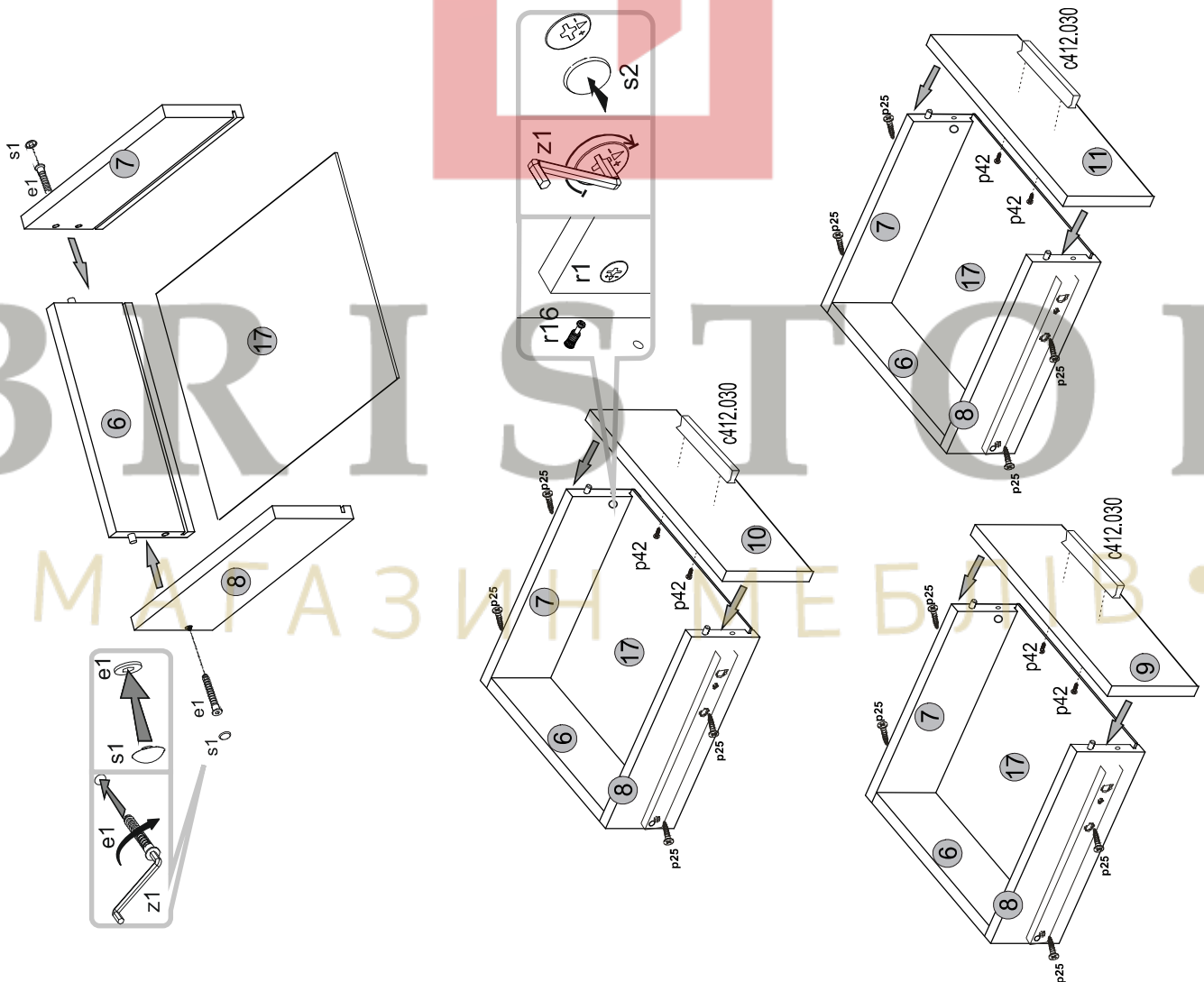

10

