

Instalation manual

SOLO: SZF_3D2S

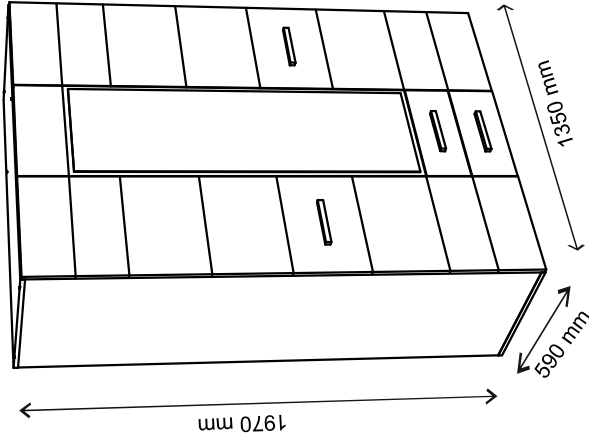

Element symbol	Dimensions	Code	Package
1	574 16	SN-121	1/1
2	571 16	SN-123	1/1
3	448 16	SN-023	1/1
4	500 120	SN-410	1/1
5	500 120	SN-411	1/1
6	376 16	SN-412	1/1
7	1913 574	SN-122	1/1
8	1932 450	SN-613	1/1
9	1932 442	SN-614	1/1
10	390 498	SN-615	1/1
11	1350 574	SN-208	2/2
12	875 571	SN-310	2/2
13	451 571	SN-311	2/2
14	353 571	SN-124	2/2
15	182 448	SN-546	2/2
16	188 448	SN-547	2/2
17	425 571	SN-312	2/2
18	1350 574	SN-209	2/2
19	970 448	SN-009	3/3
20	970 448	SN-011	3/3
21	970 448	SN-010	3/3
22	970 448	SN-012	3/3

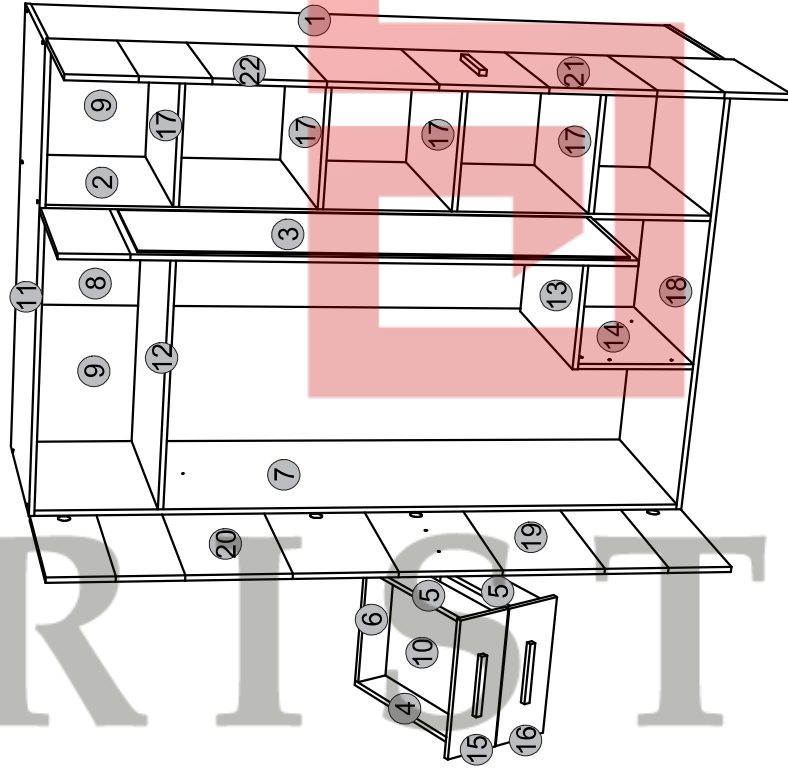
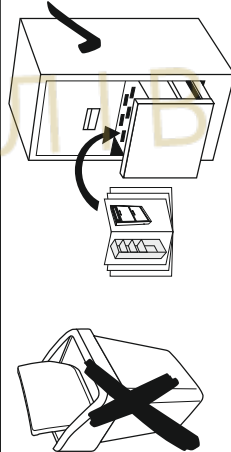
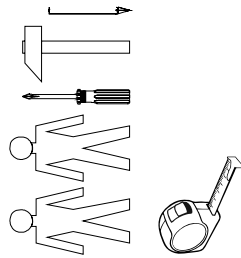
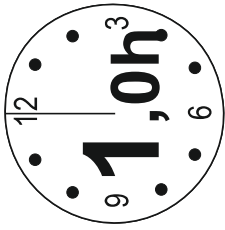
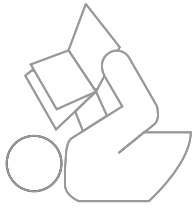
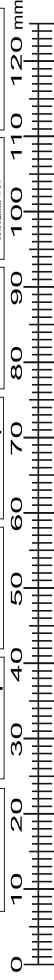
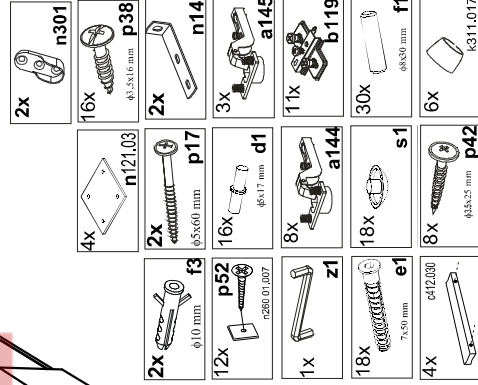

1

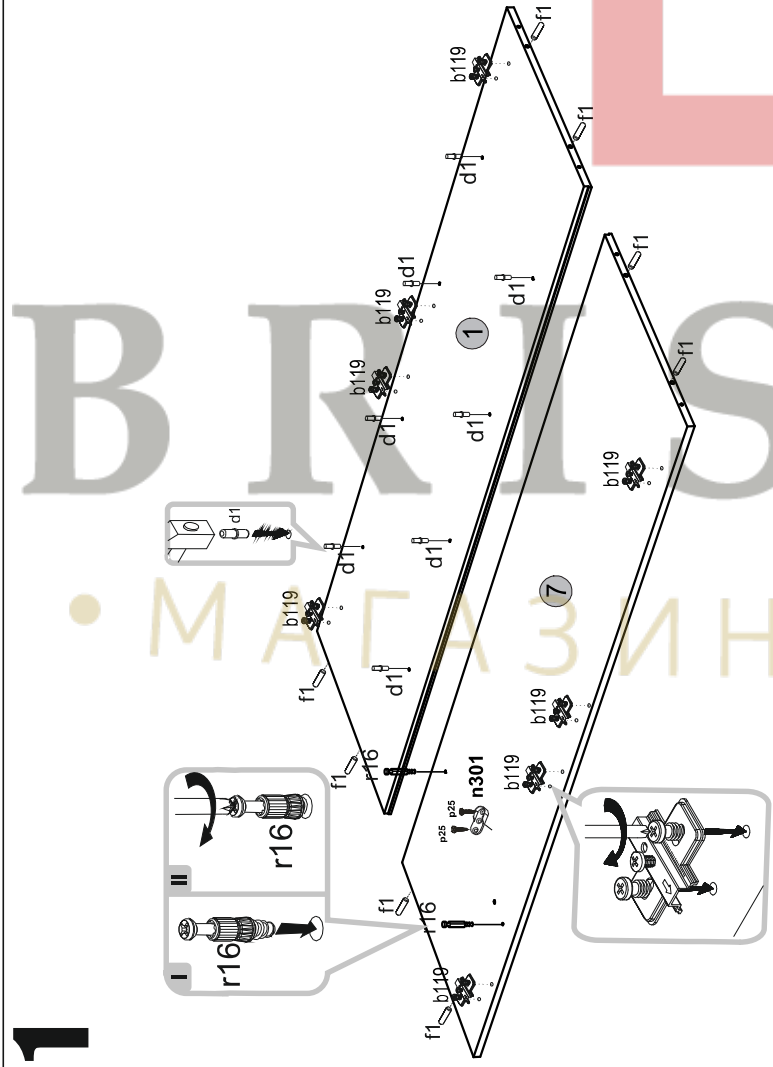

3

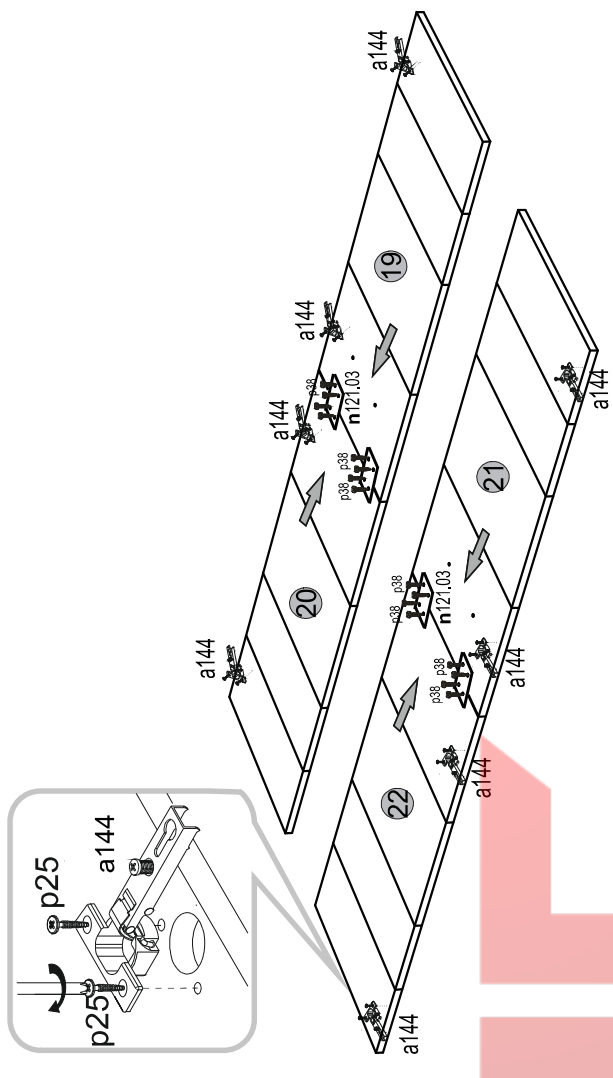

2

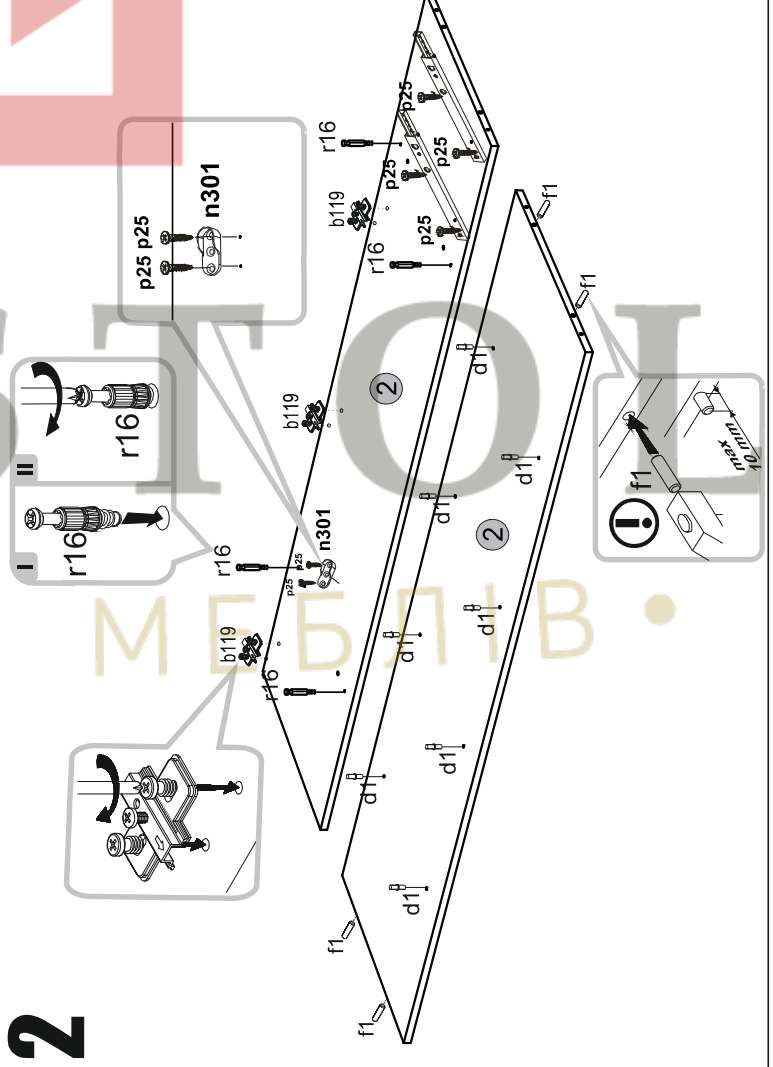

4

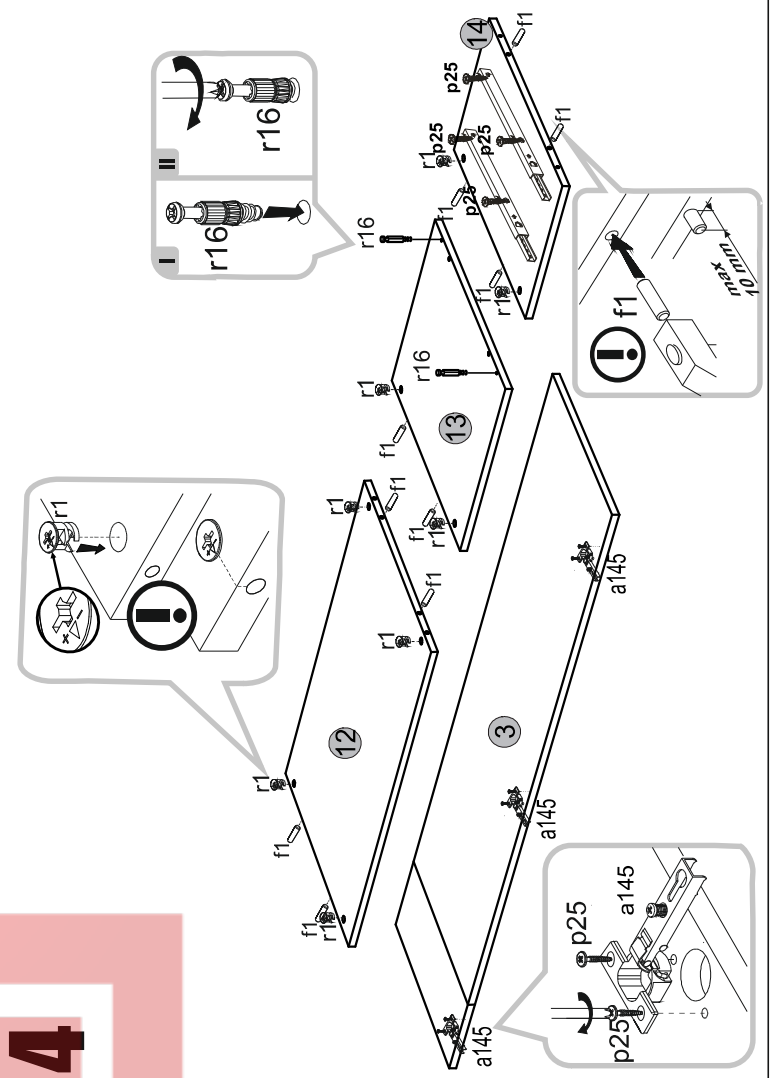

5

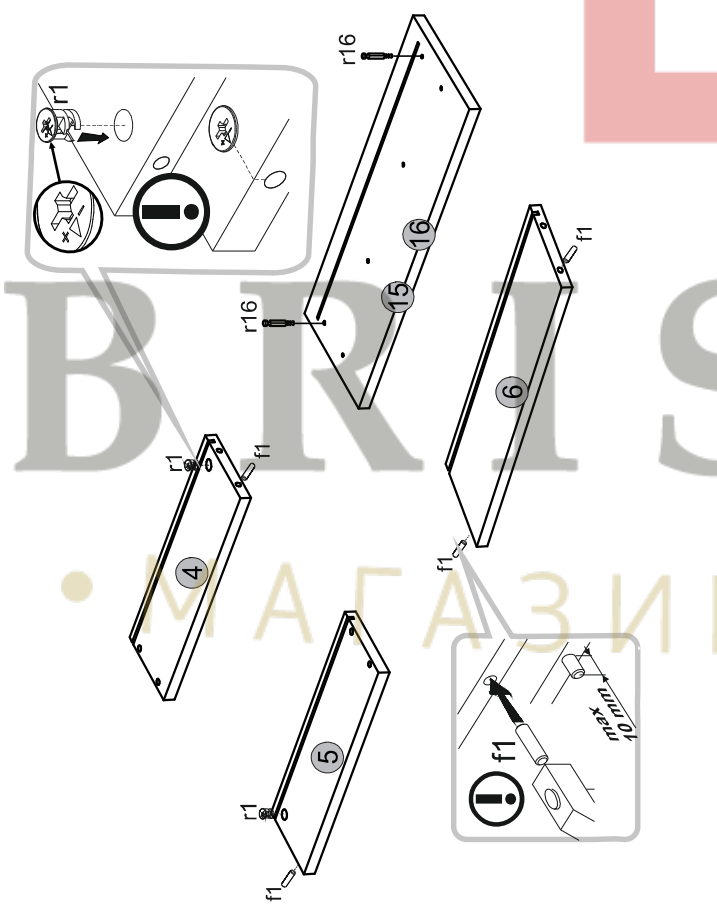

7

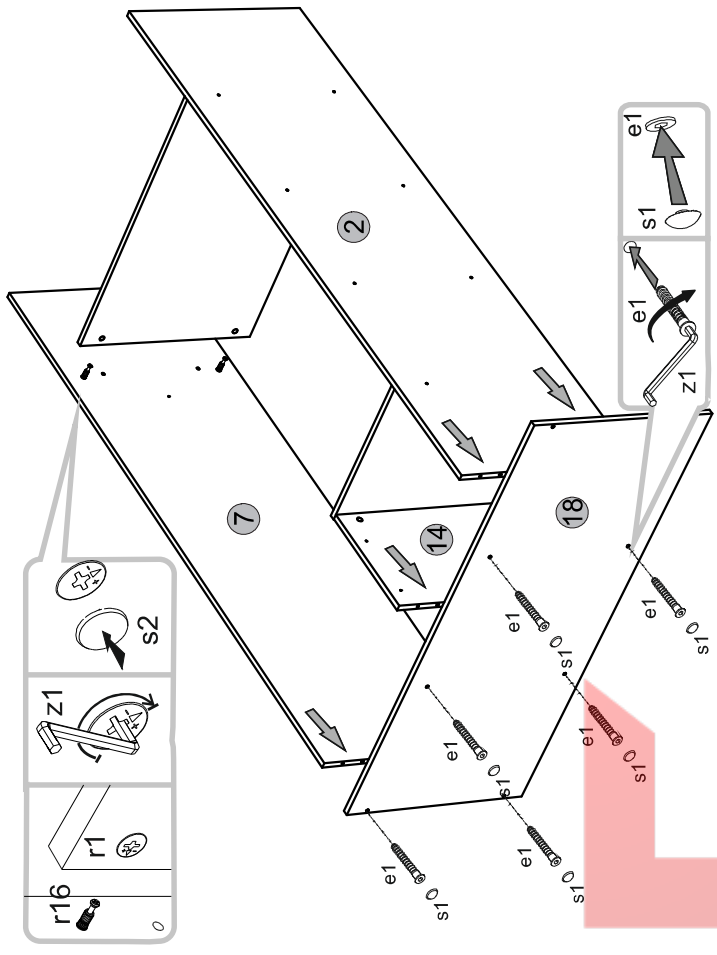

6

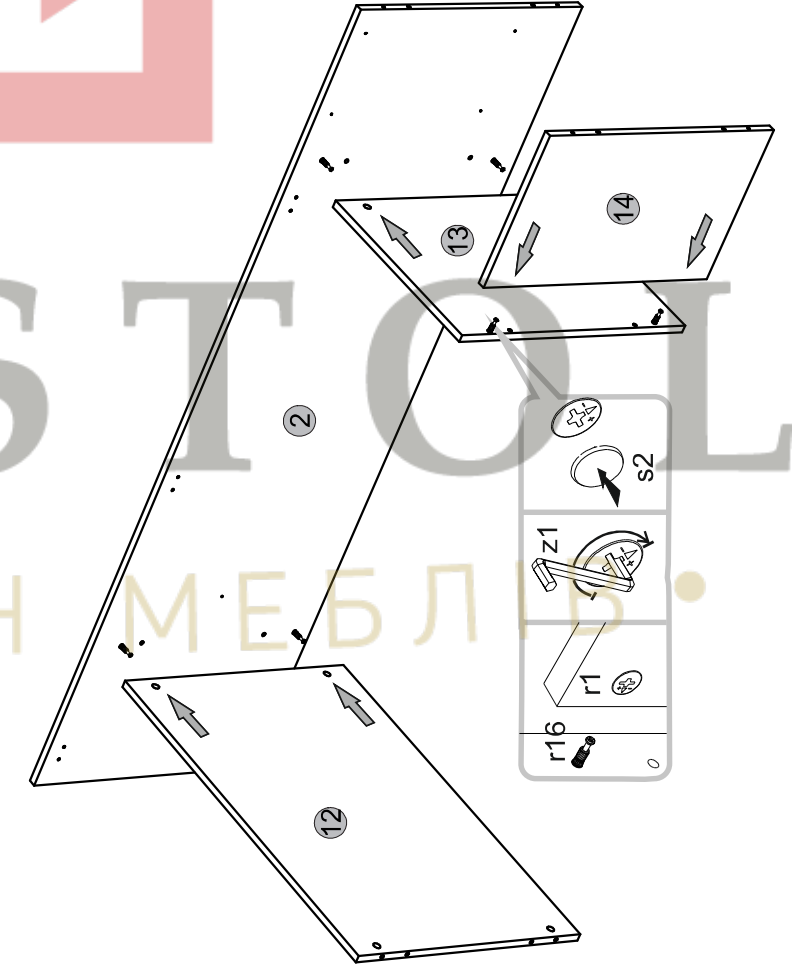

8

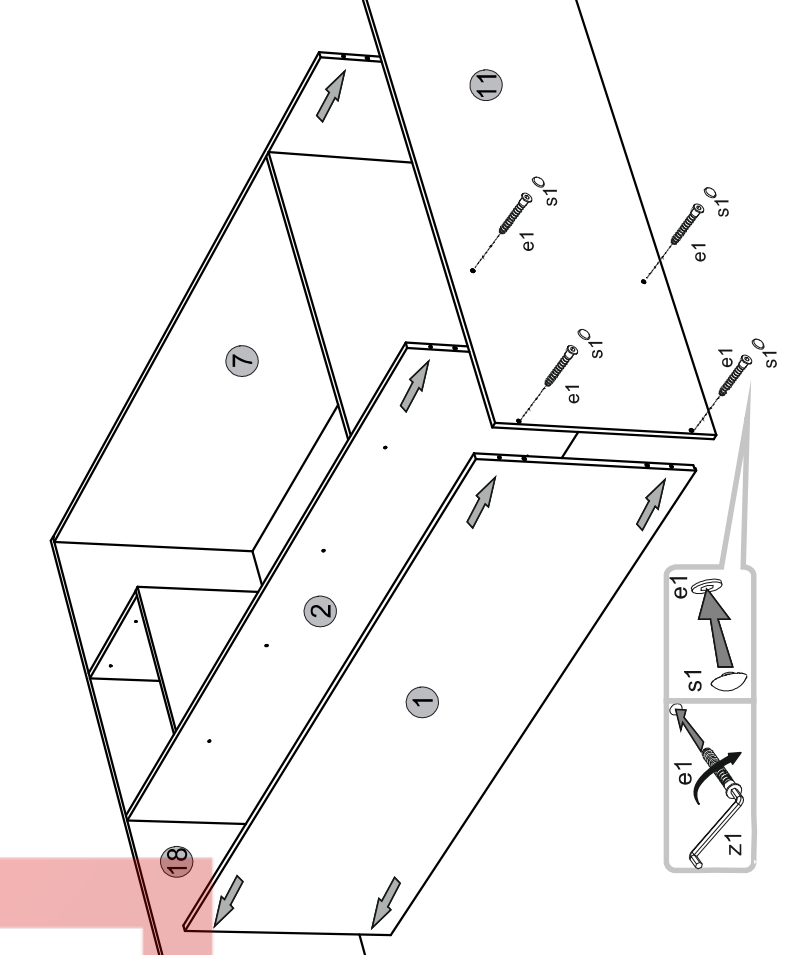

9



10

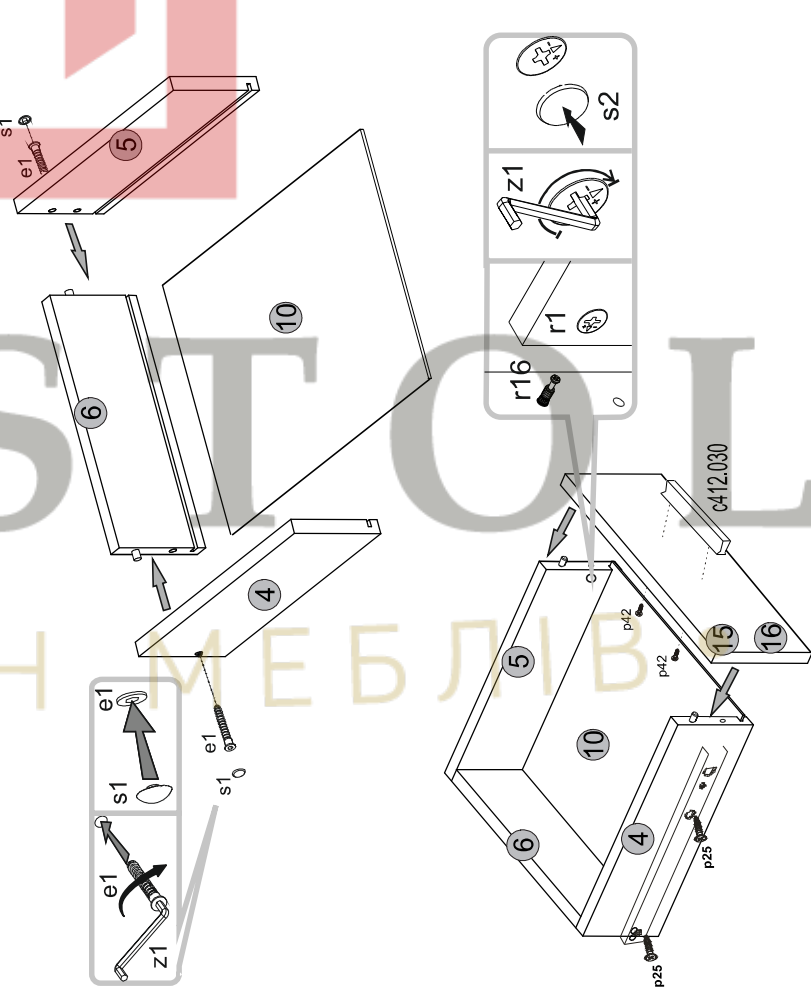

11

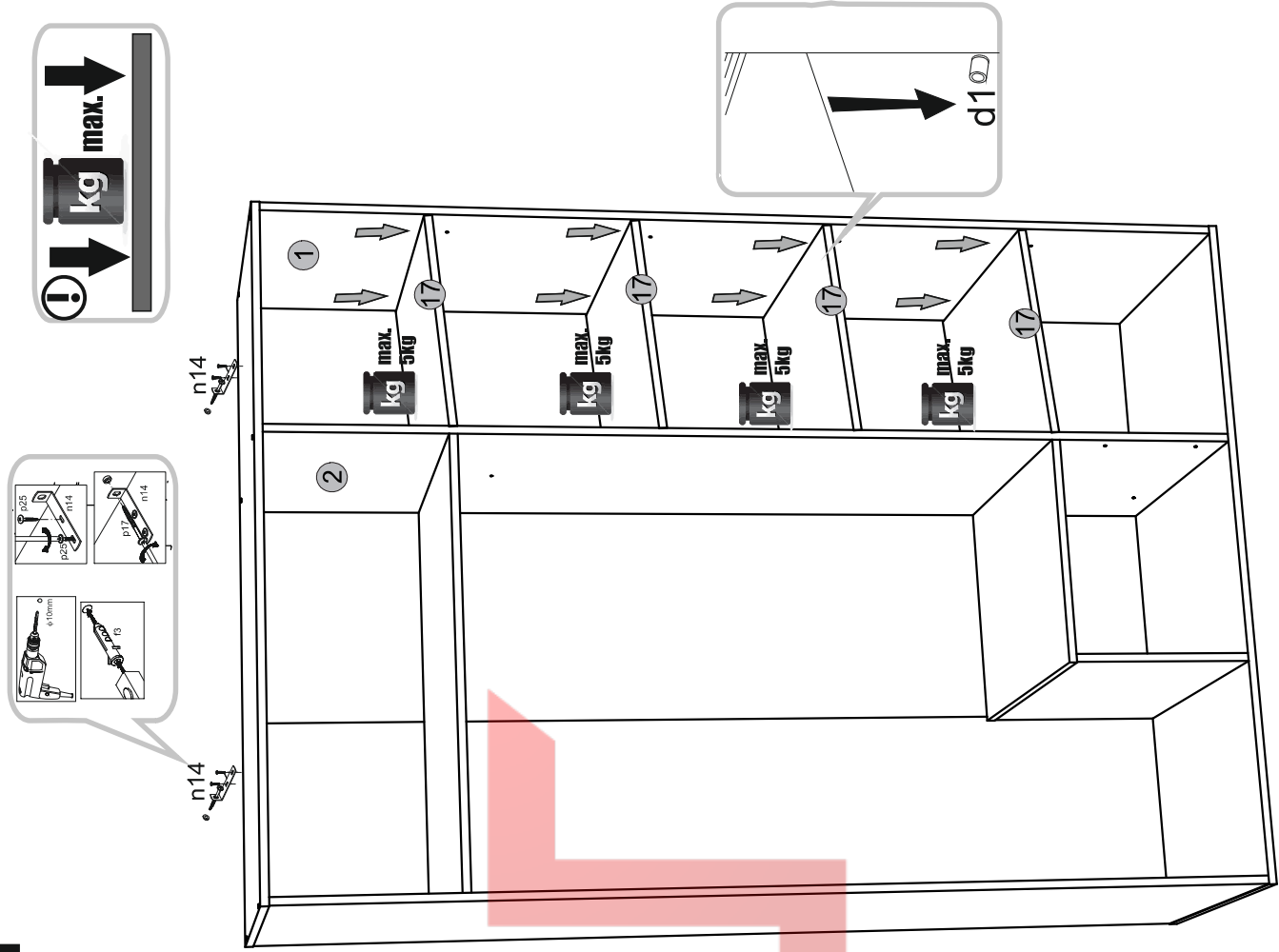

13

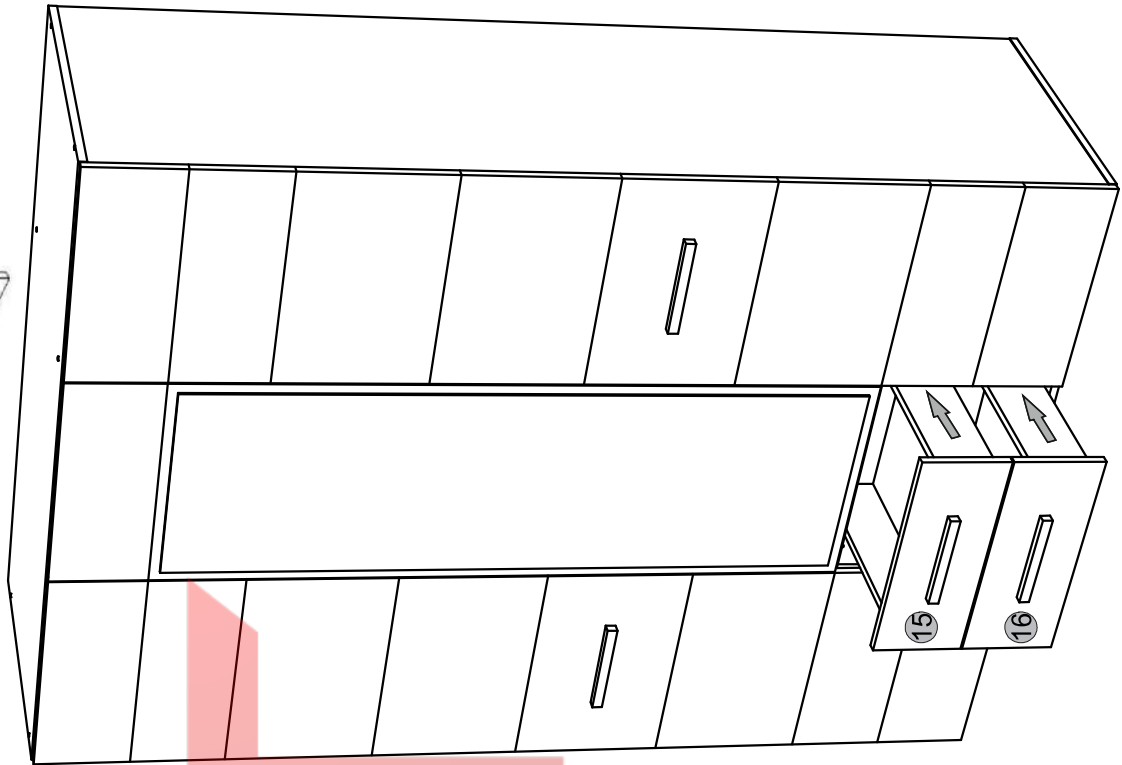
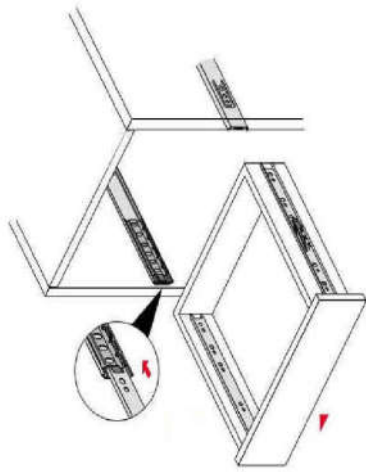

12

