

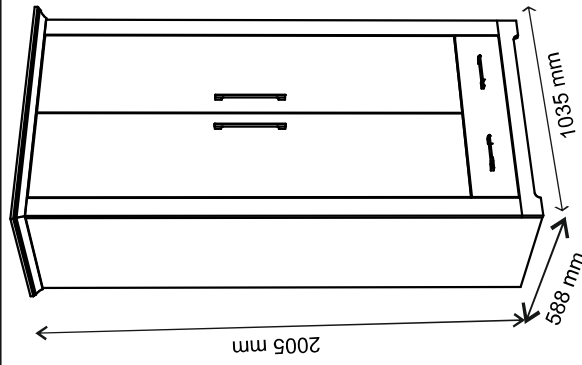

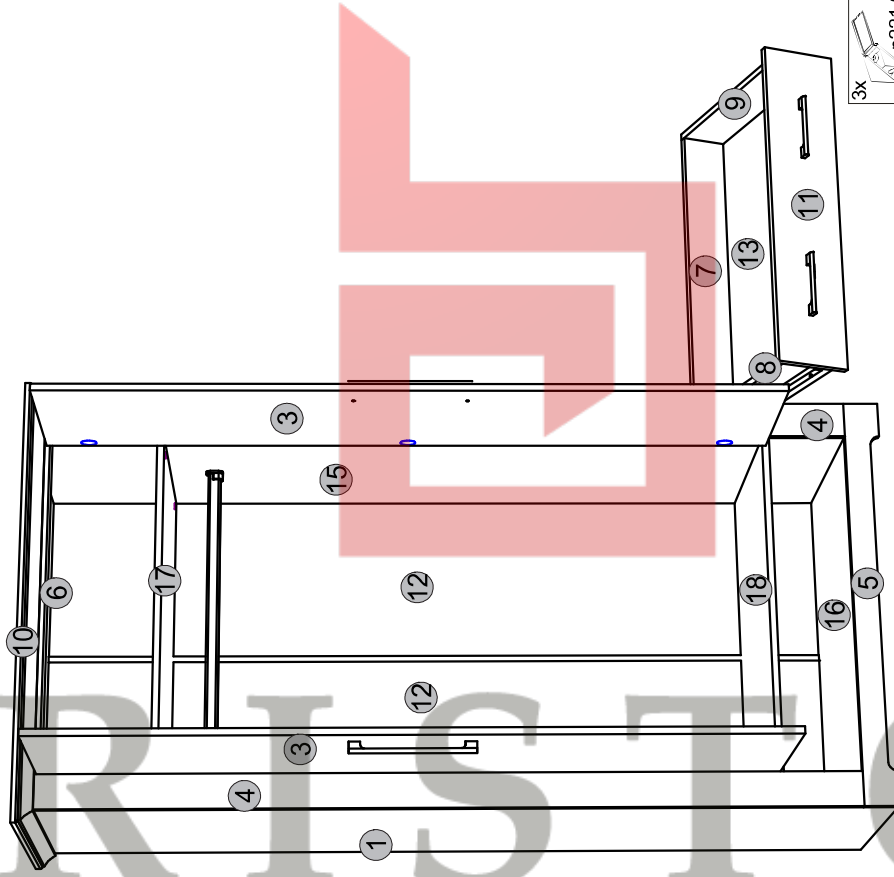

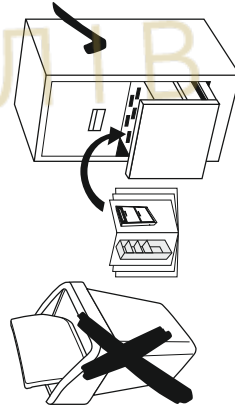

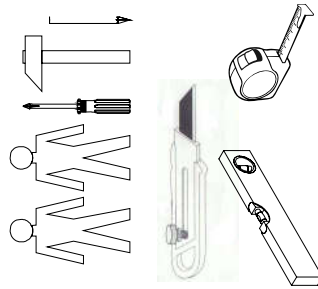

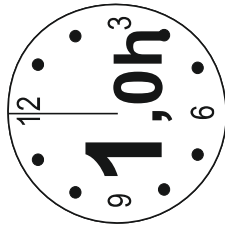
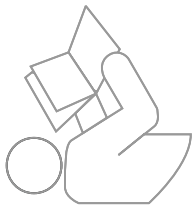







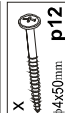

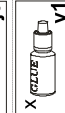

Instalation manual

ARSAL: Wardrobe 2D1S



Element symbol	Dimensions		Code	Package
1	1984	534	SZF_2D1S.001	1/1
2	1984	534	SZF_2D1S.002	1/1
3	1685	396	SZF_2D1S.005	2/2
4	1904	80	SZF_2D1S.010	1/1
5	961	80	SZF_2D1S.012	1/1
6	803	60	SZF_2D1S.013	1/1
7	745	130	SZF_2D1S.018	1/1
8	500	130	SZF_2D1S.019	1/1
9	500	130	SZF_2D1S.020	1/1
10	1035	588	SZF_2D1S.006	3/3
11	796	180	SZF_2D1S.017	1/1
12	1929	472	SZF_2D1S.015	1/1
13	763	502	SZF_2D1S.016	3/3
14	1904	531	SZF_2D1S.003	1/1
15	1904	531	SZF_2D1S.004	1/1
16	927	531	SZF_2D1S.007	3/3
17	803	531	SZF_2D1S.008	3/3
18	803	531	SZF_2D1S.009	3/3
19	60	484	SZF_2D1S.014	1/1

- 2x  n301
- 6x  b119
- 3x  n221.01
- 1x  n14
- 1x  f28
- 6x  a143
- 2x  24.19/28
- 1x  p12
- 8x  j8
- 1x  y1
- 16x  f11
- 11x  e1
- 15x  s1
- 11x  s2
- 15x  r1
- 15x  r16
- 38x  p25
- 45x  f1
- 45x  r16
- 6x  k1

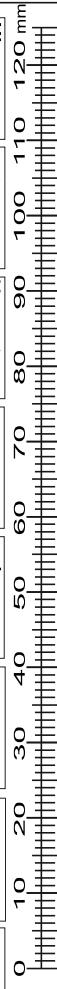

1

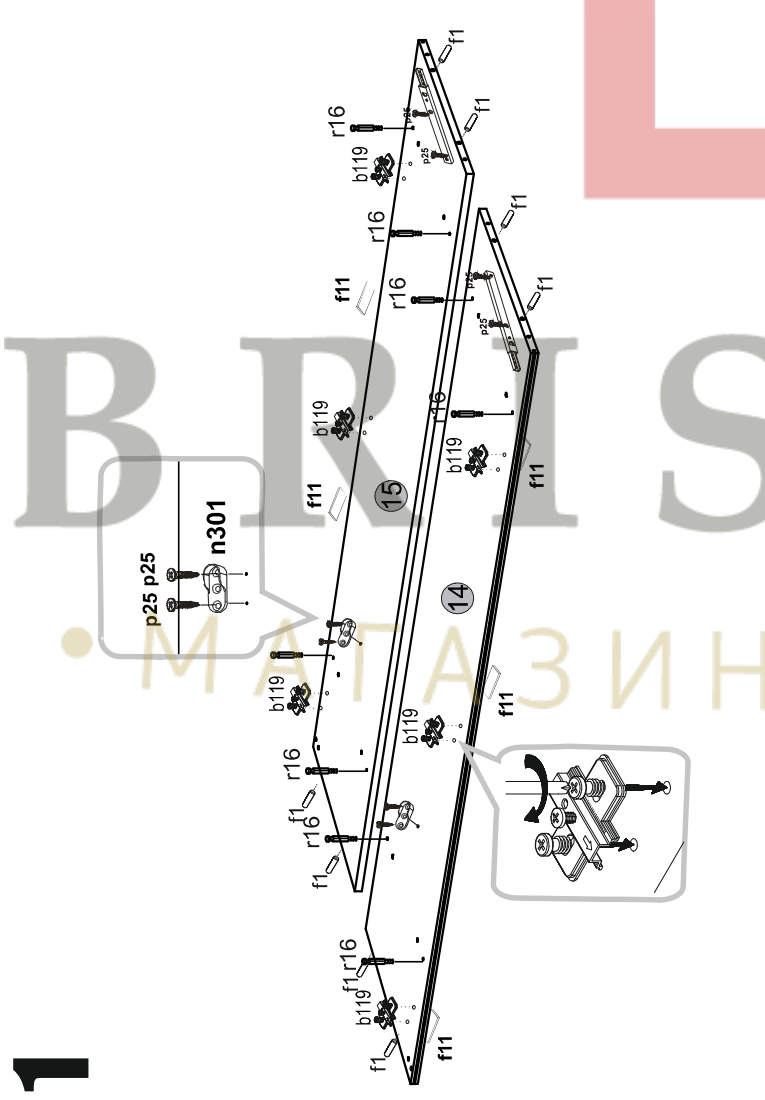

3

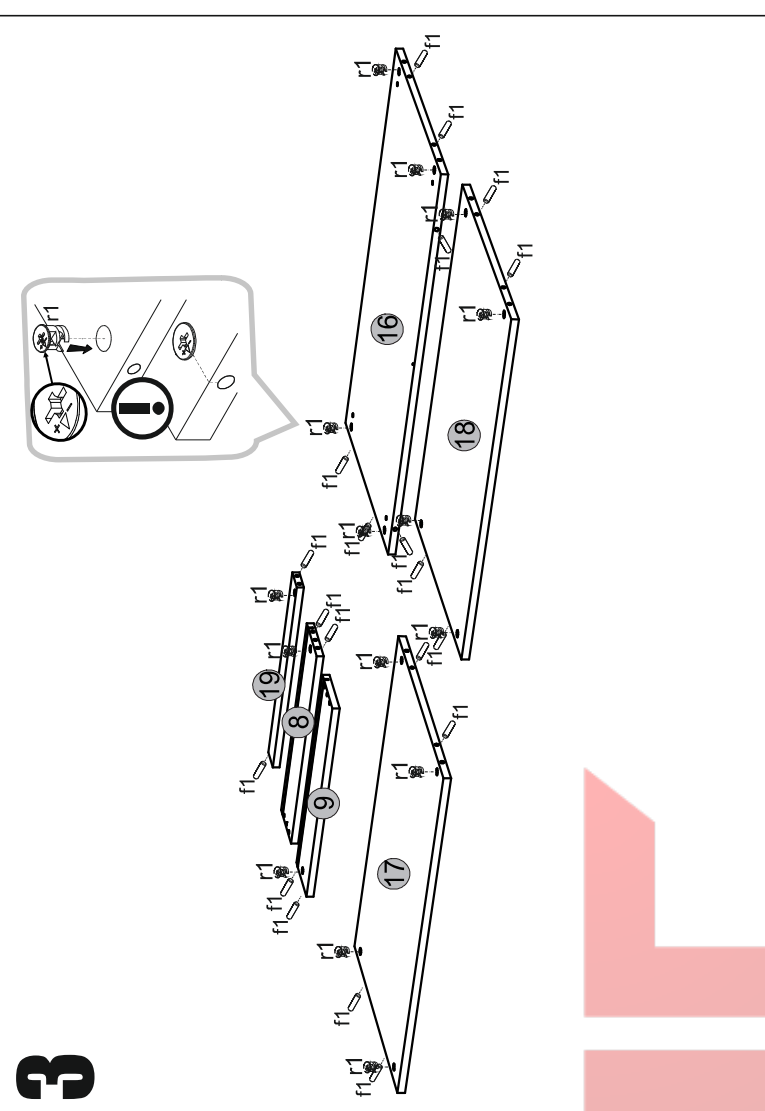

2

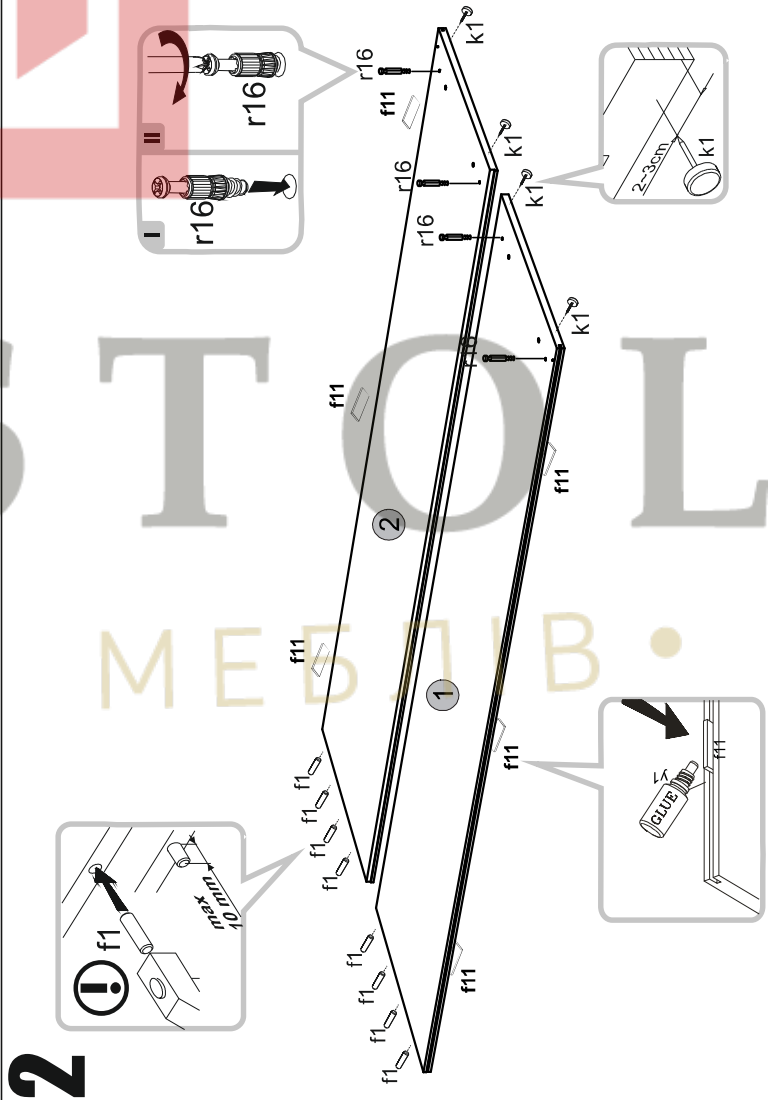

4

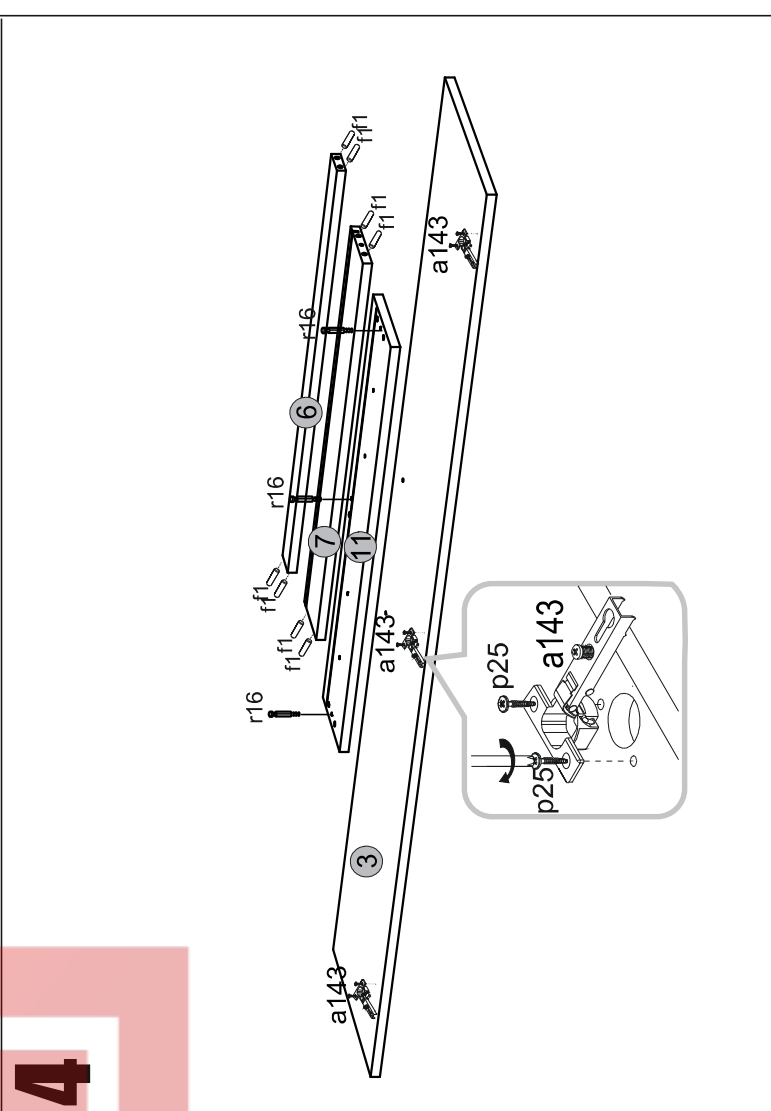

7

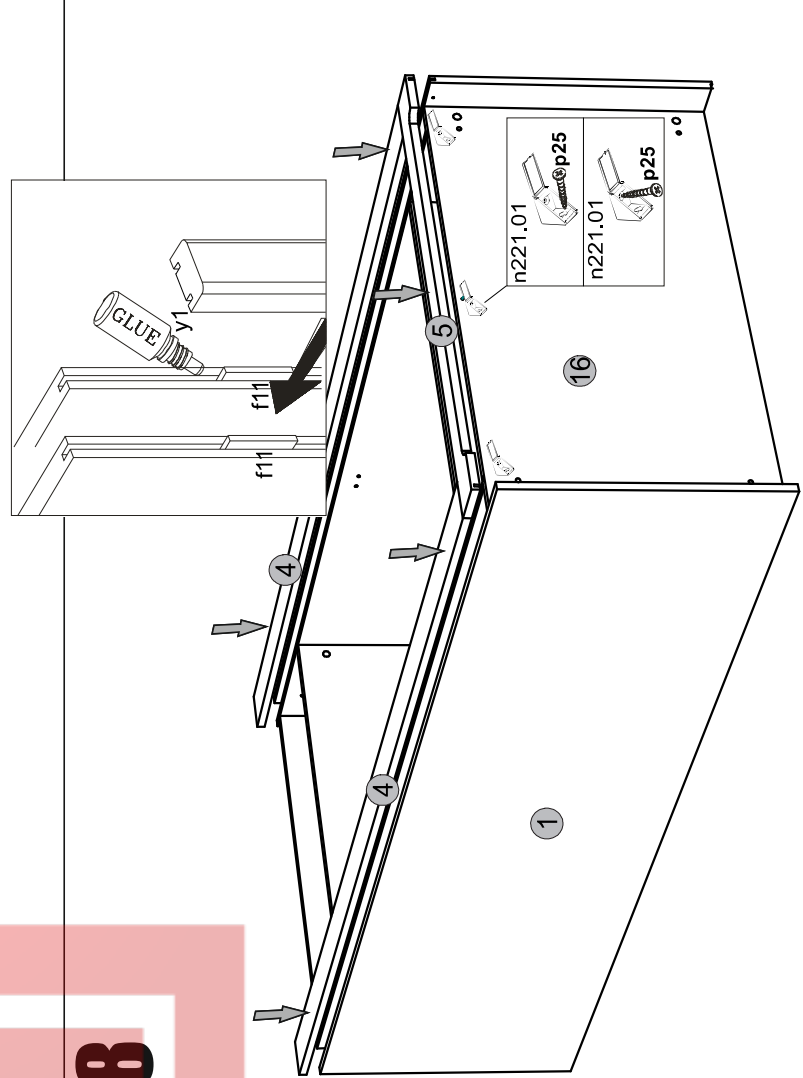
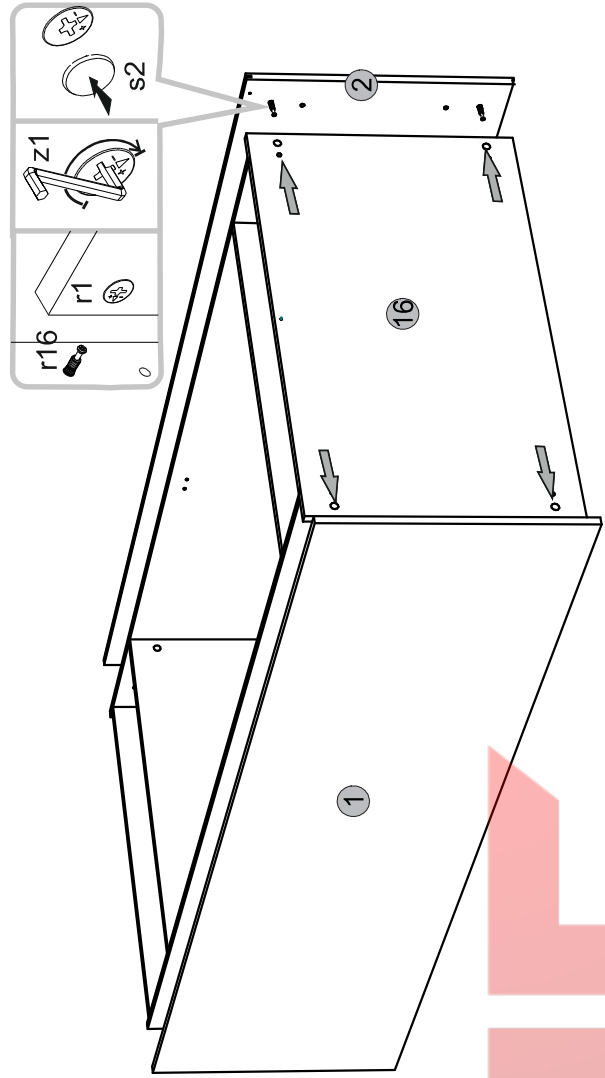

8

5

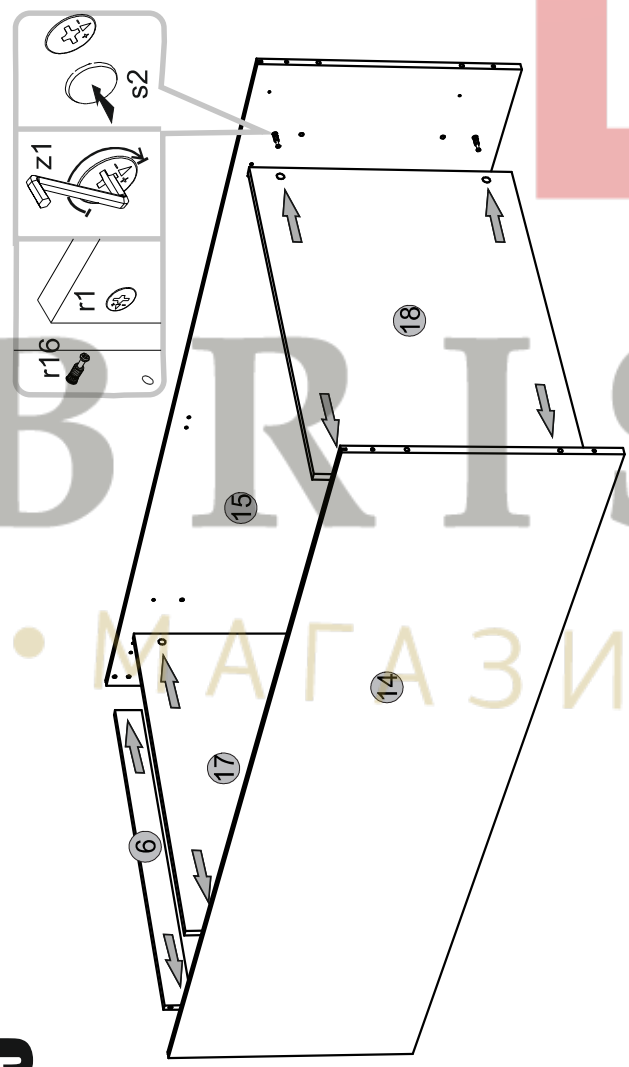

6

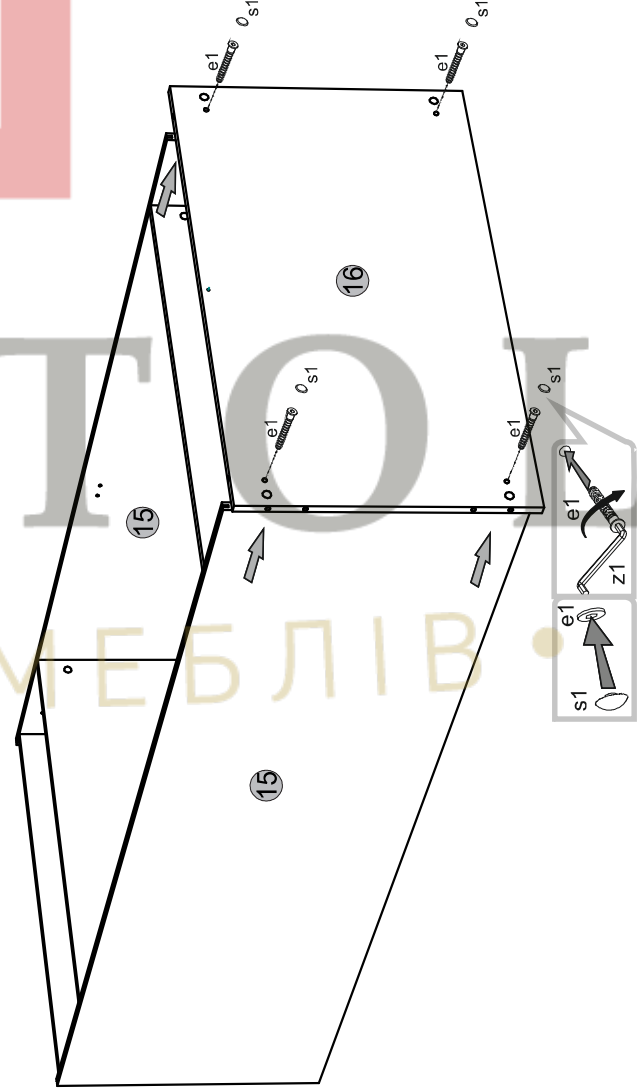

ВРІС ТО
 • МАГАЗИН МЕБЛІВ •

9

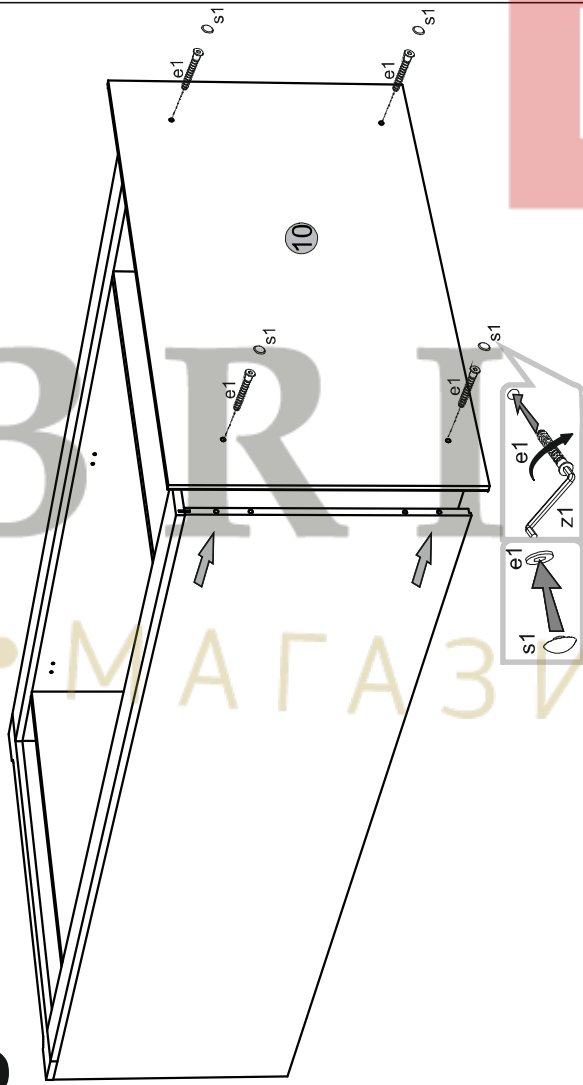

10

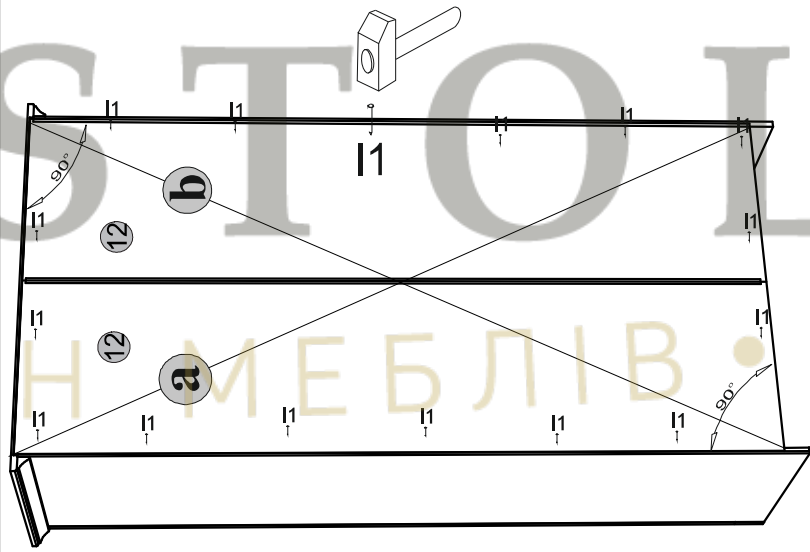

11

