

# Instalation manual

SOLO: POL\_180

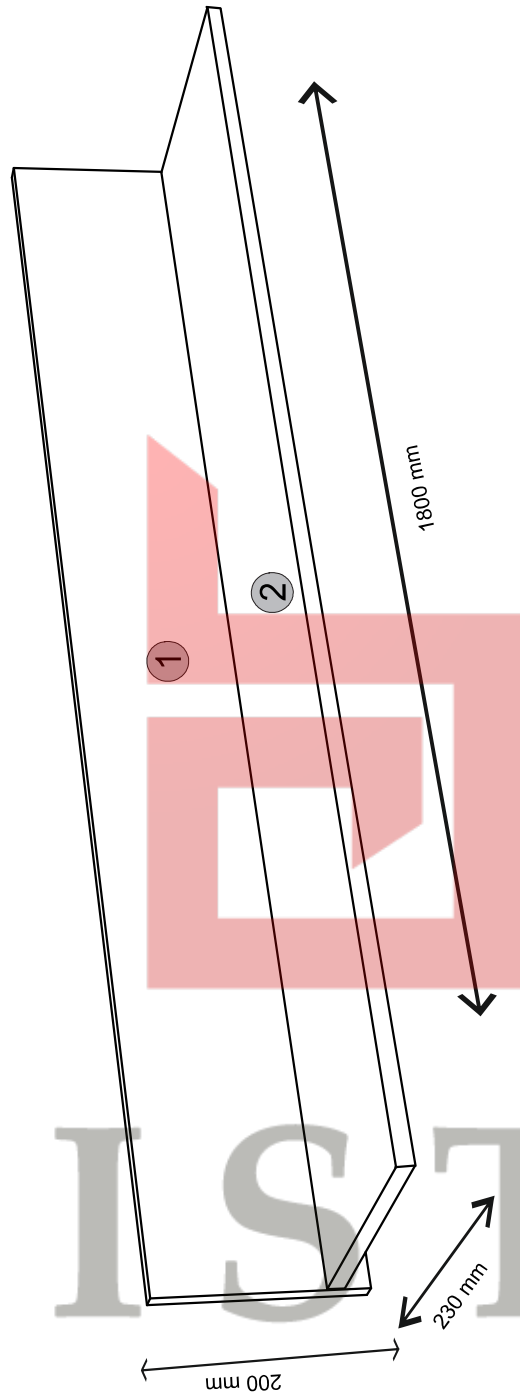
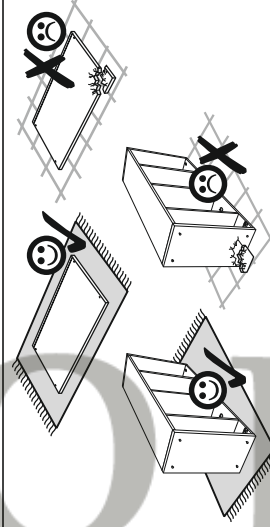
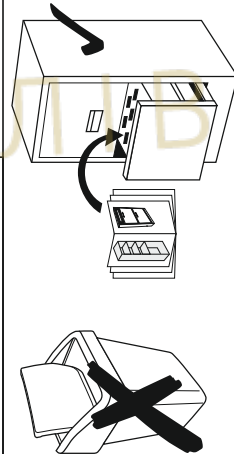
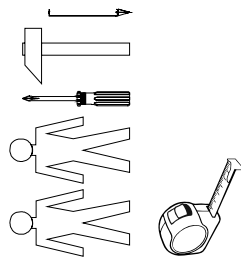
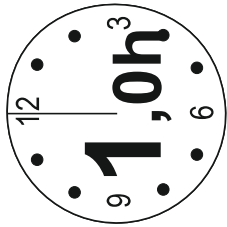
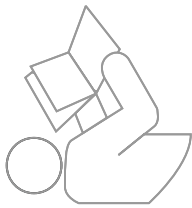

Element symbol	Dimensions	Code	Package
1	200 1800 16 1	POL180.002	1/1
2	1798 214 16 1	POL180.003	1/1

1x	z1	2x	g2	6x	f1	2x	e3
5x	e1	2x	p17	4x	e19	2x	f3
5x	s1						

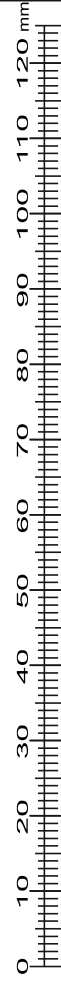

1

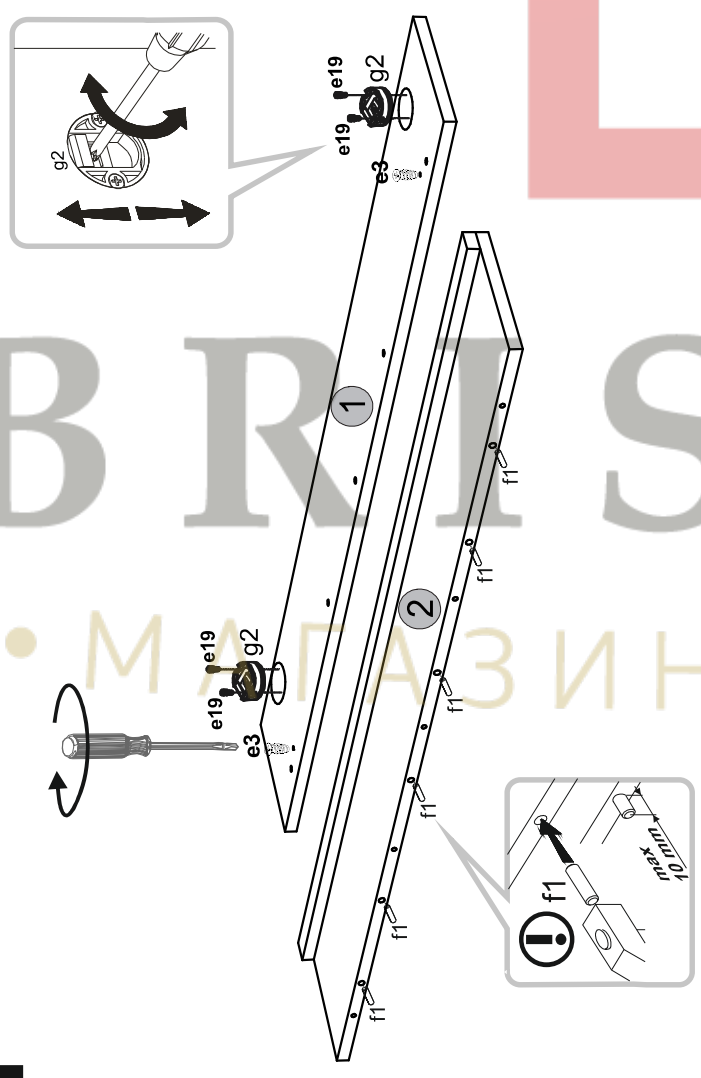

2

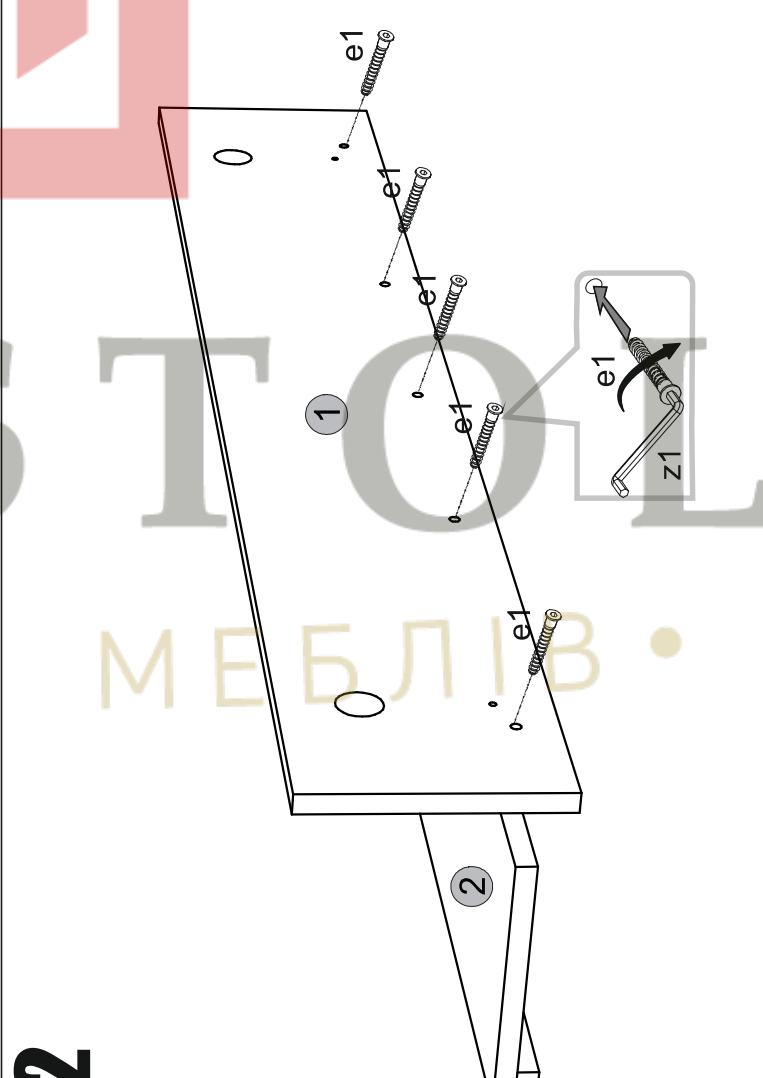

3

