

# DOORS

HSU3D 22/17

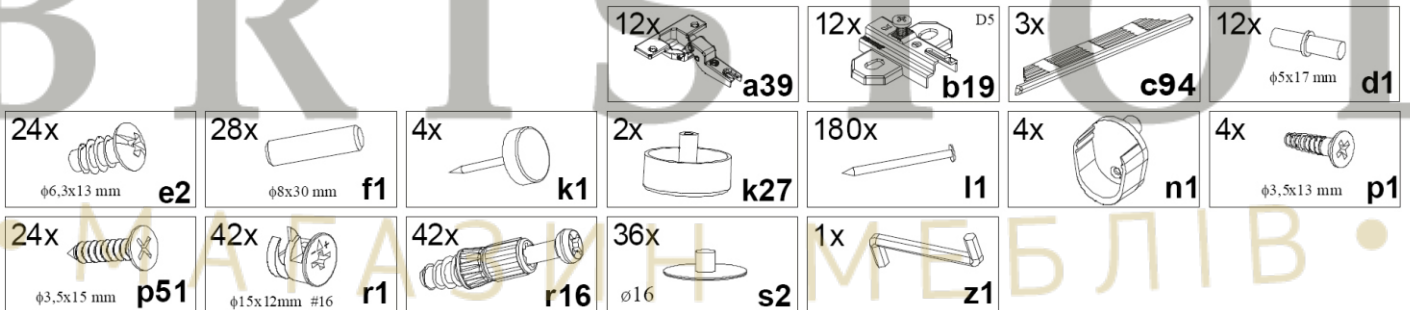

A	C	B	D
1	2164x520	S33-001	5/6,6 /6
2	2188x536	S33-1101	1/6
3	2188x536	S33-1102	1/6
4	2156x536	S33-103	2/6
5	2156x536	S33-104	2/6
6	1674x536	S33-2201	3/6
7	546x475	S33-301	3/6
8	516x535	S33-302	4/6
9	1640x536	S33-314	3/6
10	516x535	S33-318	4/6
11	2197x564	S33-980	1/6
12	2197x532	S33-902	1/6
13	2197x564	S33-980	1/6
14	539x24	dr-539	3/6

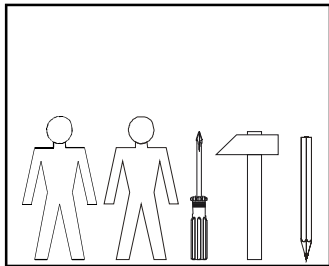
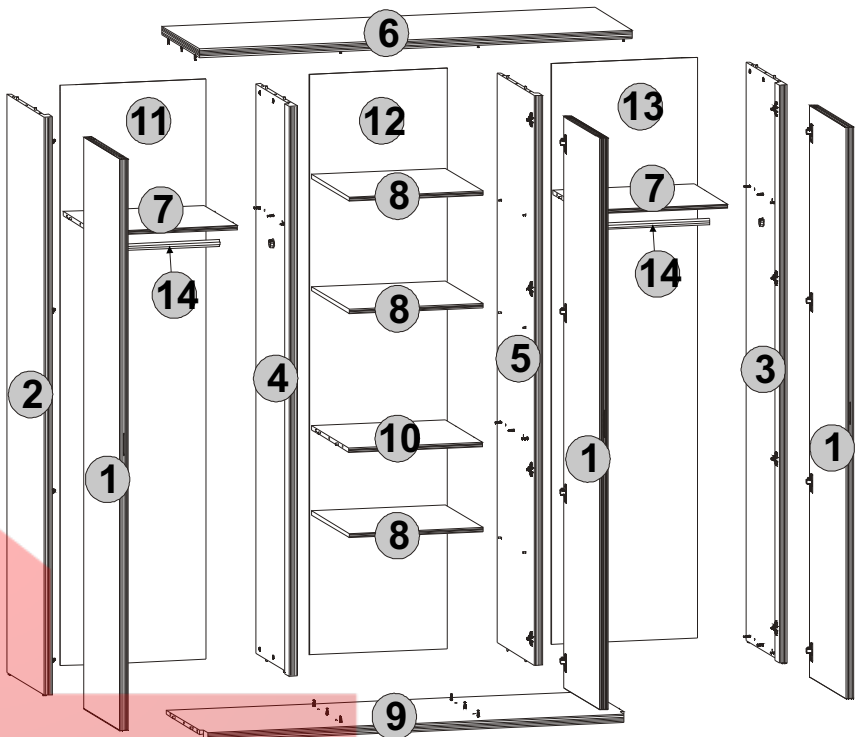

1

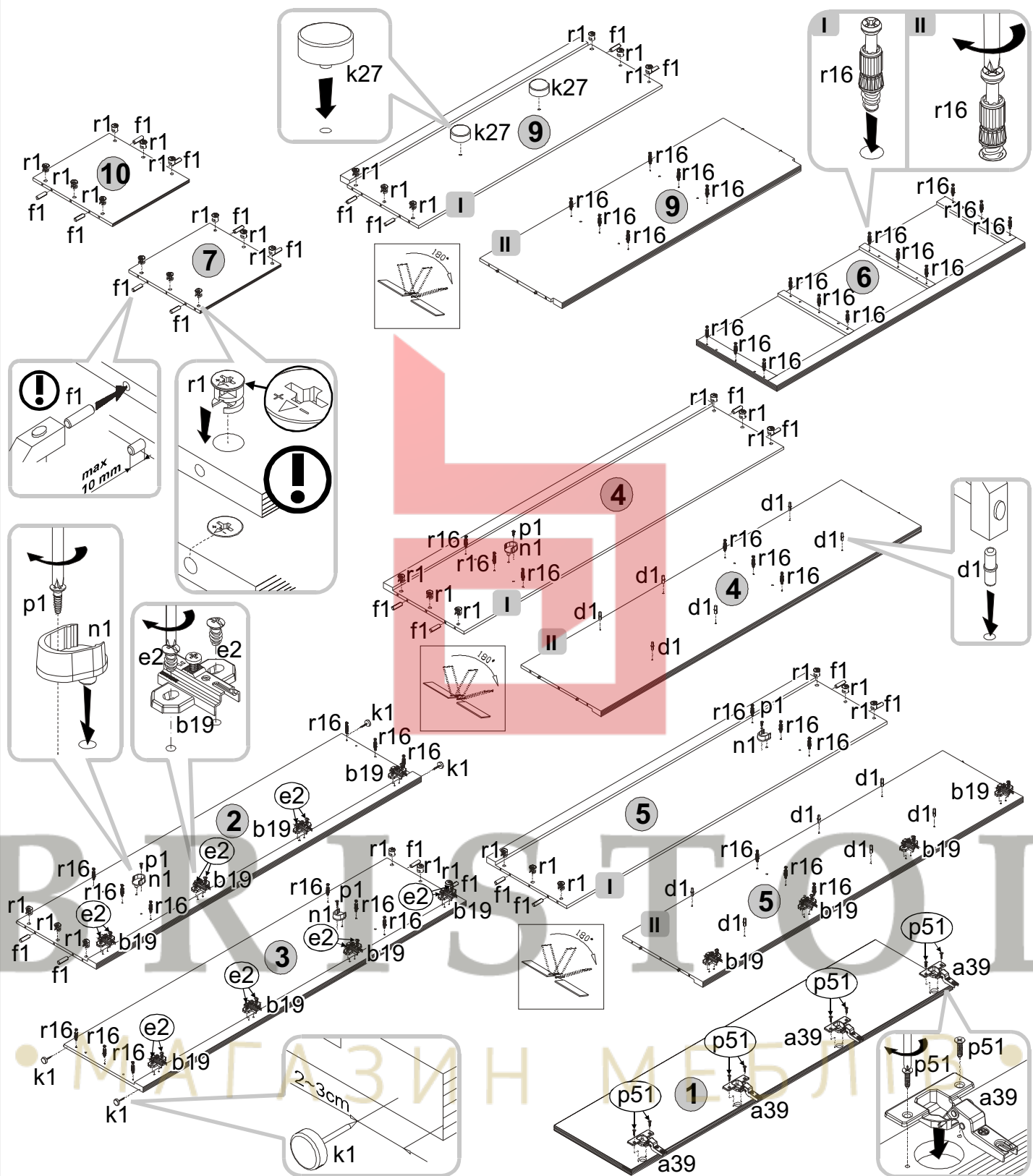

# 2

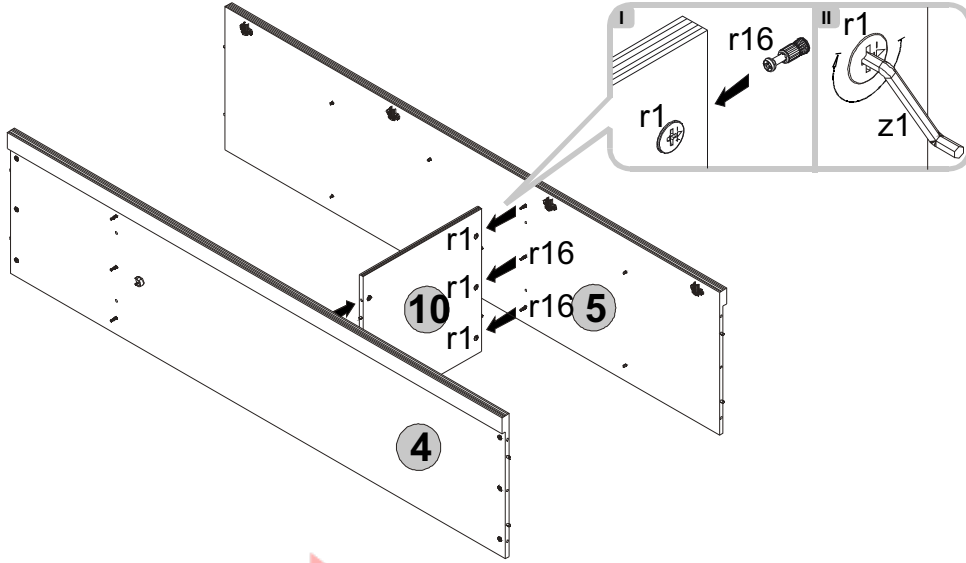

# 3

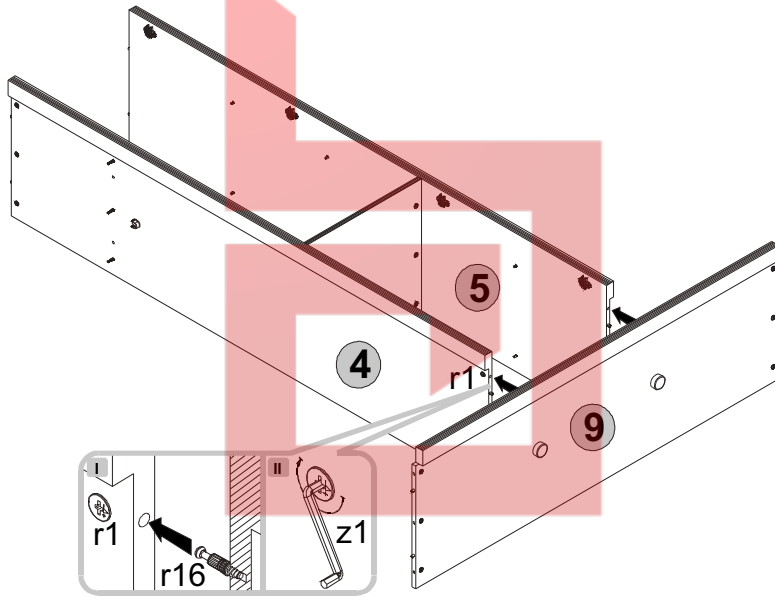

# 4

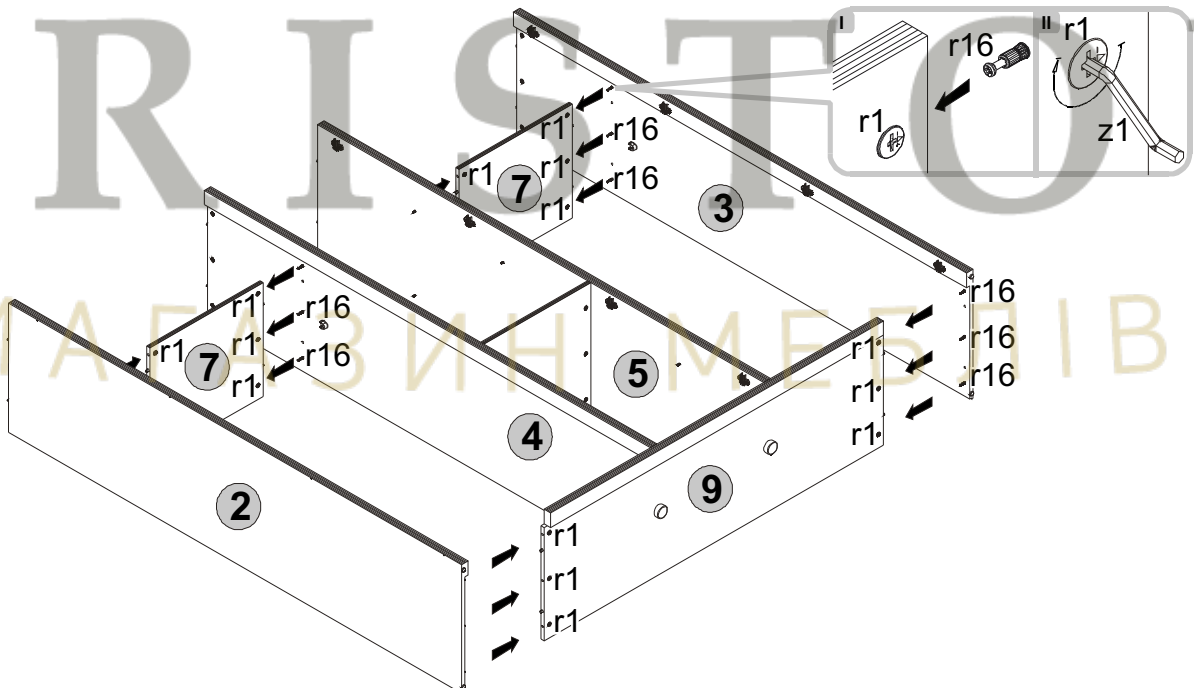

5

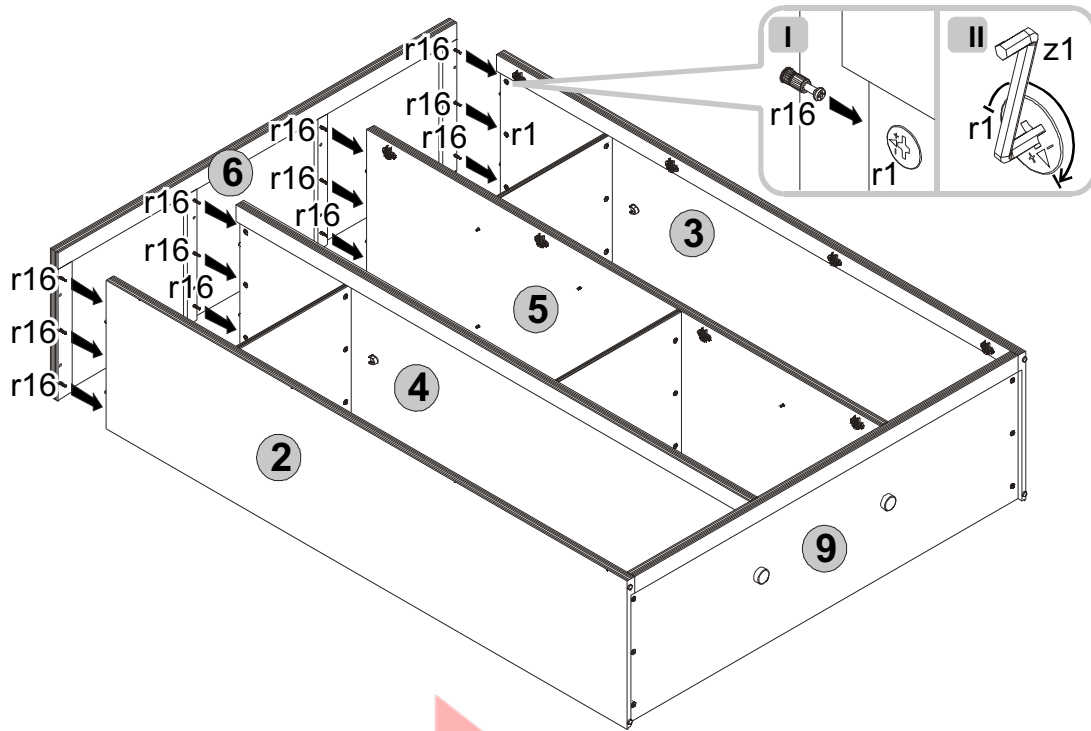

6

! a=b

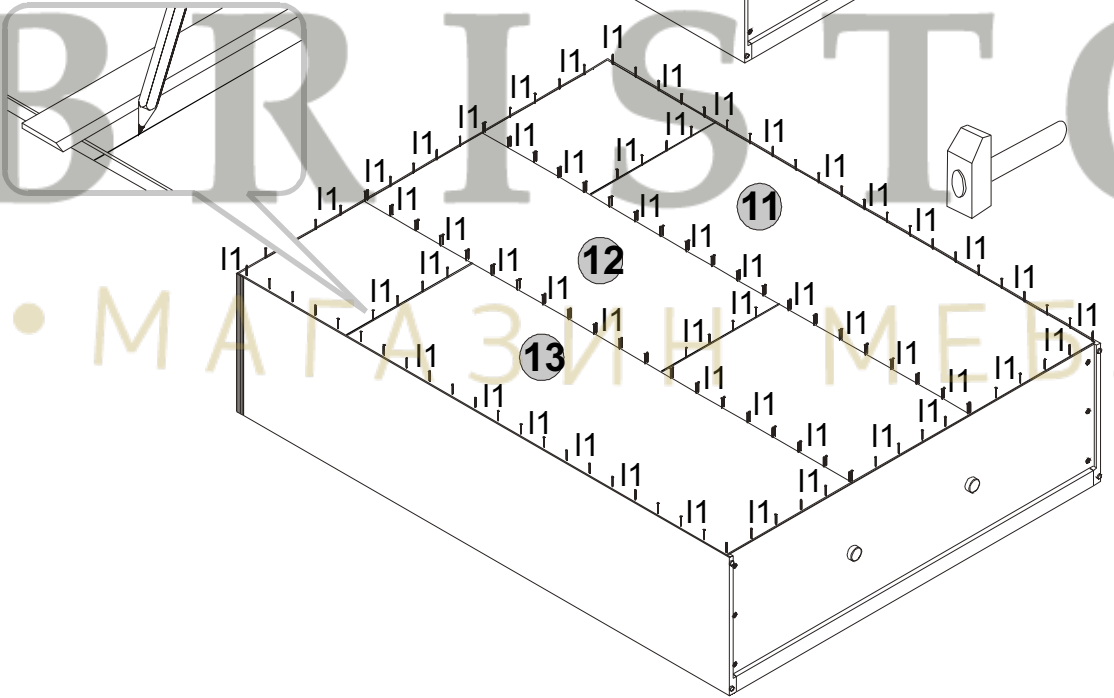
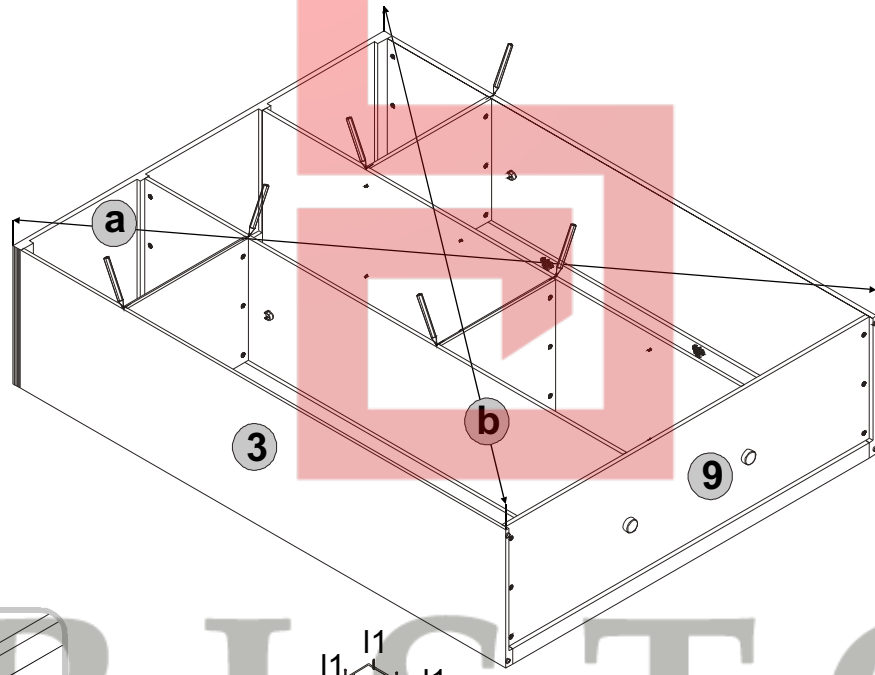

7

