

A	B	C	D
1	GR1-309	900	227
2	GR1-401	900	160

ДСП

3	GR1-402	900	80	1/1
---	---------	-----	----	-----

МДФ

3	GR1-403	900	80	1/1
---	---------	-----	----	-----

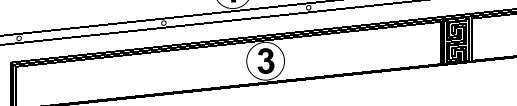
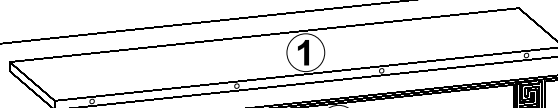
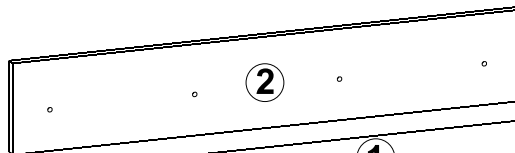
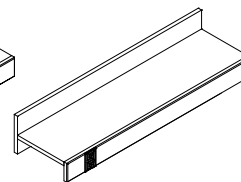
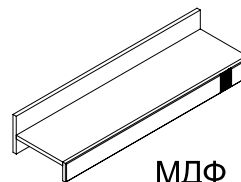
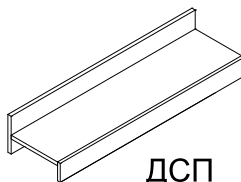
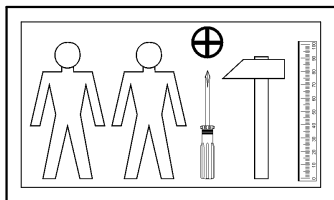

МДФ

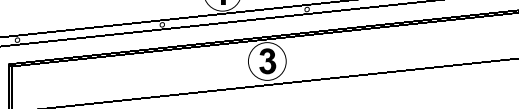
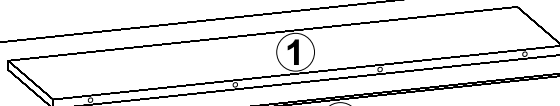
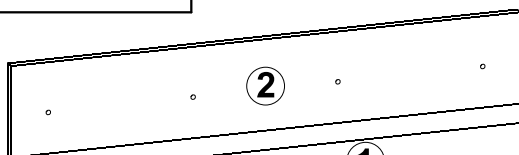

ДСП

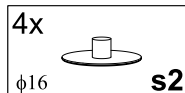
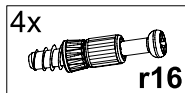
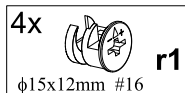
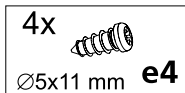
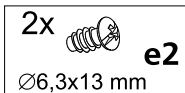
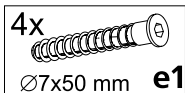

1 §2

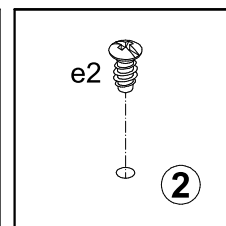
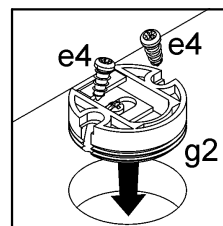
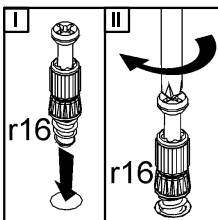
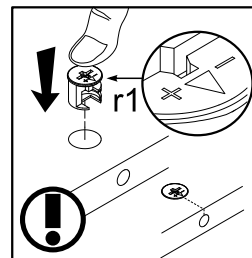
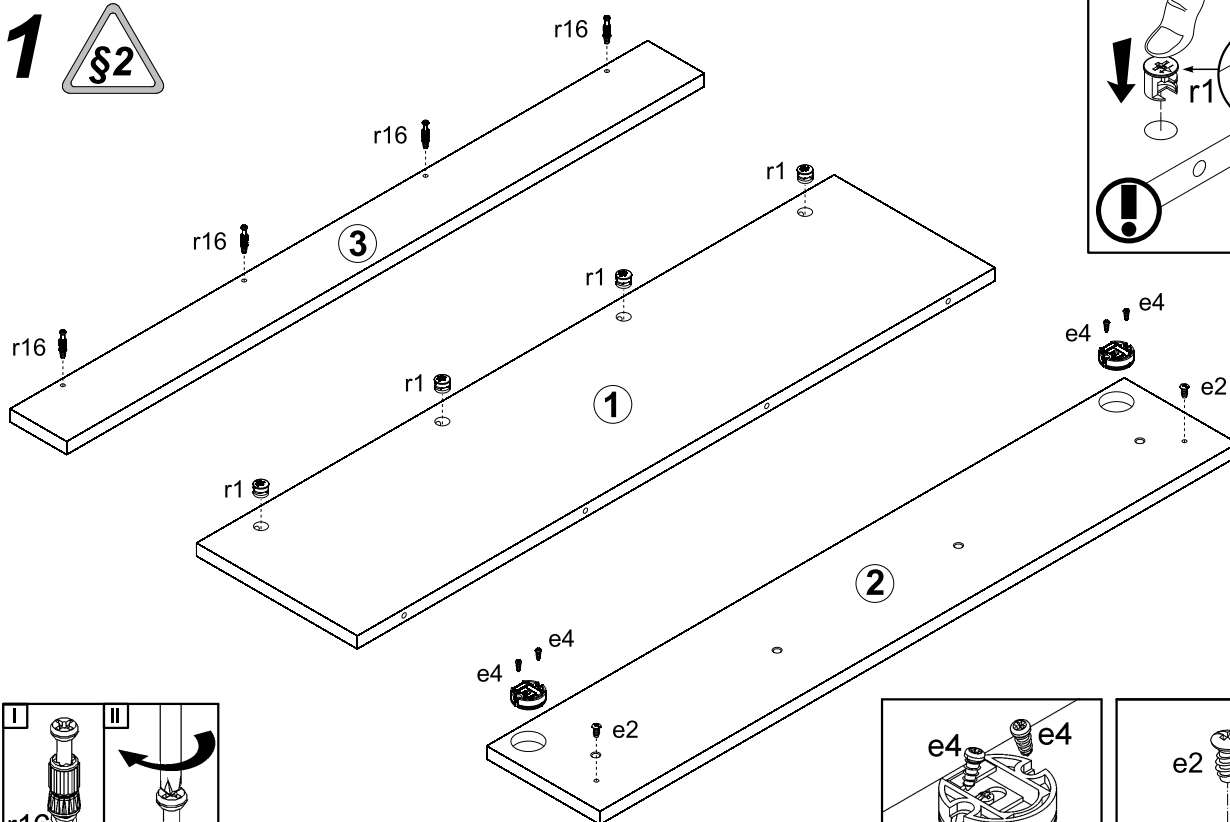

2

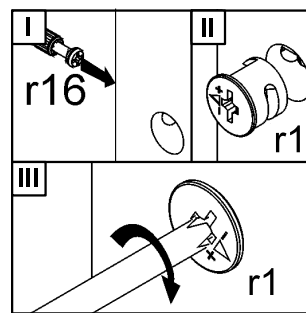
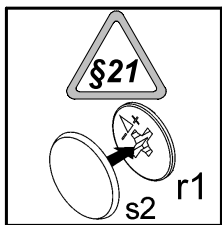
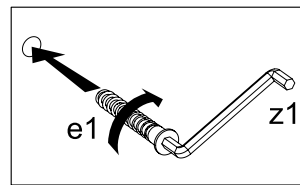
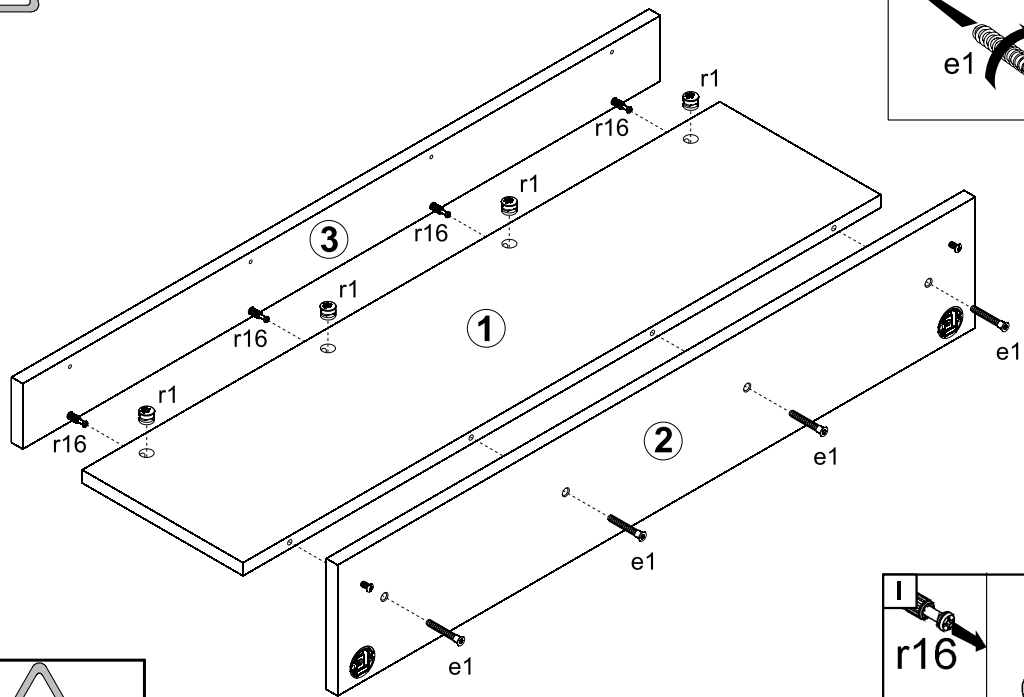

3

