

# POP

## S05-kw3so/11/11, S05-kd3so/11/11

A	B	C	D	
1	SK1-013	348	150	4/4
2	SK1-016	1023	348	3/4
3	SK1-130	1105	325	1/4
4	SK1-131	1105	325	1/4
5	SK1-132	1029	300	1/4
6	SK1-133	1029	300	1/4
7	SK1-210	1094	330	2/4
8	SK1-326	1056	321	1/4
9	SK1-327	352	280	2/4
10	SK1-328	335	290	2/4
11	SK1-405	1056	60	2/4
12	SK1-511	865	120	2/4
13	SK1-908	331	260	2/4
14	SK1-943	1065	368	2/4
15	SK1-944	1065	360	2/4
16	SK1-023/A	1023	348	3/4
17	SK1-024/A	1023	348	3/4

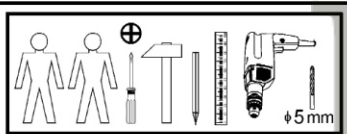
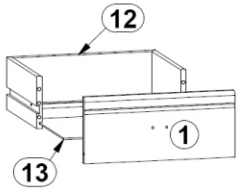
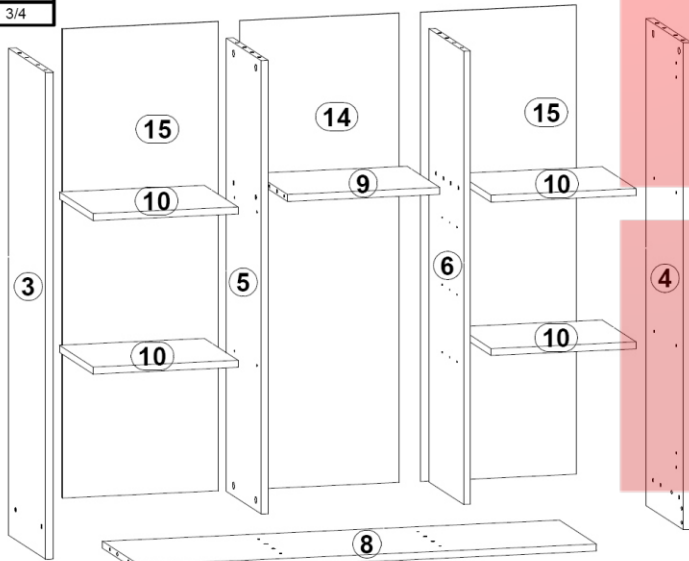

4x a1	4x b1	5x c12	16x d1 øx17 mm	8x e1 ø7x20 mm	43x f1 øx20 mm	6x j2 34xø mm	4x k1	100x l1
18x p1 ø3,5x13 mm	10x p8 øx25 mm	12x r1 ø1,5x17mm -16	12x r16	8x s1	12x s2 ø16	4x s4 ø5	6x w1 185 mm	1x y1 GLUE
1x z1	1x n26/1	1x p38 ø3,5x16 mm						

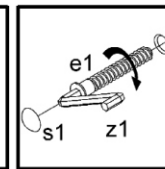
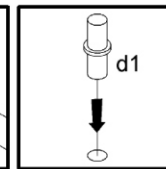
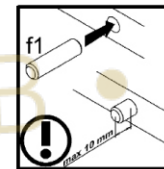
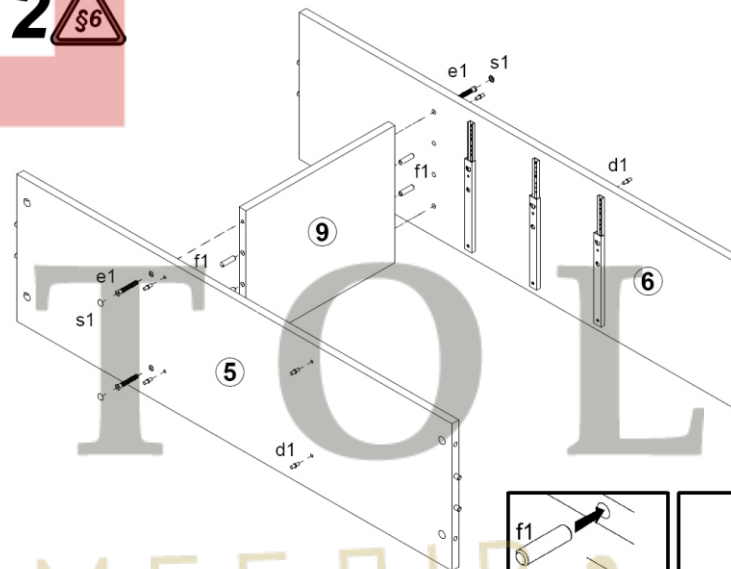
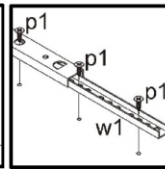
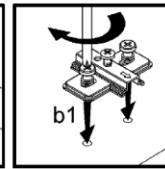
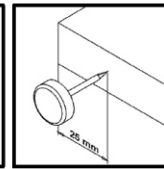
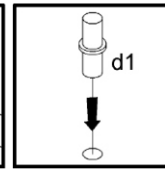
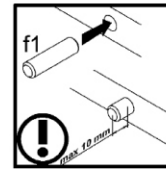
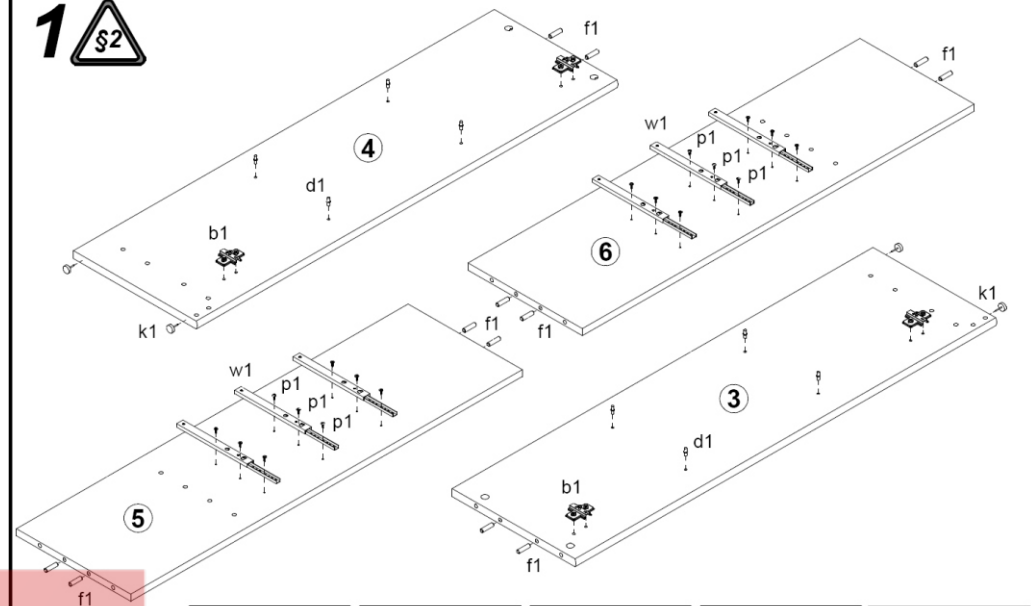

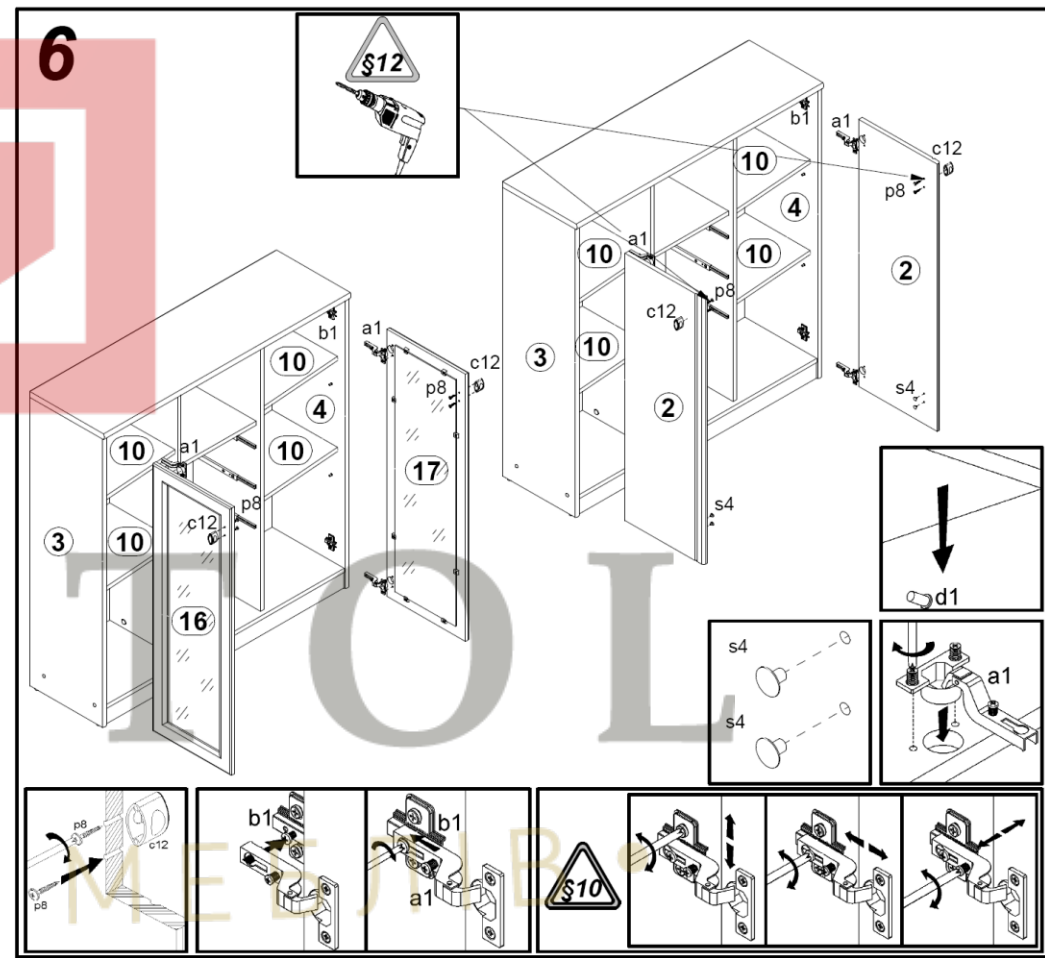
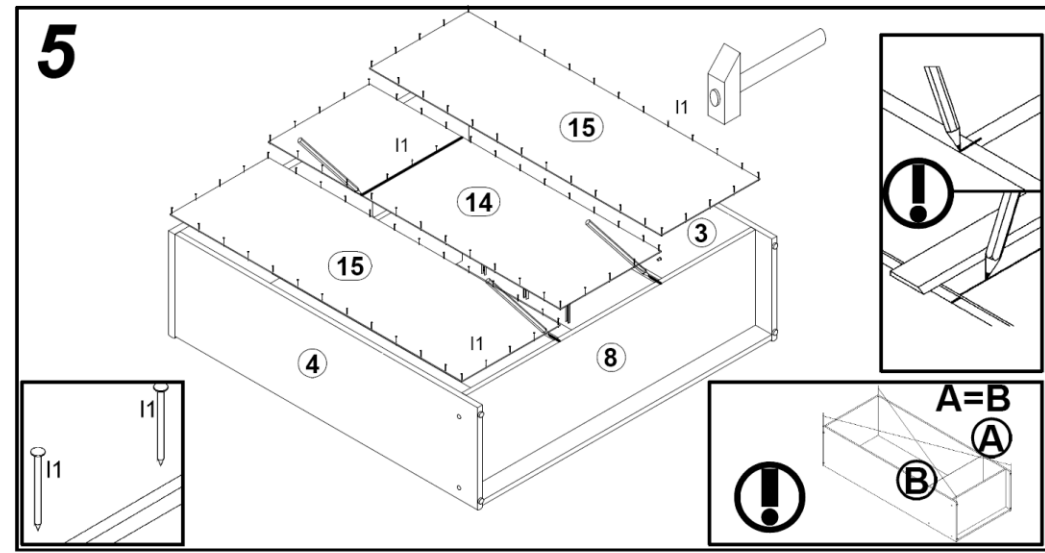
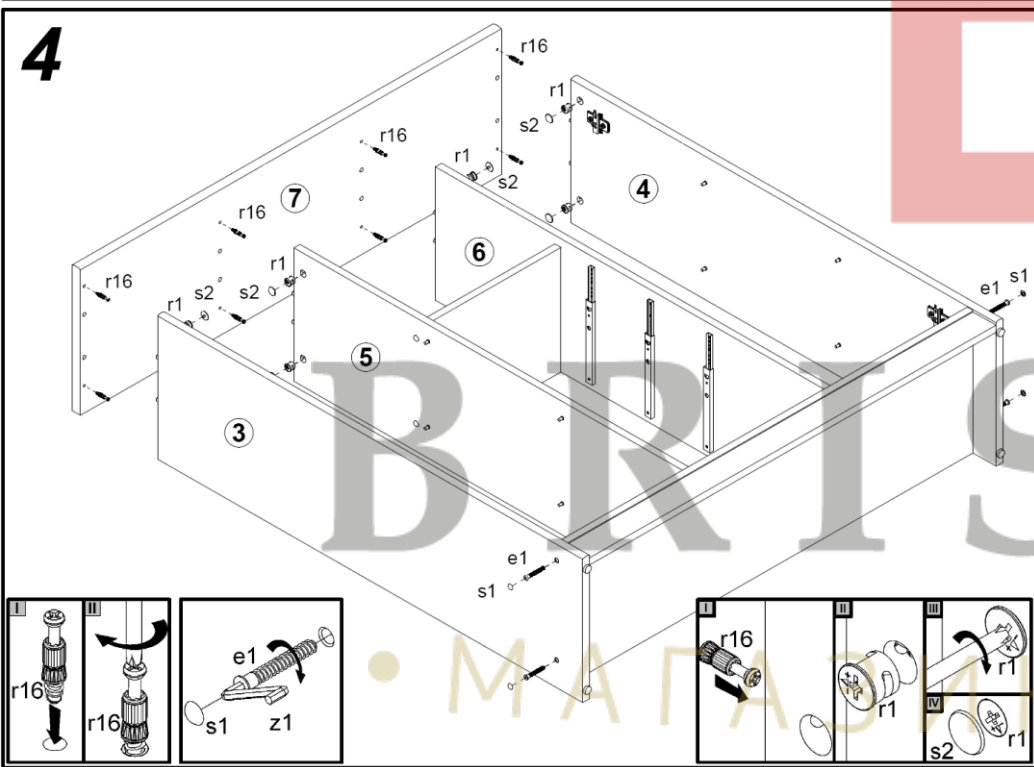
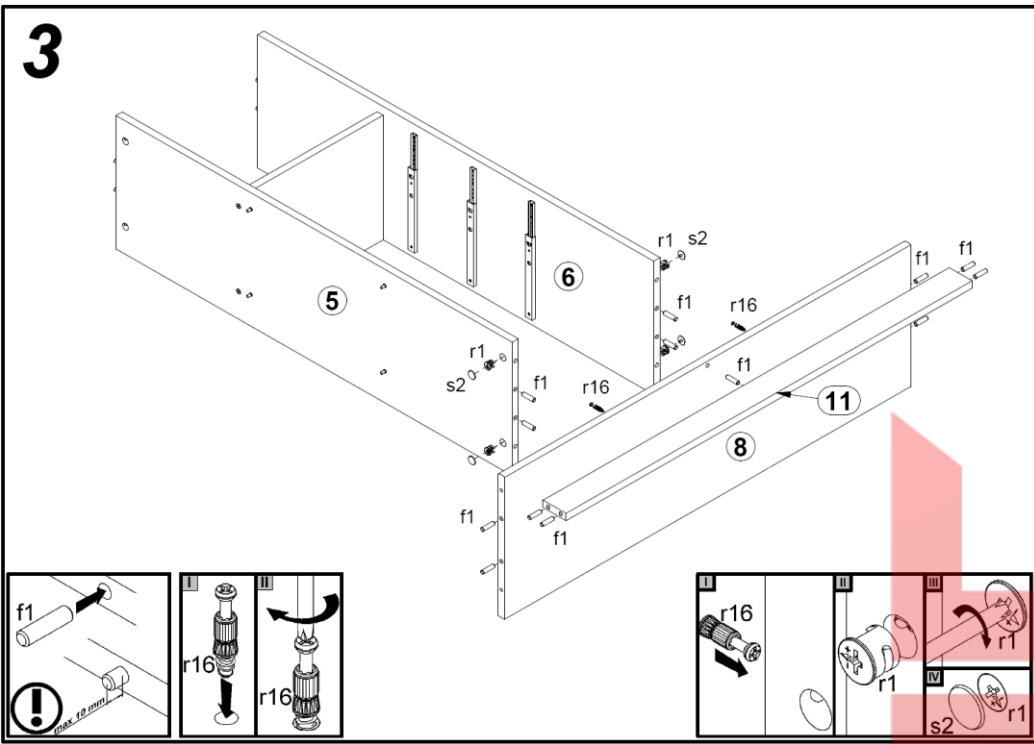

7

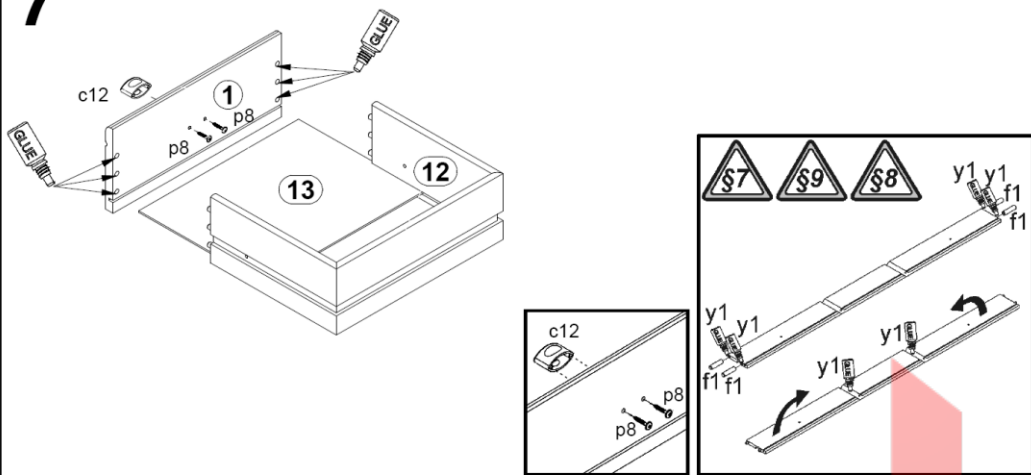

8

