

RAFLO

S126-KOM2W4S/10/16

A	B	C	D	A	B	C	D		
1	S126-148	906	409	2/3	15	S126-514	477	106	2/3
2	S126-149	906	409	2/3	16	S126-555	329	435	2/3
3	S126-211	1600	451	1/3	17	S126-584	220	80	2/3
4	S126-320	1567	409	1/3	18	S126-585	365	80	2/3
5	S126-324	509	409	1/3	19	S126-709	203	429	2/3
6	S126-325	509	409	1/3	20	S126-710	203	429	2/3
7	S126-326	509	409	1/3	21	S126-711	364	429	2/3
8	S126-327	509	409	2/3	22	S126-712	364	429	2/3
9	S126-453	522	475	3/3	23	S126-713	375	130	2/3
10	S126-508	350	120	2/3	24	S126-914	487	356	1/3
11	S126-509	350	120	2/3	25	S126-915	522	158	1/3
12	S126-511	350	200	2/3	26	S126-916	522	291	1/3
13	S126-512	350	200	2/3	27	S126-9910	924	533	1/3
14	S126-513	477	186	2/3	28	qa82\2			2/3

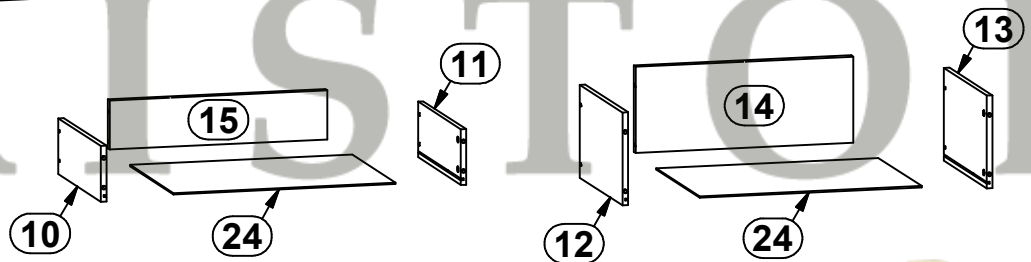
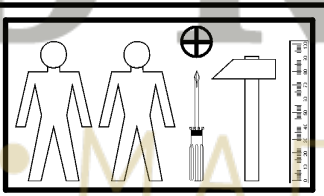
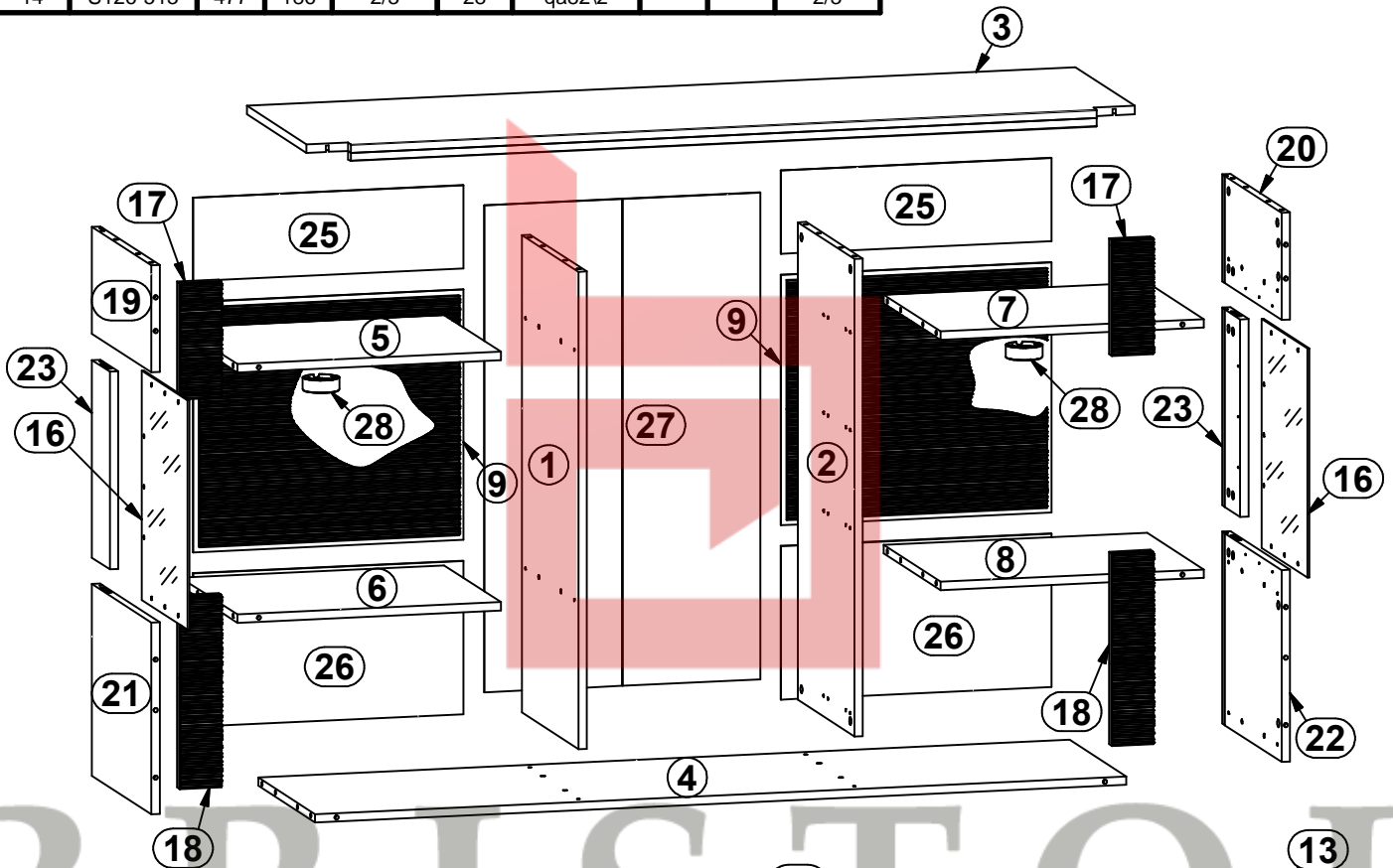
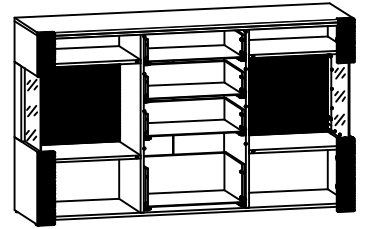

32x φ6x13 mm e3	34x φ8x30 mm f1	16x φ6.5x40 mm f25	8x φ8x50 mm f6	4x k1	1x k53	55x l1	18x l2	18x 20x13x3.5\1 mm n108
18x o1	2x o48\1	2x o48\2	1x φ4x25 mm p36	30x φ3.5x16 mm p38	4x φ3x12 mm p54	18x φ2.9x16 mm p55	62x φ1.5x12mm #16 r1	8x r10
16x φ12x10.5mm #12 r15	2x φ20x12mm #16 r36	2x 6.7\7.8 r37	62x r42	24 ø16 s2	12x φ11x5 mm s43	4x 350 mm w83\L	4x 350 mm w83\P	1x n26\1
1x φ3.5x16 mm p38								

1  

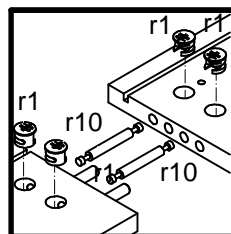
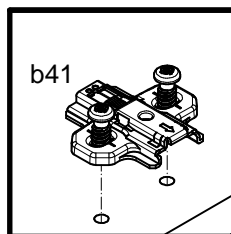
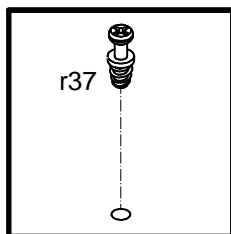
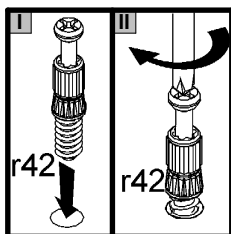
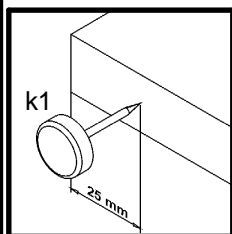
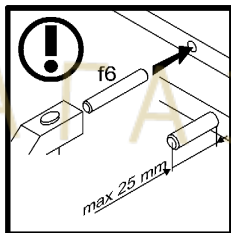
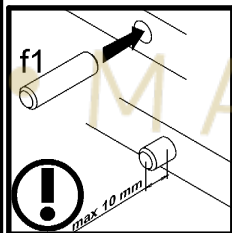
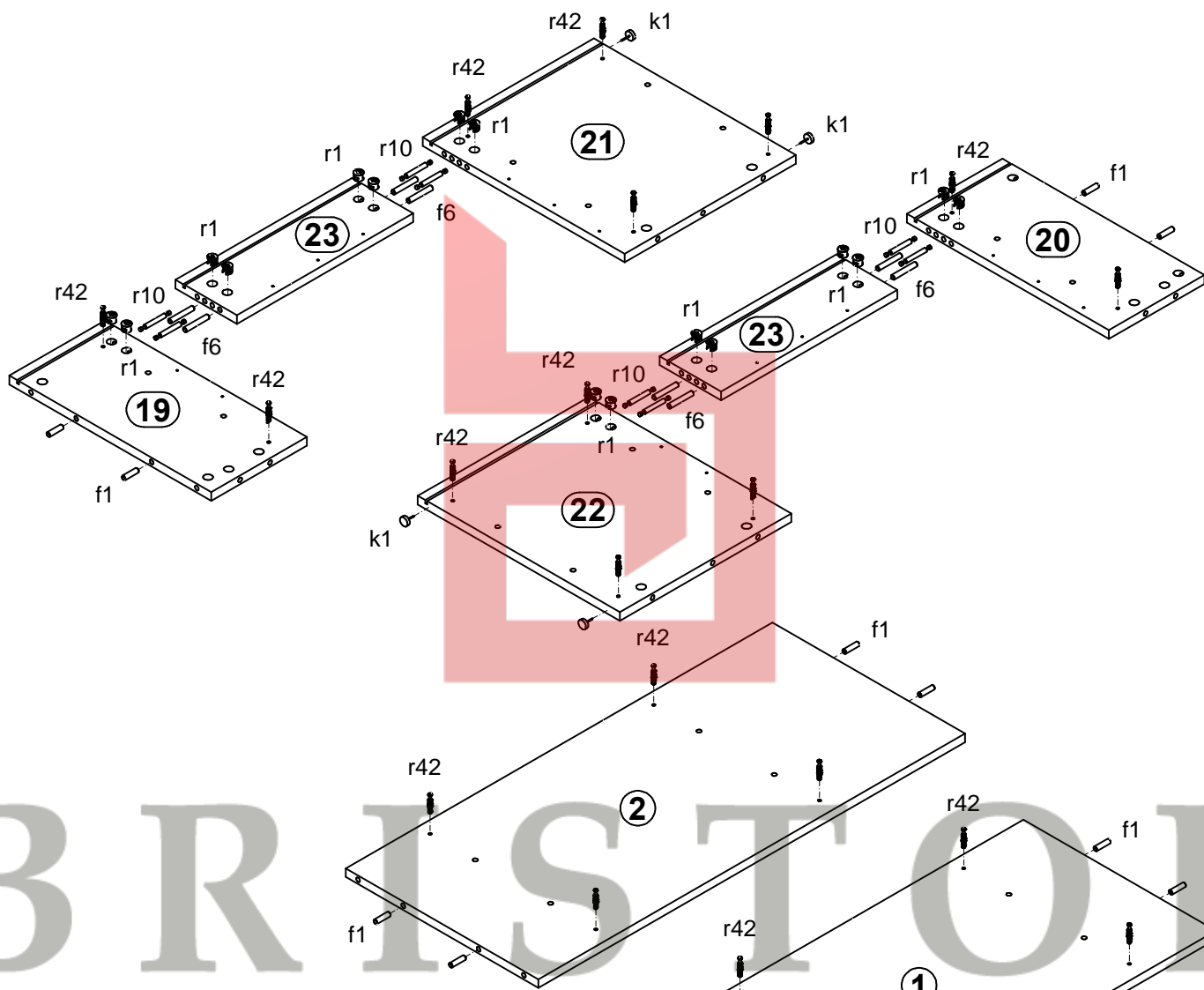
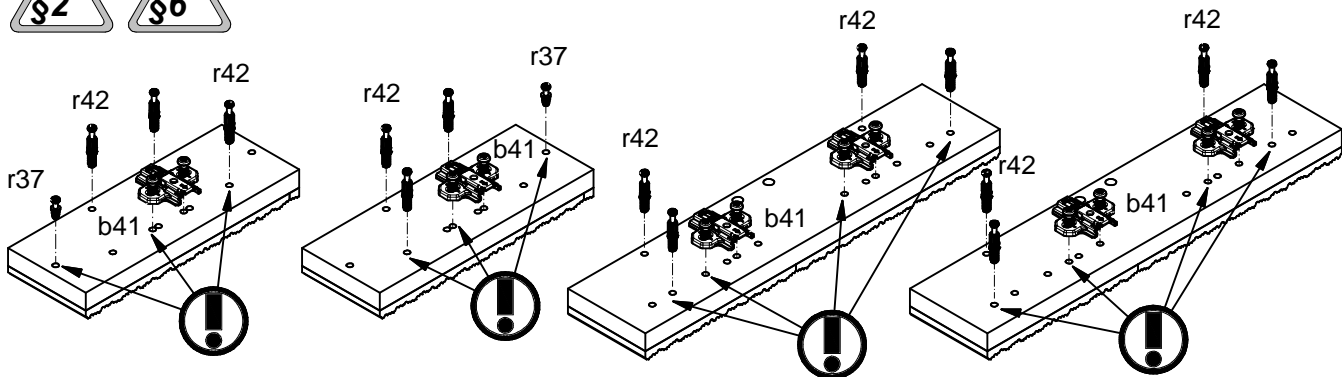

2

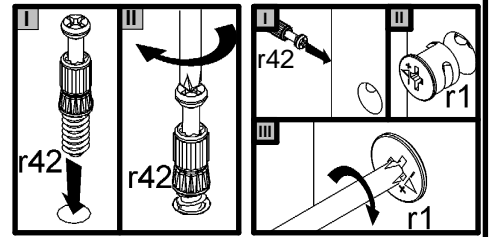
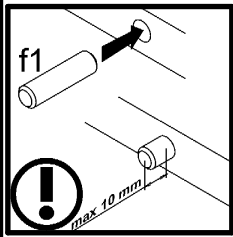
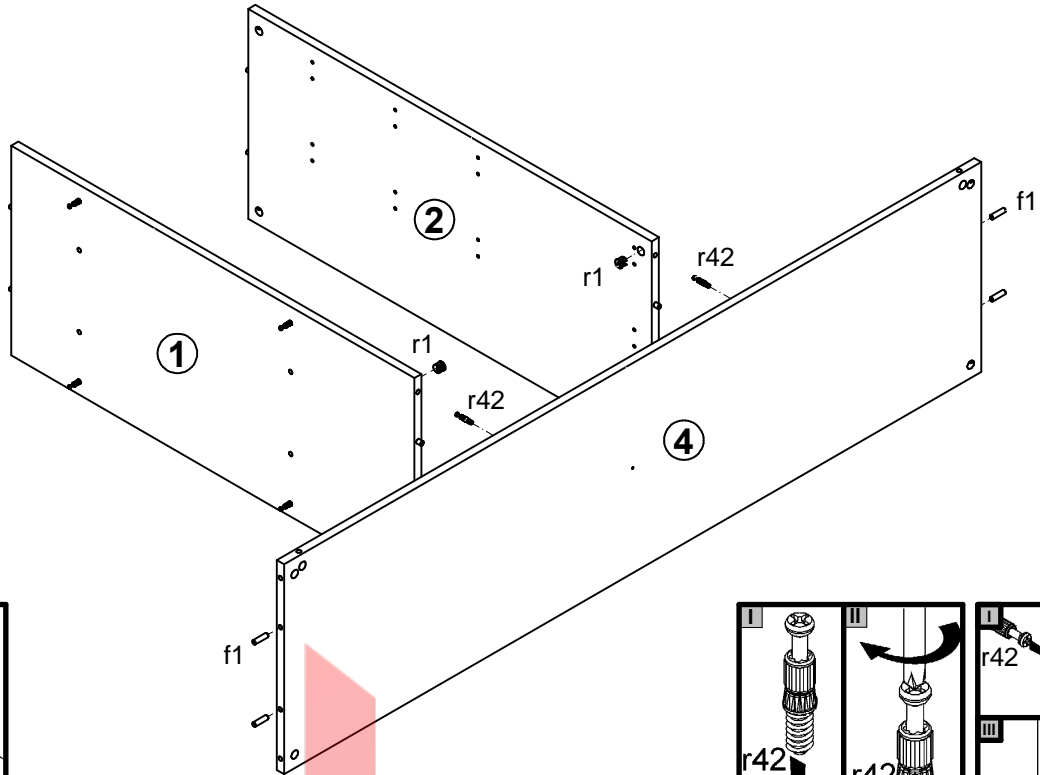

3

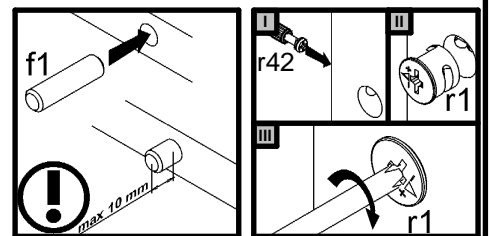
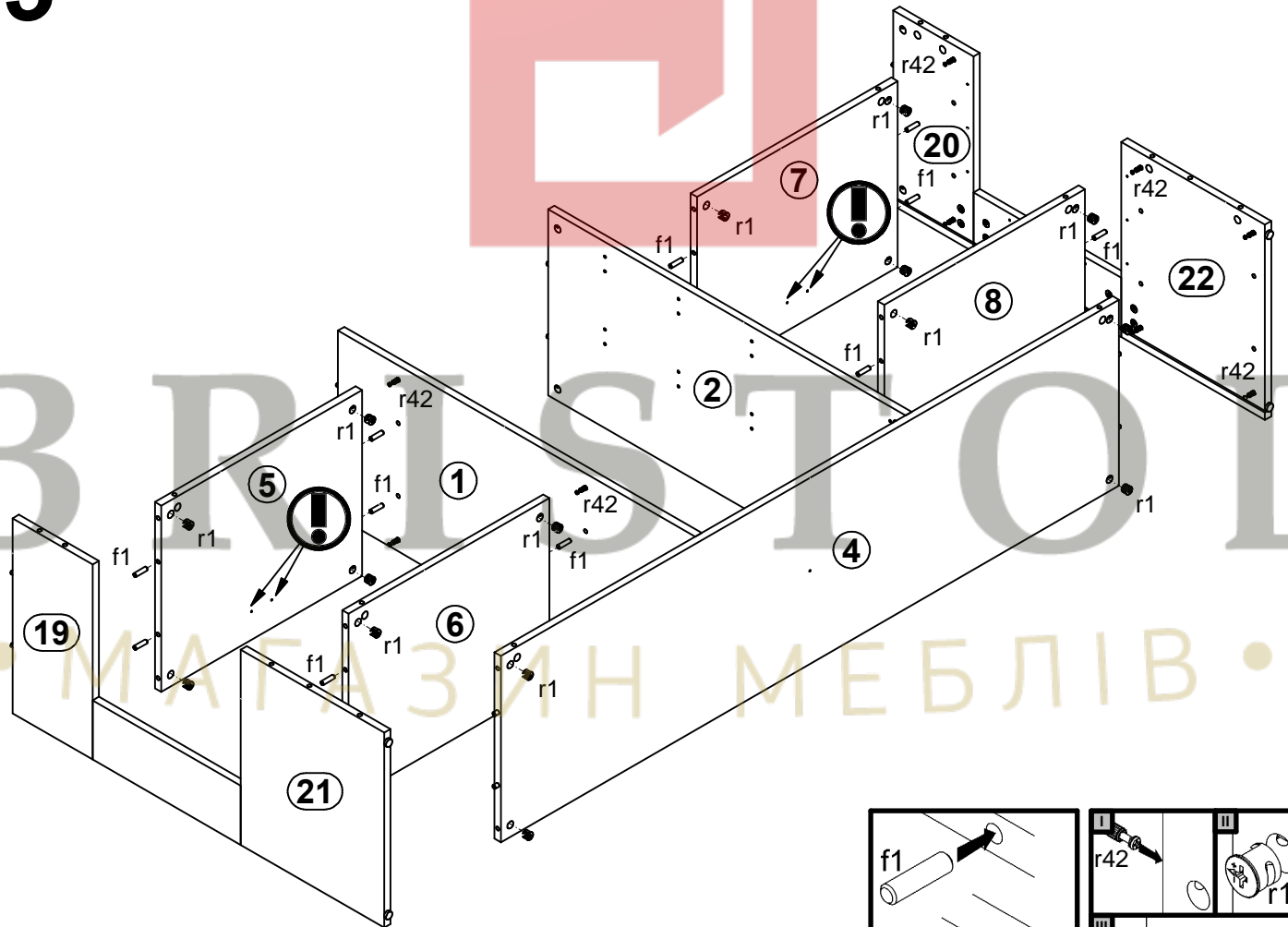

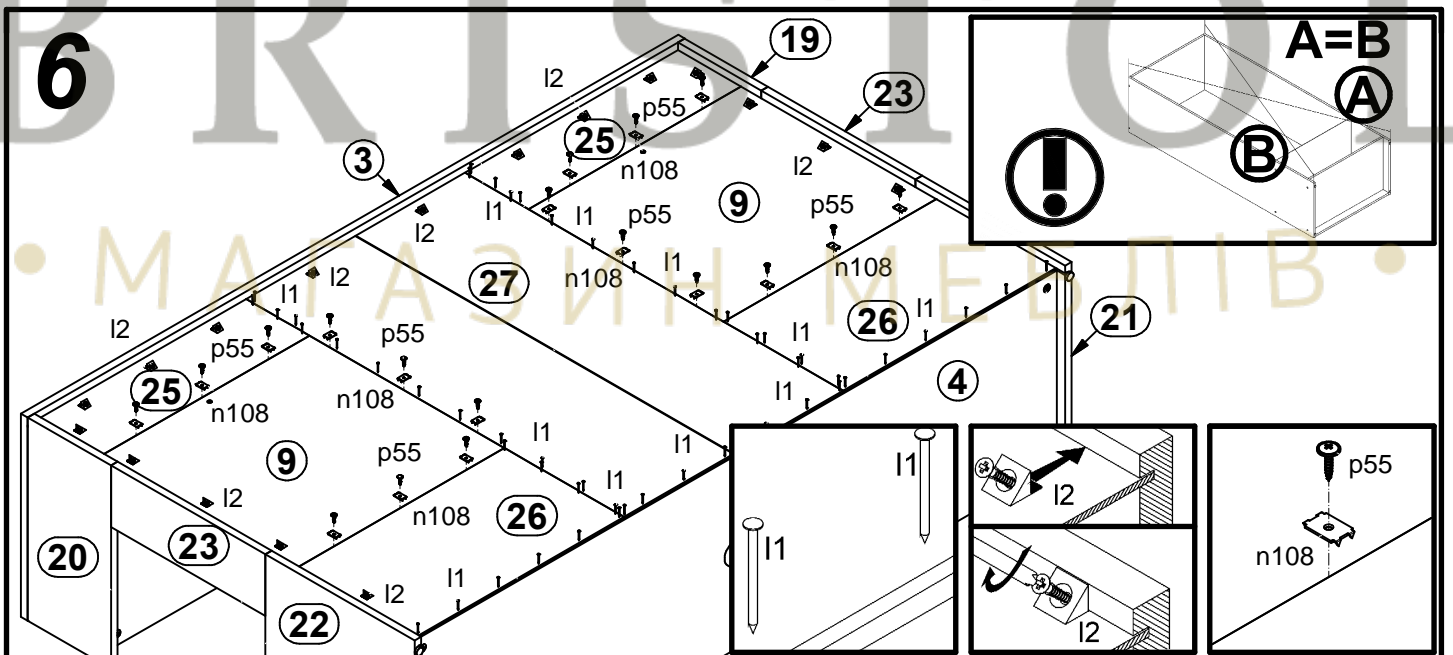
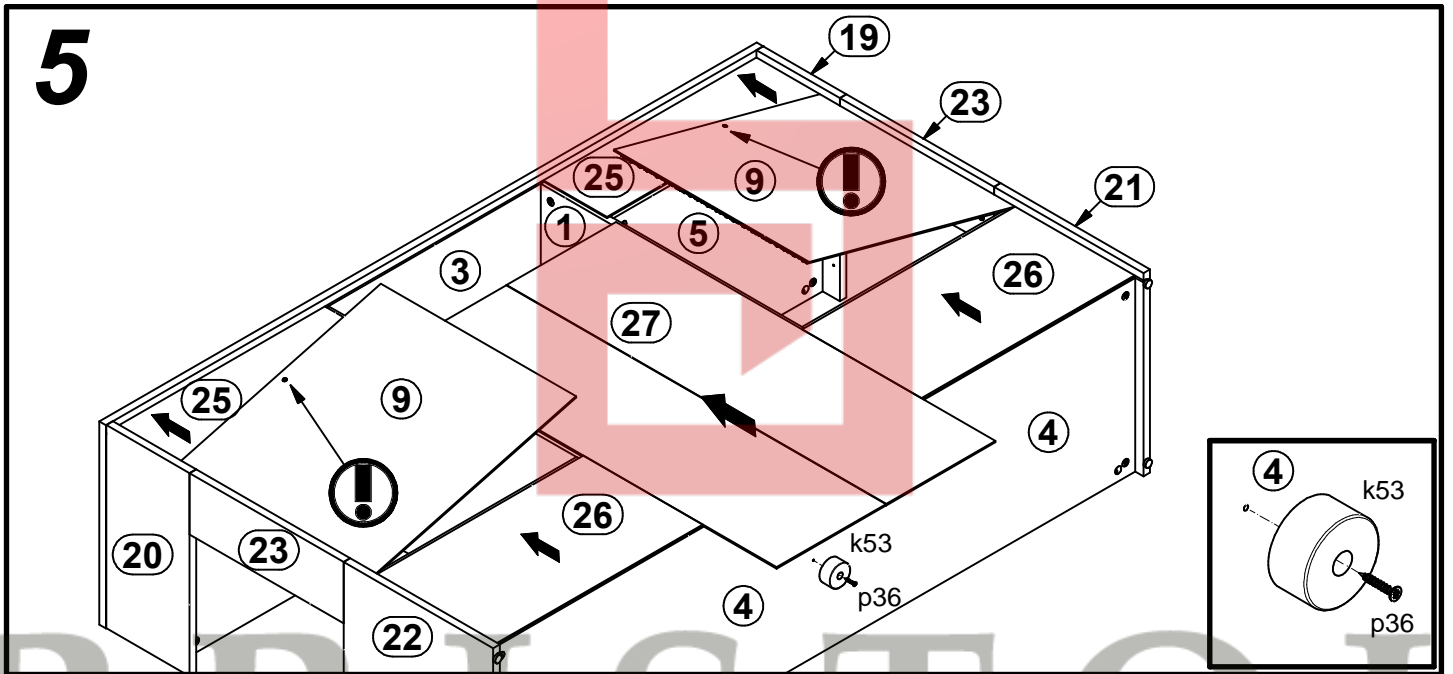
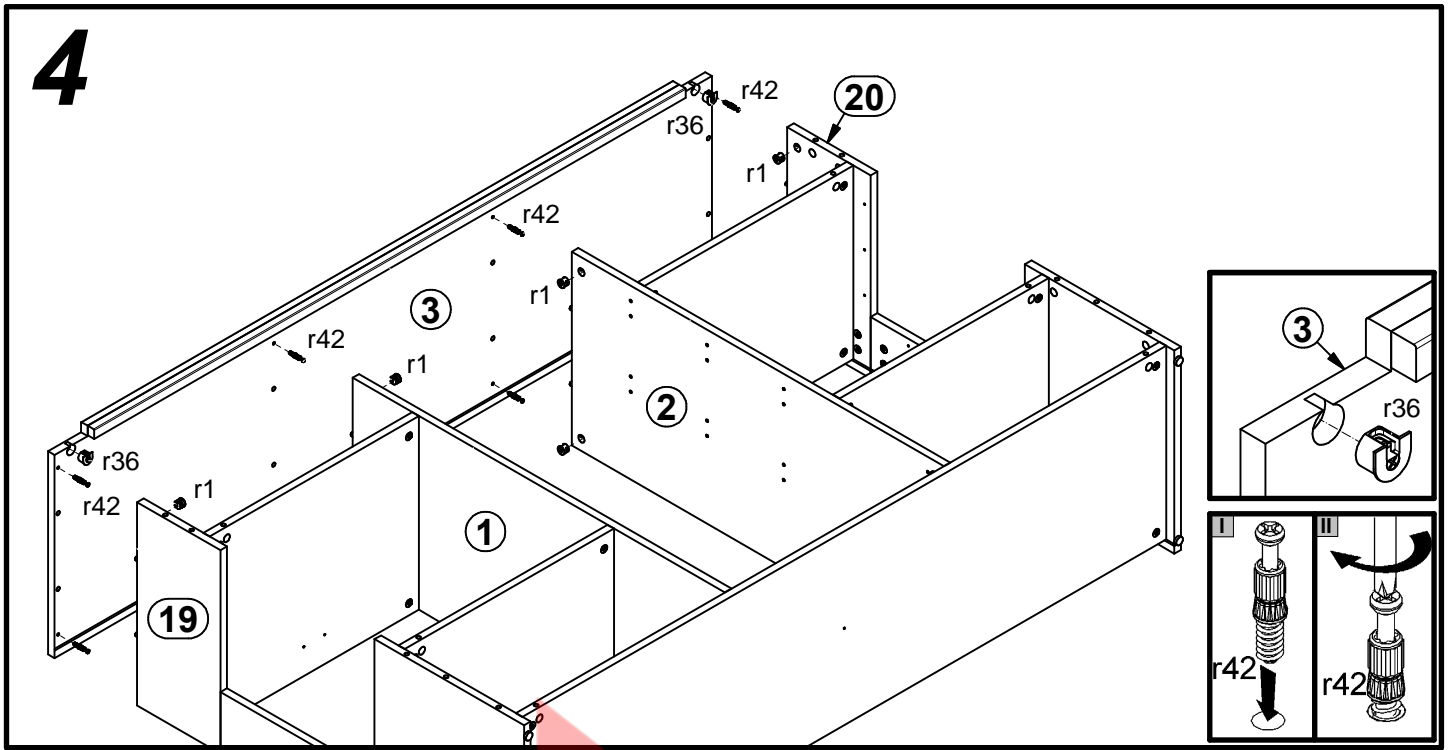

7

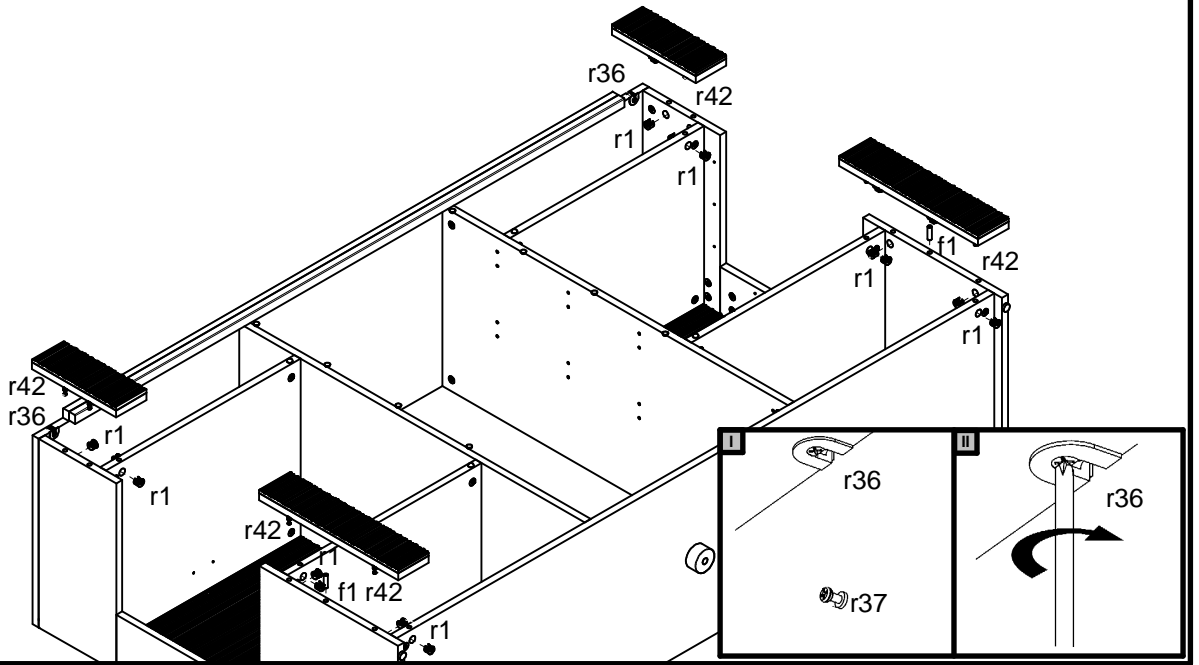
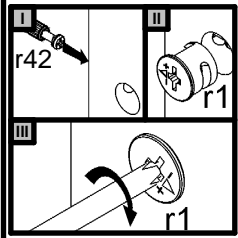
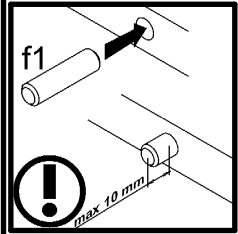

8

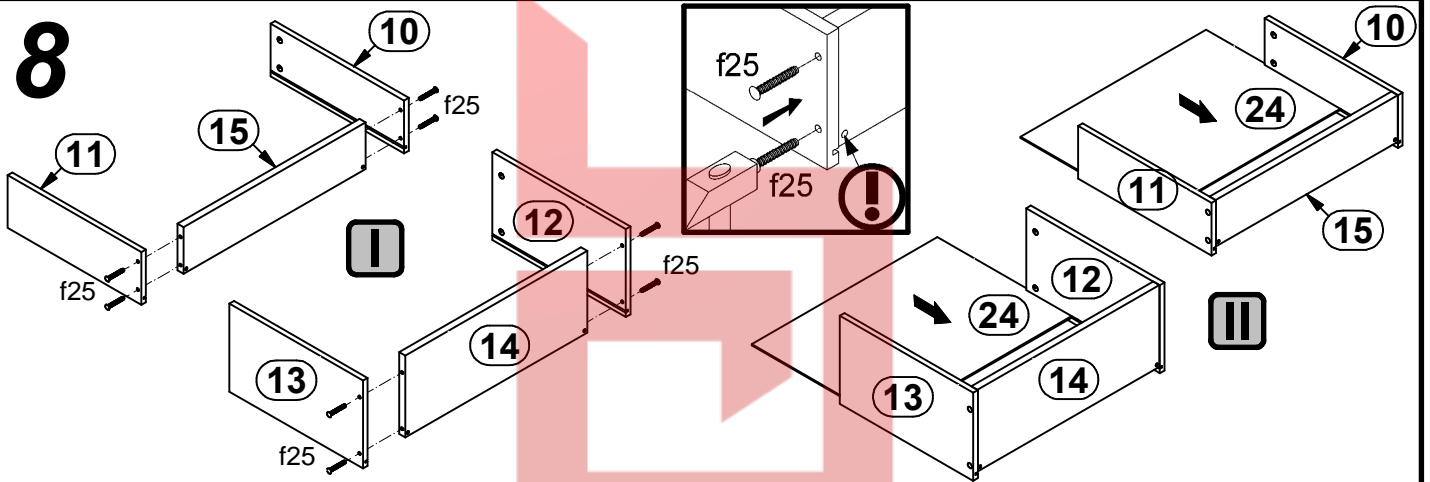

9

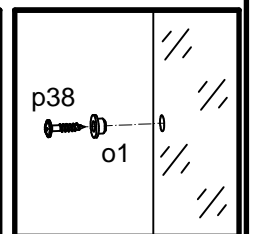
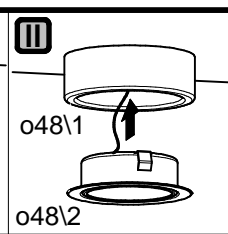
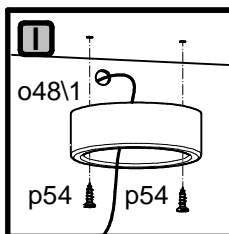
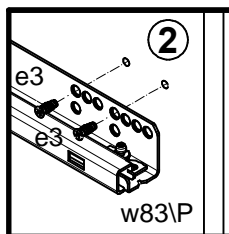
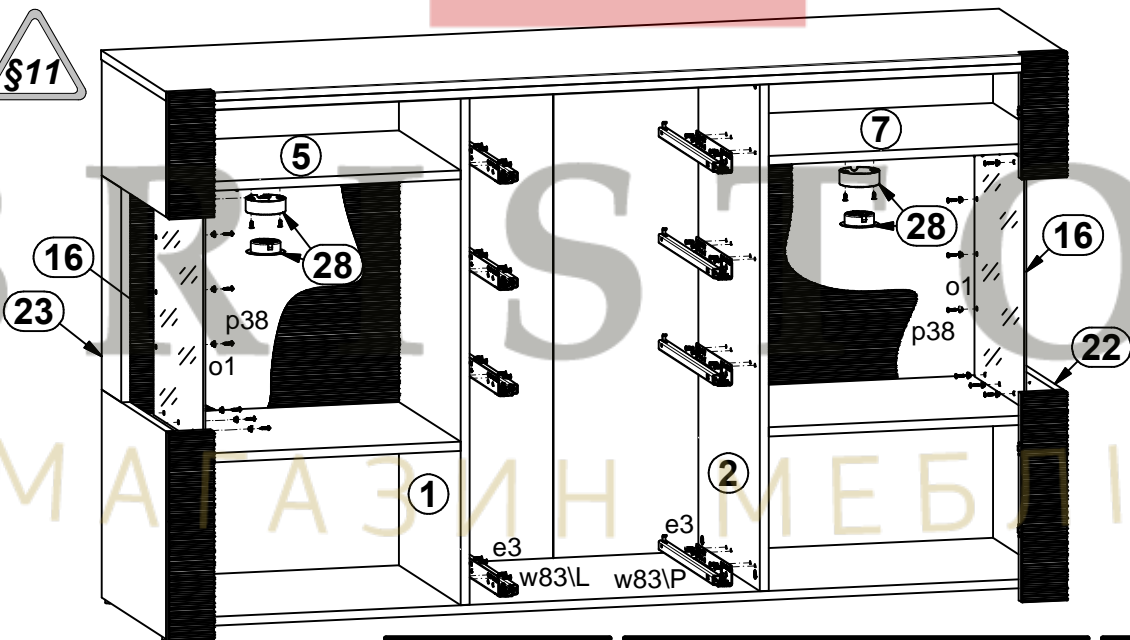

A	B	C	D
1	S126-020	530	343
2	S126-021	530	183
3	S126-556A	509	435
4	S126-705	449	343
5	S126-706	449	183
6	S126-707	449	343
7	S126-708	449	183

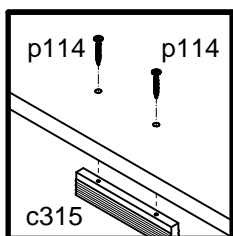
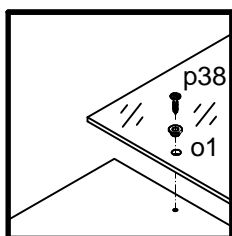
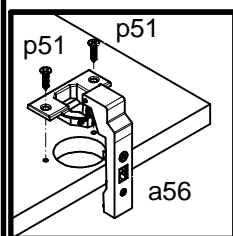
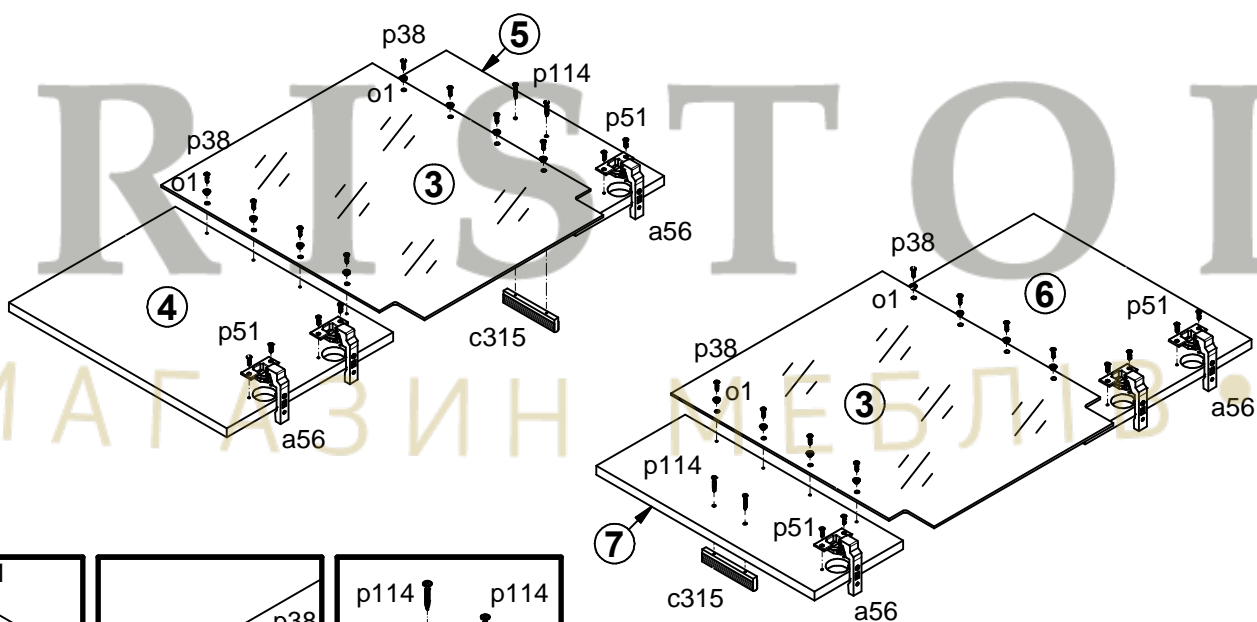
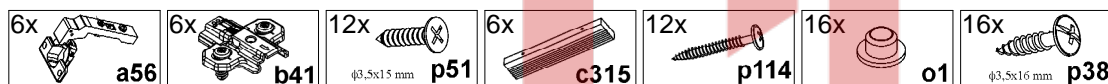
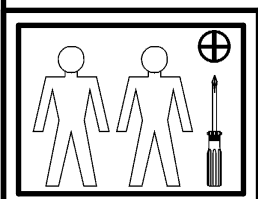
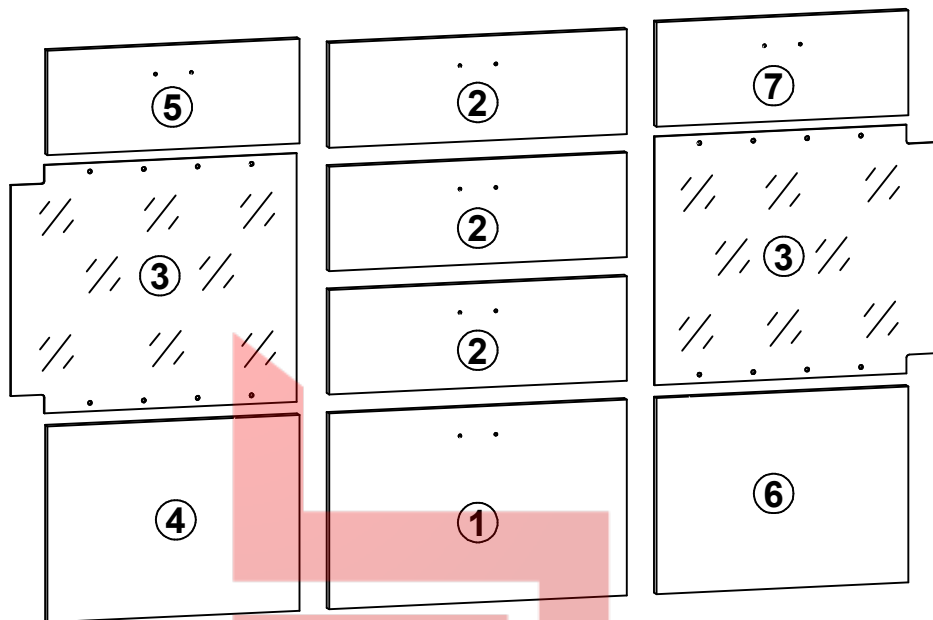
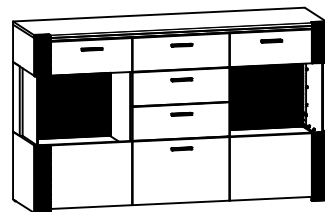

2

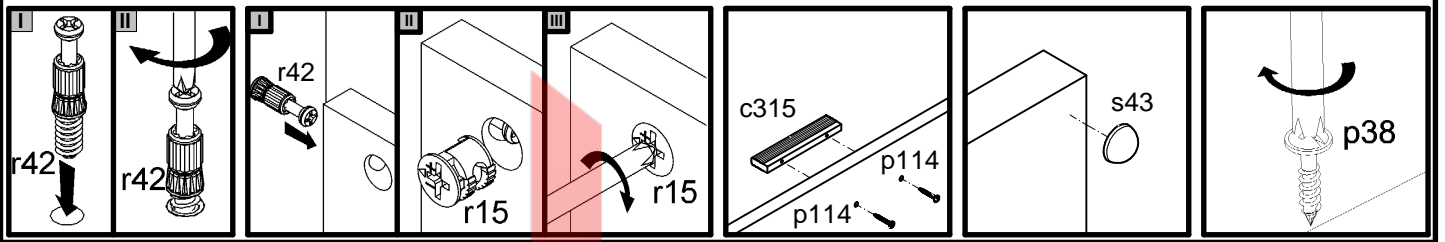
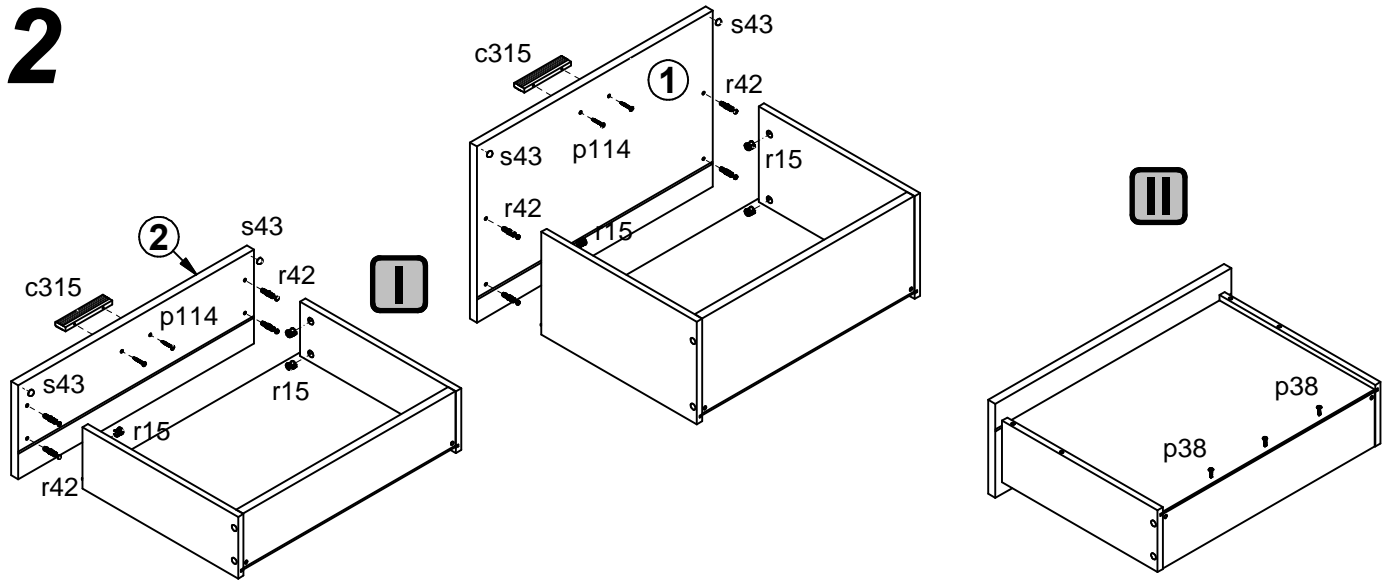

3

