

# RAFLO

S126-SZF3D/22/17

| A  | B        | C    |     | D   |
|----|----------|------|-----|-----|
| 1  | S126-170 | 2130 | 629 | 1/5 |
| 2  | S126-171 | 2130 | 629 | 1/5 |
| 3  | S126-172 | 2094 | 609 | 2/5 |
| 4  | S126-209 | 1660 | 651 | 2/5 |
| 5  | S126-313 | 1627 | 609 | 2/5 |
| 6  | S126-316 | 1052 | 609 | 3/5 |
| 7  | S126-317 | 559  | 609 | 3/5 |
| 8  | S126-318 | 559  | 609 | 3/5 |
| 9  | S126-590 | 1074 | 80  | 3/5 |
| 10 | S126-971 | 2112 | 572 | 1/5 |
| 11 | S126-972 | 2112 | 532 | 1/5 |
| 12 | dr-1046  | 1046 | 30  | 3/5 |
| 13 | S126-592 | 1074 | 80  | 3/5 |
| 14 | LH-2082  | 2082 | 14  | 1/5 |

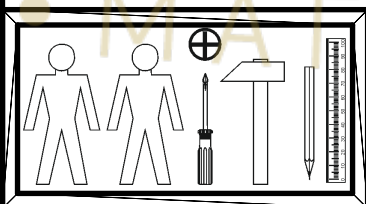
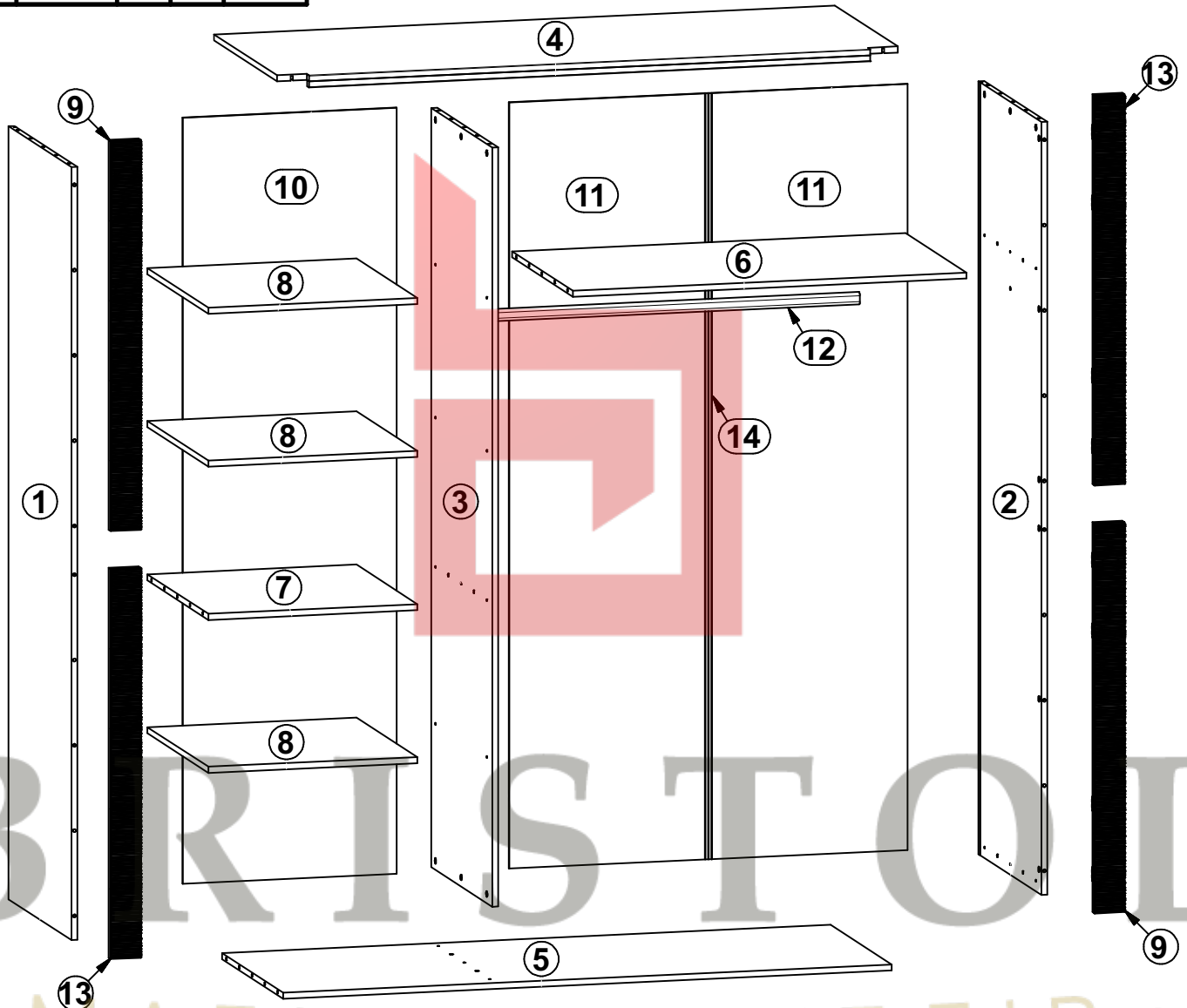
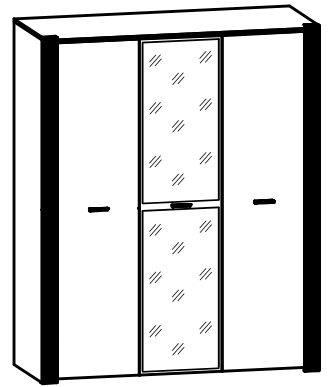

|                            |                       |                           |                      |                  |                       |             |                         |                       |
|----------------------------|-----------------------|---------------------------|----------------------|------------------|-----------------------|-------------|-------------------------|-----------------------|
| 12x<br>φ5x17 mm<br>d1      | 28x<br>φ8x30 mm<br>f1 | 4x<br>k1                  | 1x<br>k53            | 70x<br>l1        | 24x<br>l2             | 2x<br>n1    | 2x<br>φ3,5x13 mm<br>p1  | 1x<br>φ4x25 mm<br>p36 |
| 42x<br>φ1,5x12mm #16<br>r1 | 42x<br>r16            | 2x<br>φ20x12mm #16<br>r36 | 2x<br>6,7/7,8<br>r37 | 30x<br>ø16<br>s2 | 6x<br>φ11x5 mm<br>s43 | 1x<br>n2611 | 1x<br>φ3,5x16 mm<br>p38 |                       |

1 

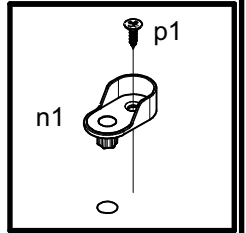
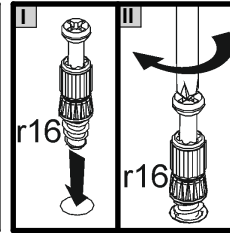
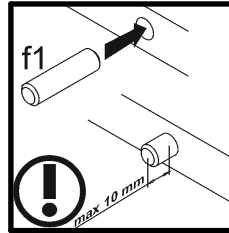
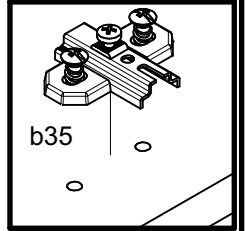
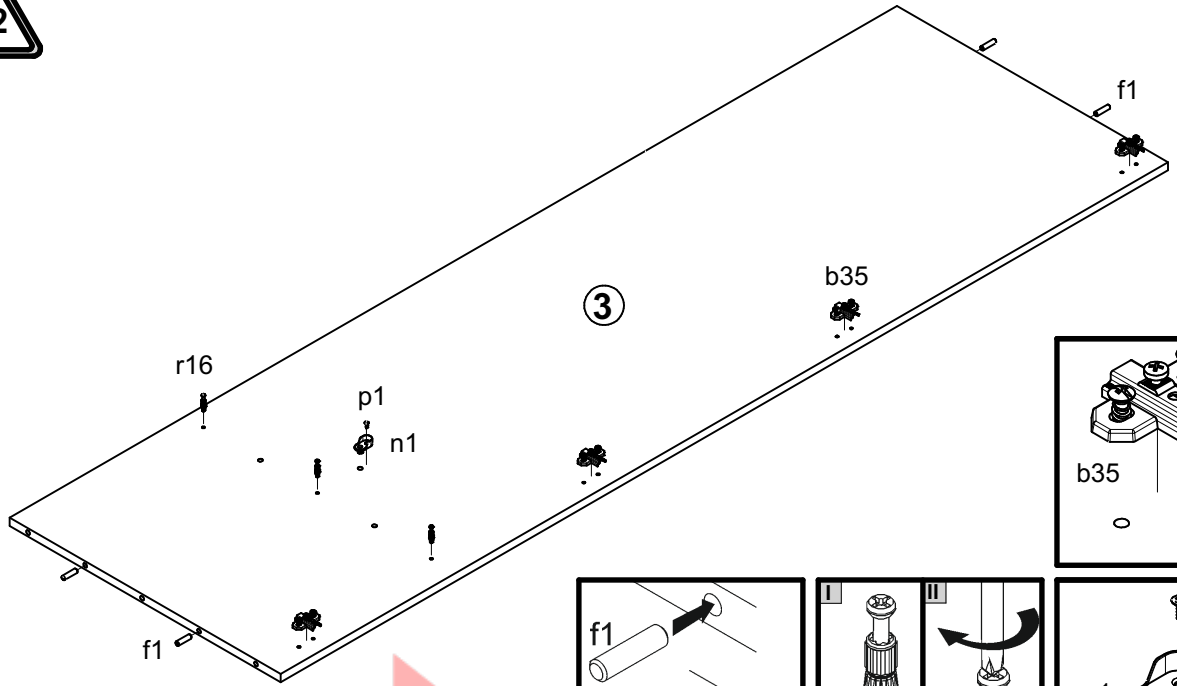

2 

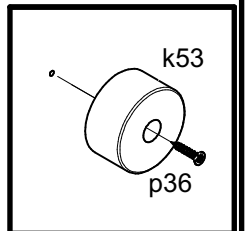
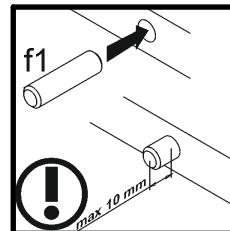
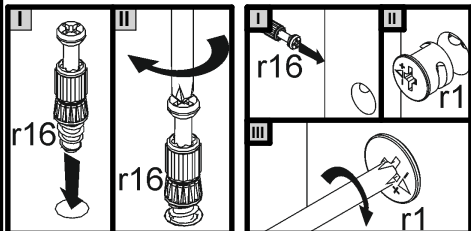
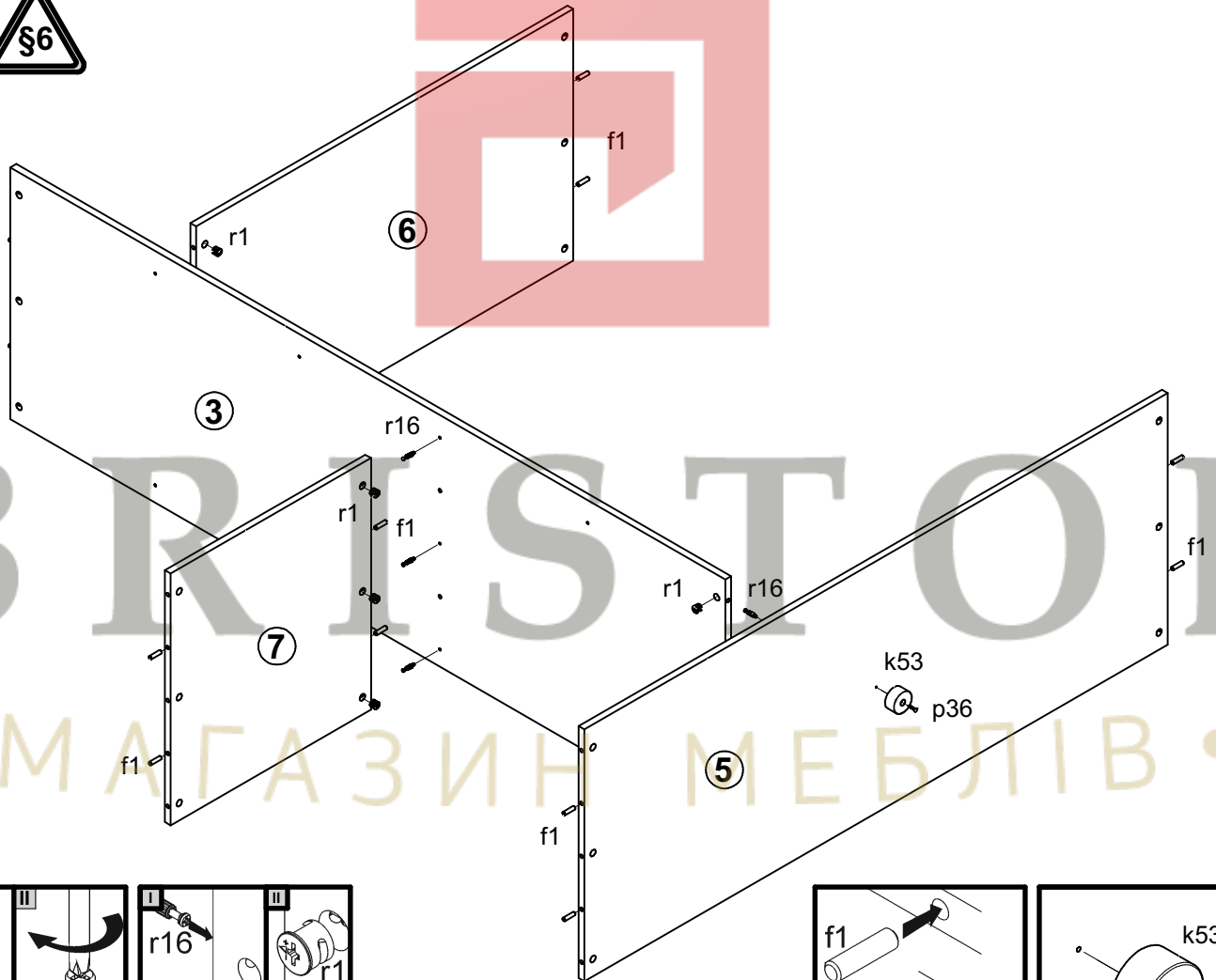

# 3

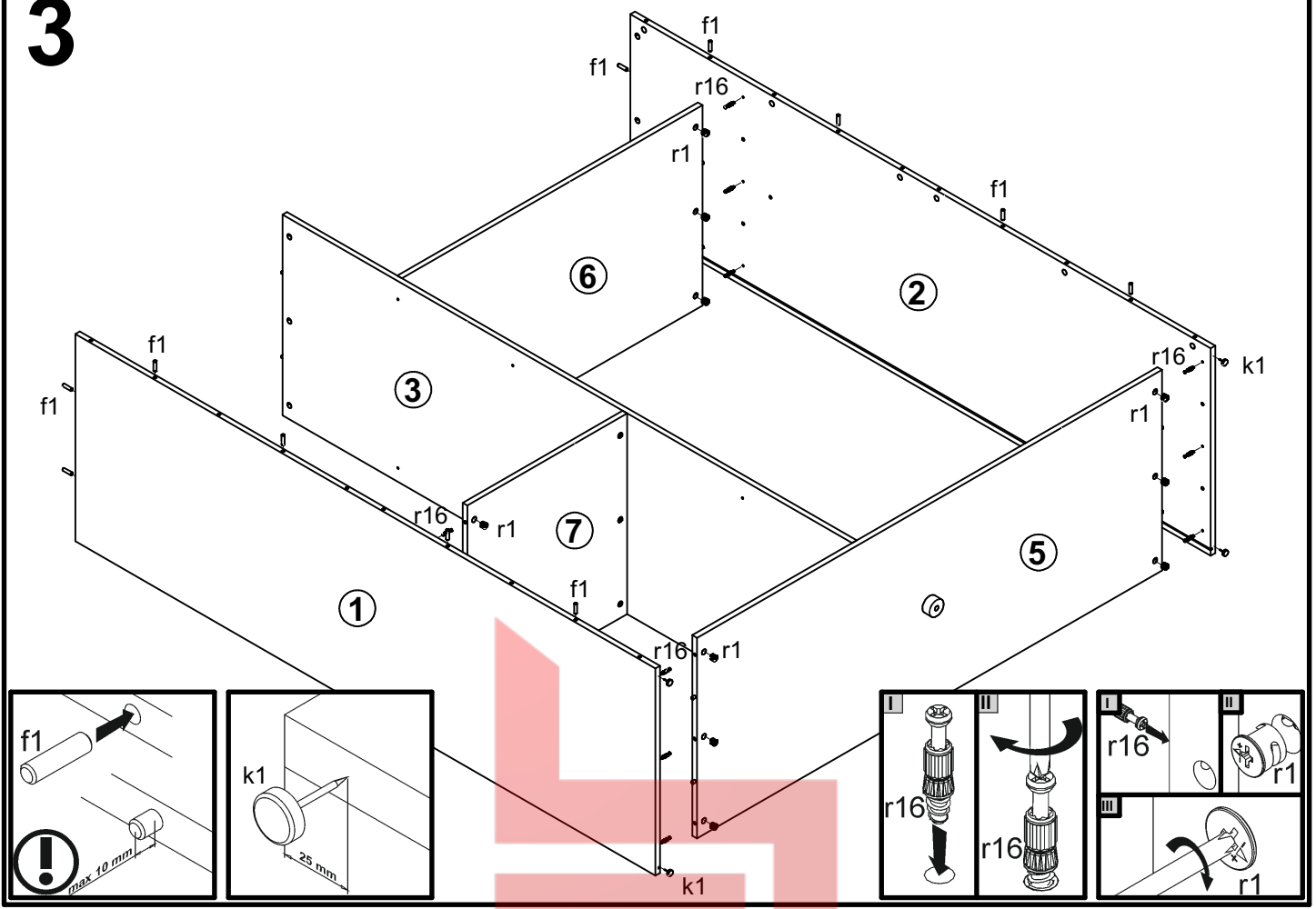

# 4

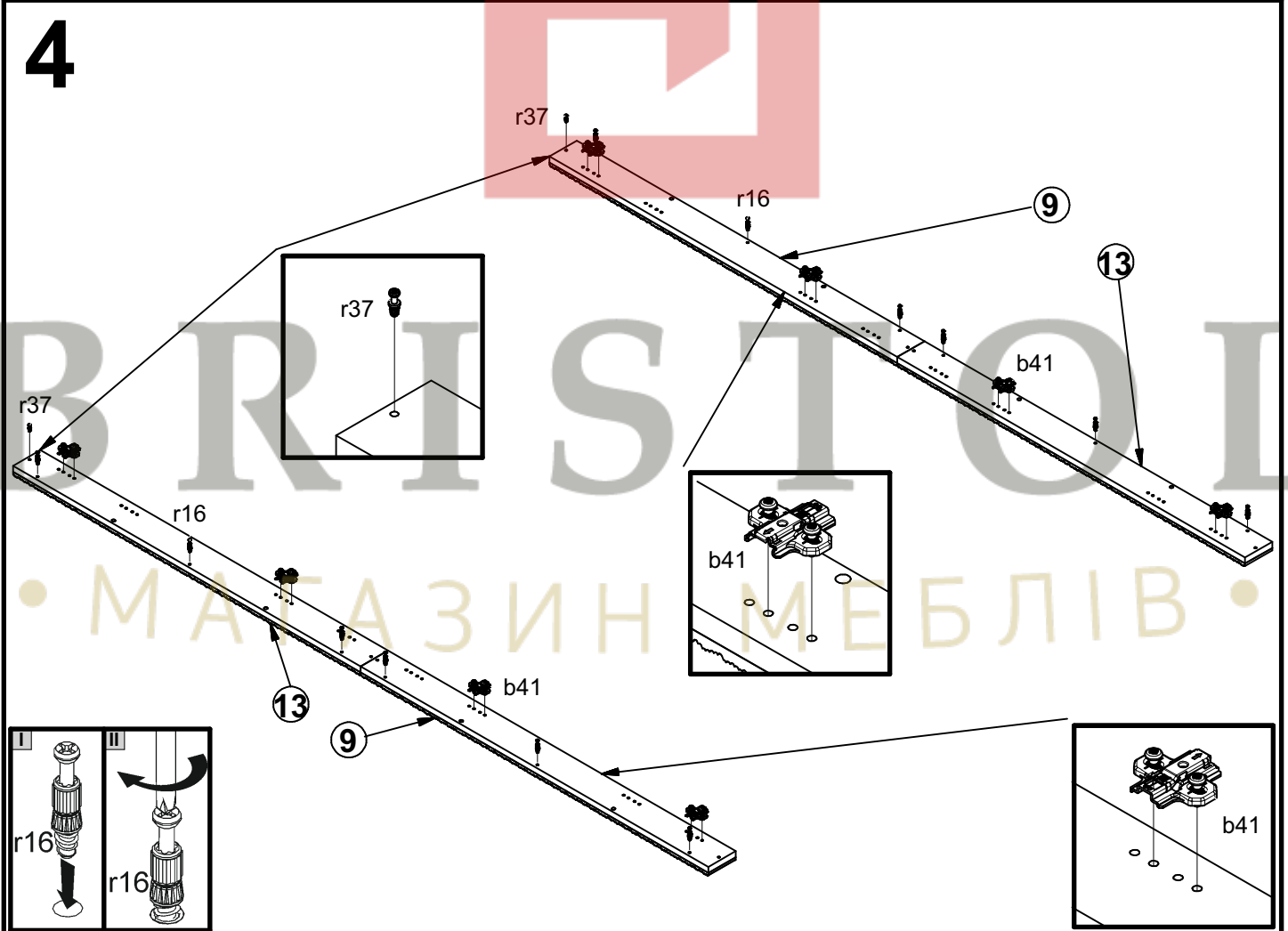

# 5

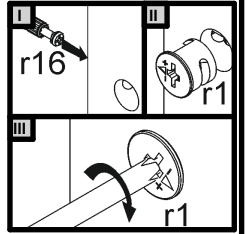
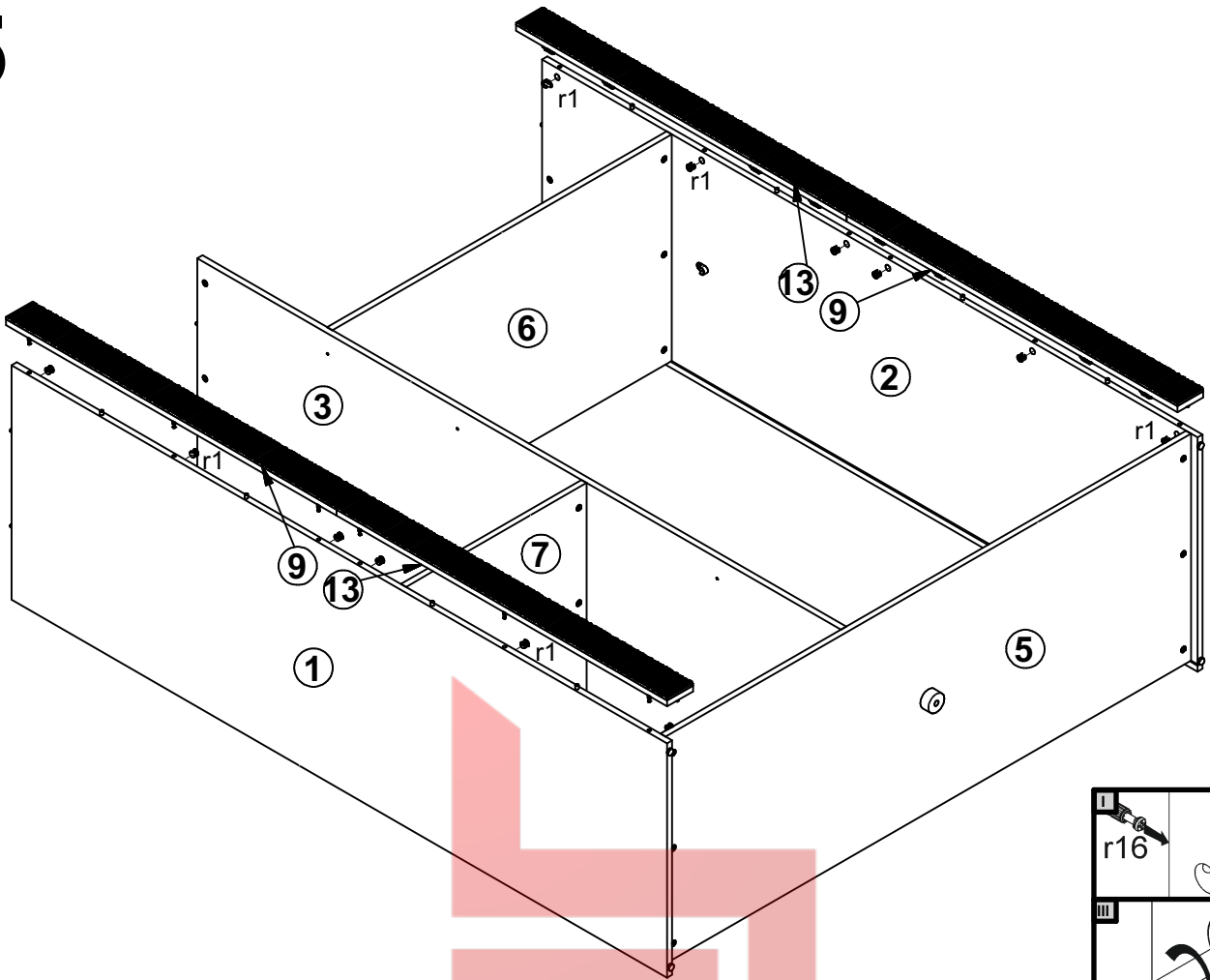

# 6

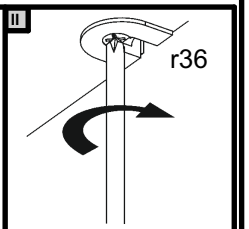
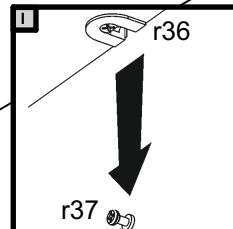
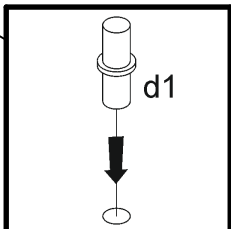
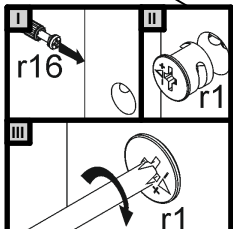
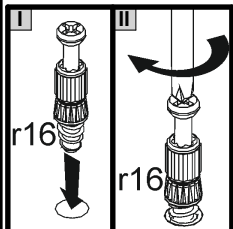
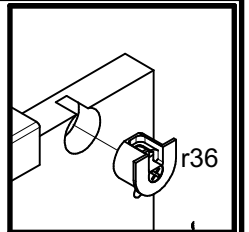
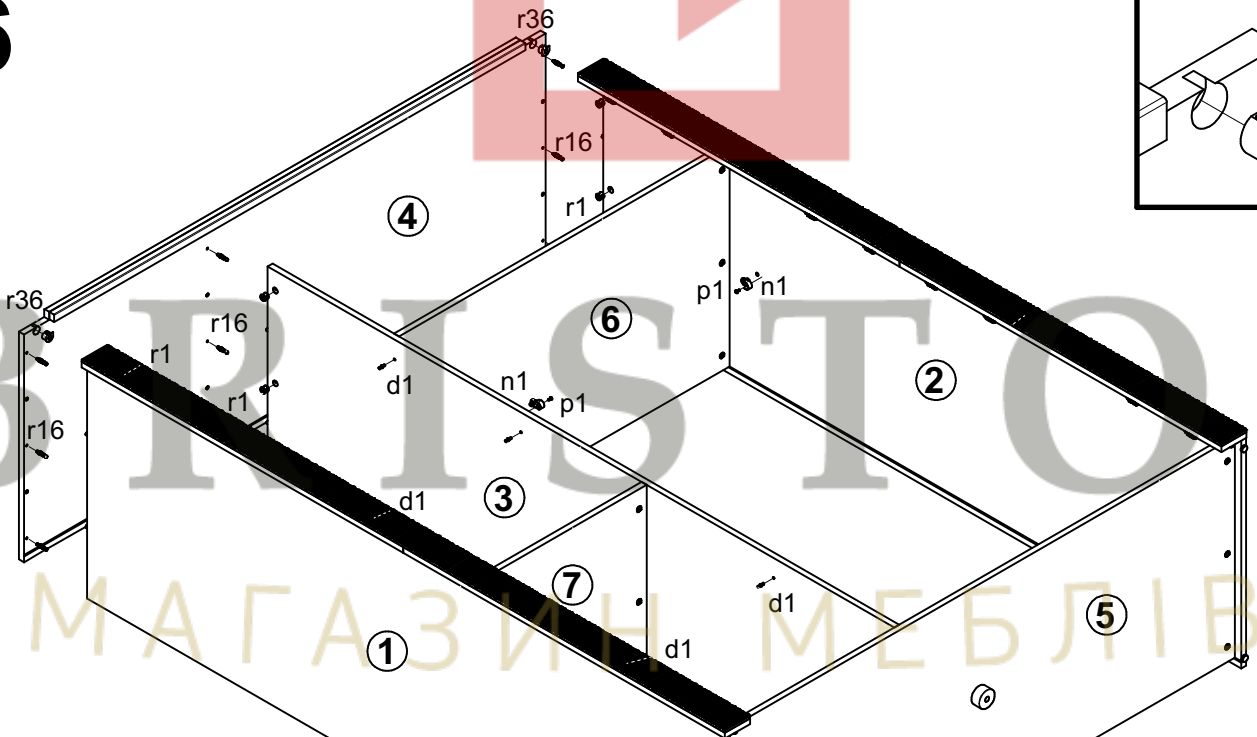



7

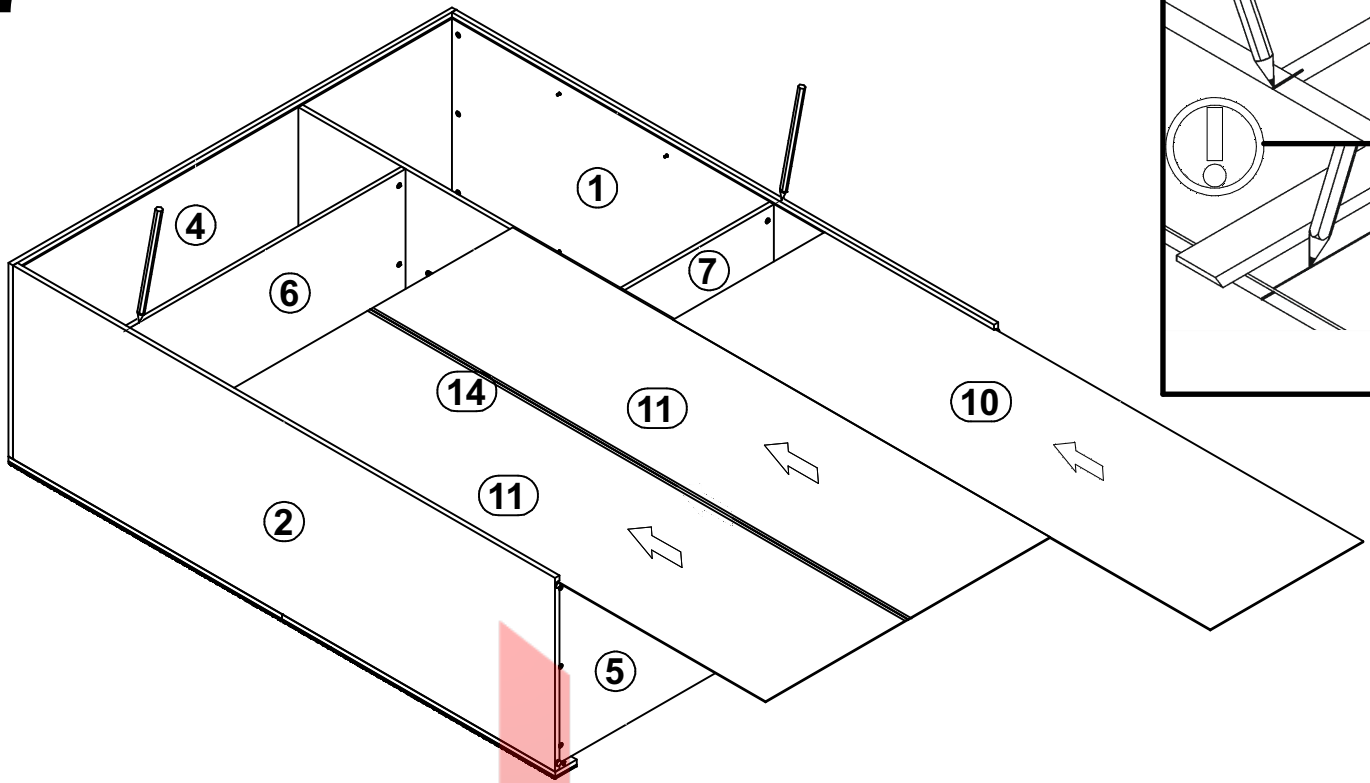

8

§18

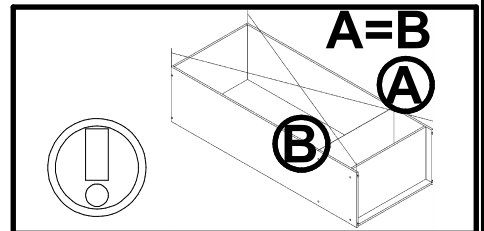
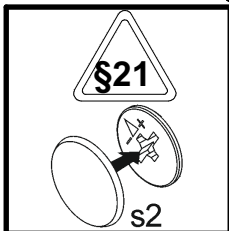
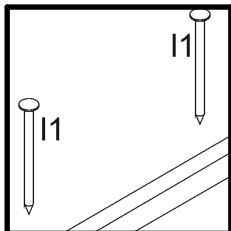
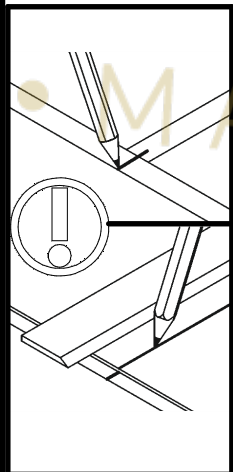
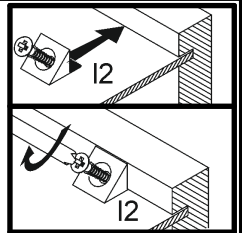
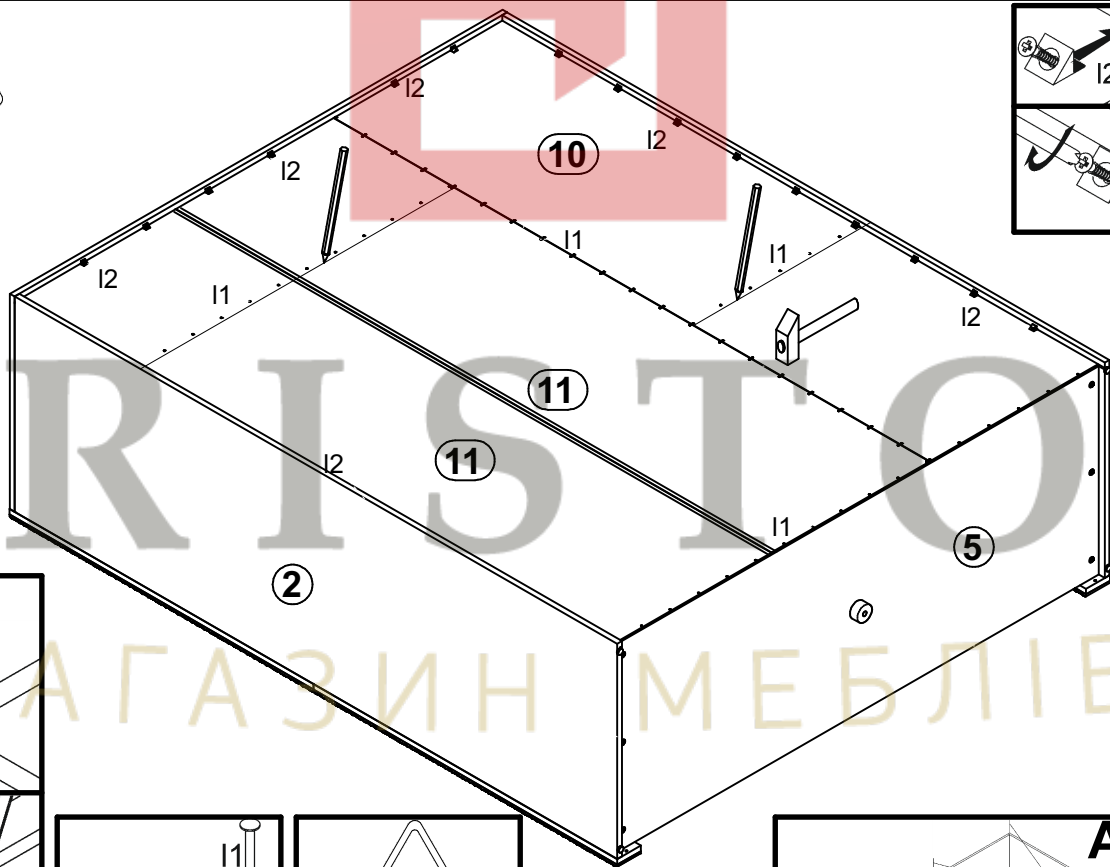

# RAFLO

S126-SZF3D/22/17

| A | B        | C    | D   |
|---|----------|------|-----|
| 1 | S126-040 | 2089 | 496 |
| 2 | S126-041 | 2089 | 496 |

