

RAFLO

S126-SZF3D/22/17

A	B	C		D
1	S126-170	2130	629	1/5
2	S126-171	2130	629	1/5
3	S126-172	2094	609	2/5
4	S126-209	1660	651	2/5
5	S126-313	1627	609	2/5
6	S126-316	1052	609	3/5
7	S126-317	559	609	3/5
8	S126-318	559	609	3/5
9	S126-590	1074	80	3/5
10	S126-971	2112	572	1/5
11	S126-972	2112	532	1/5
12	dr-1046	1046	30	3/5
13	S126-592	1074	80	3/5
14	LH-2082	2082	14	1/5

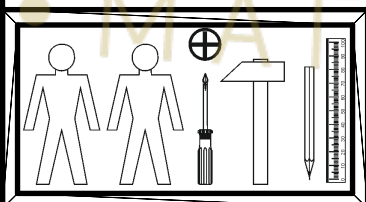
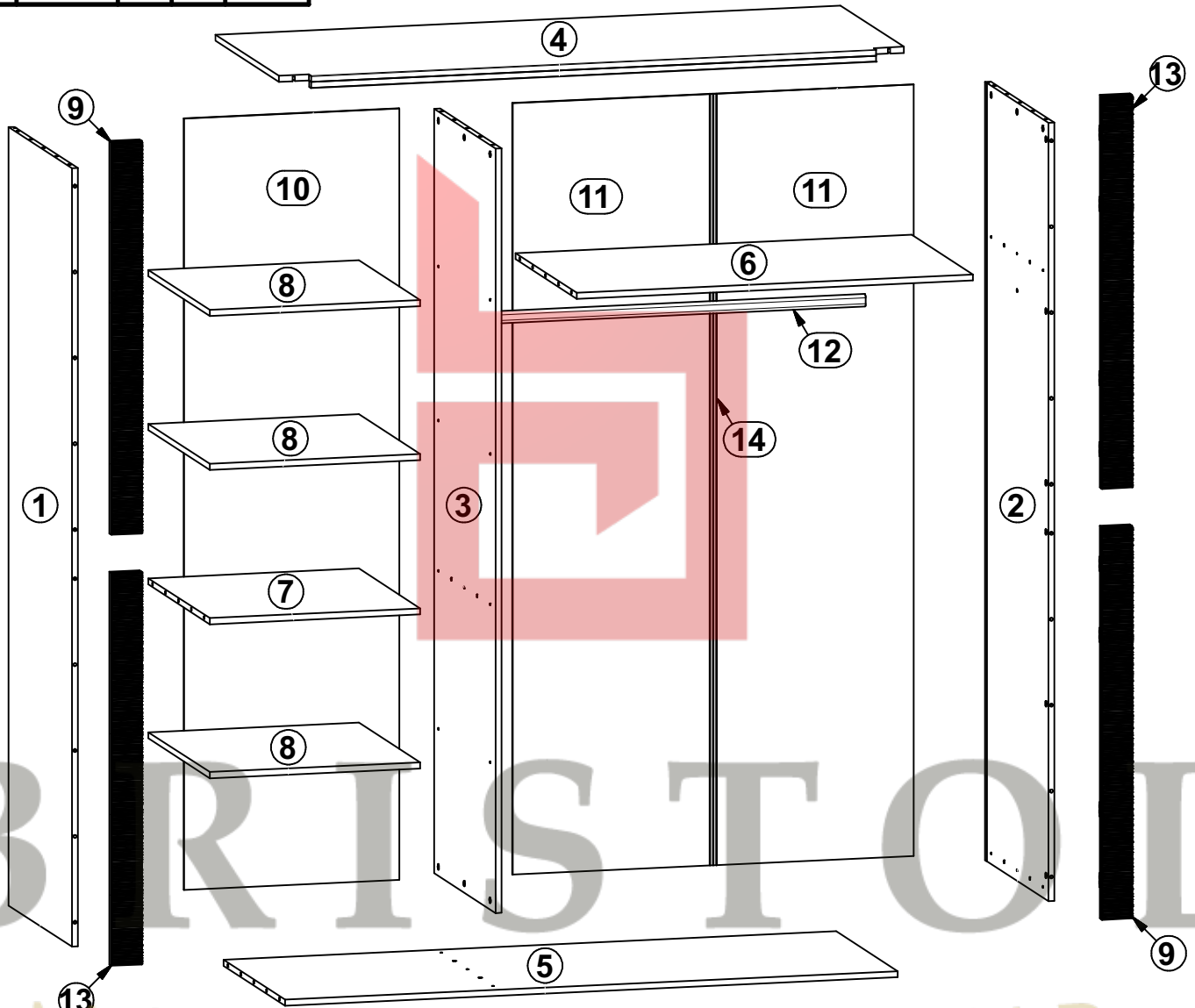
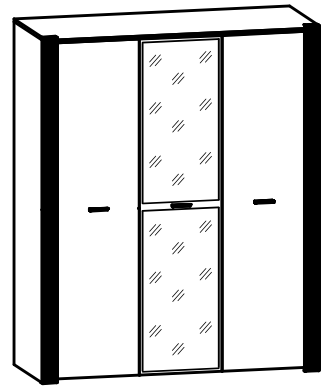

12x φ5x17 mm d1	28x φ8x30 mm f1	4x k1	1x k53	70x l1	24x l2	2x n1	2x φ3,5x13 mm p1	1x φ4x25 mm p36
42x φ1,5x12mm #16 r1	42x r16	2x φ20x12mm #16 r36	2x 6,7/7,8 r37	30x ø16 s2	6x φ11x5 mm s43	1x n2611	1x φ3,5x16 mm p38	

1 

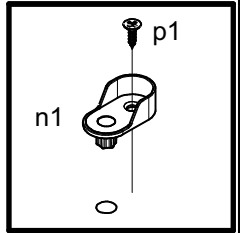
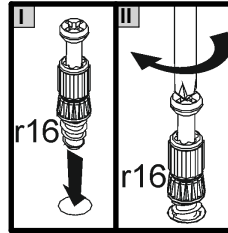
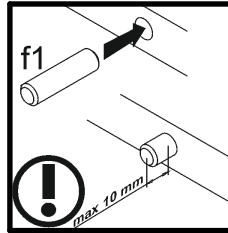
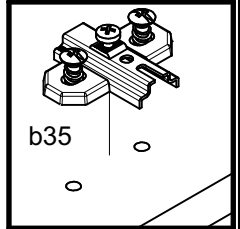
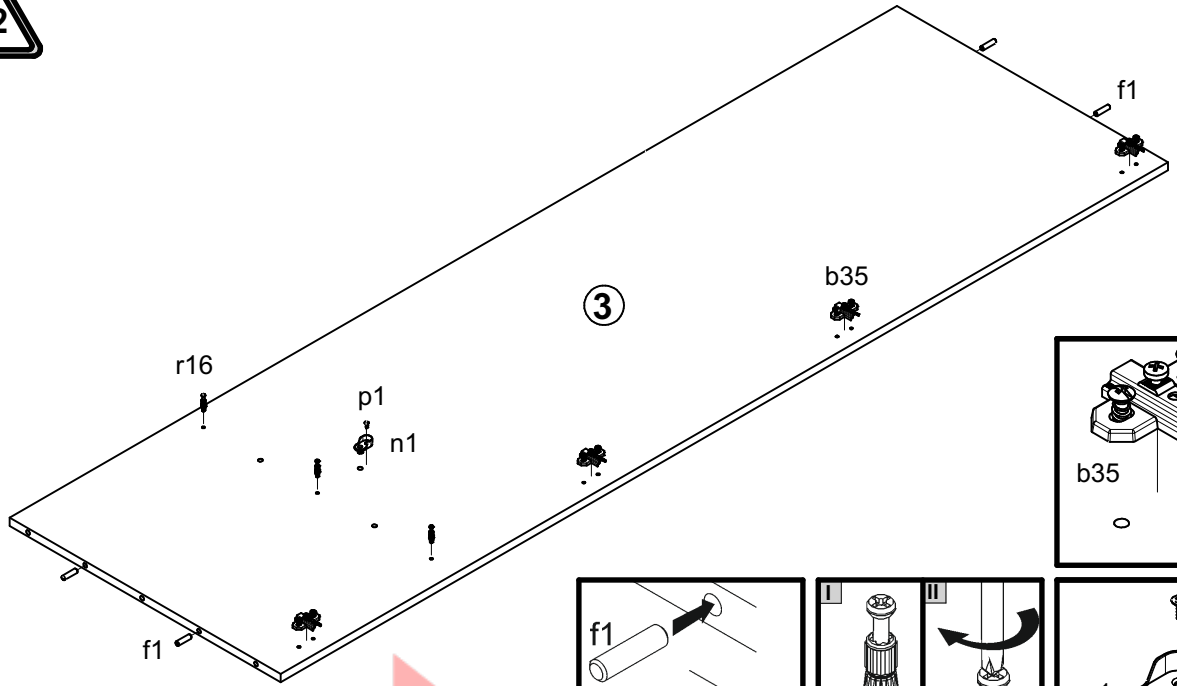

2 

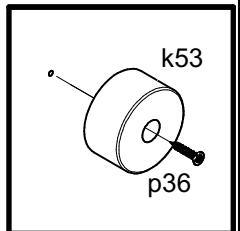
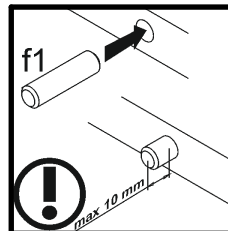
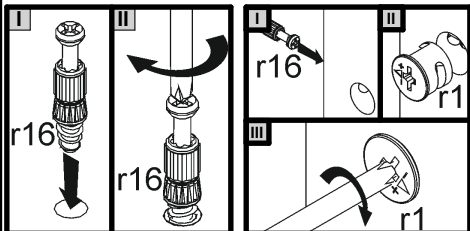
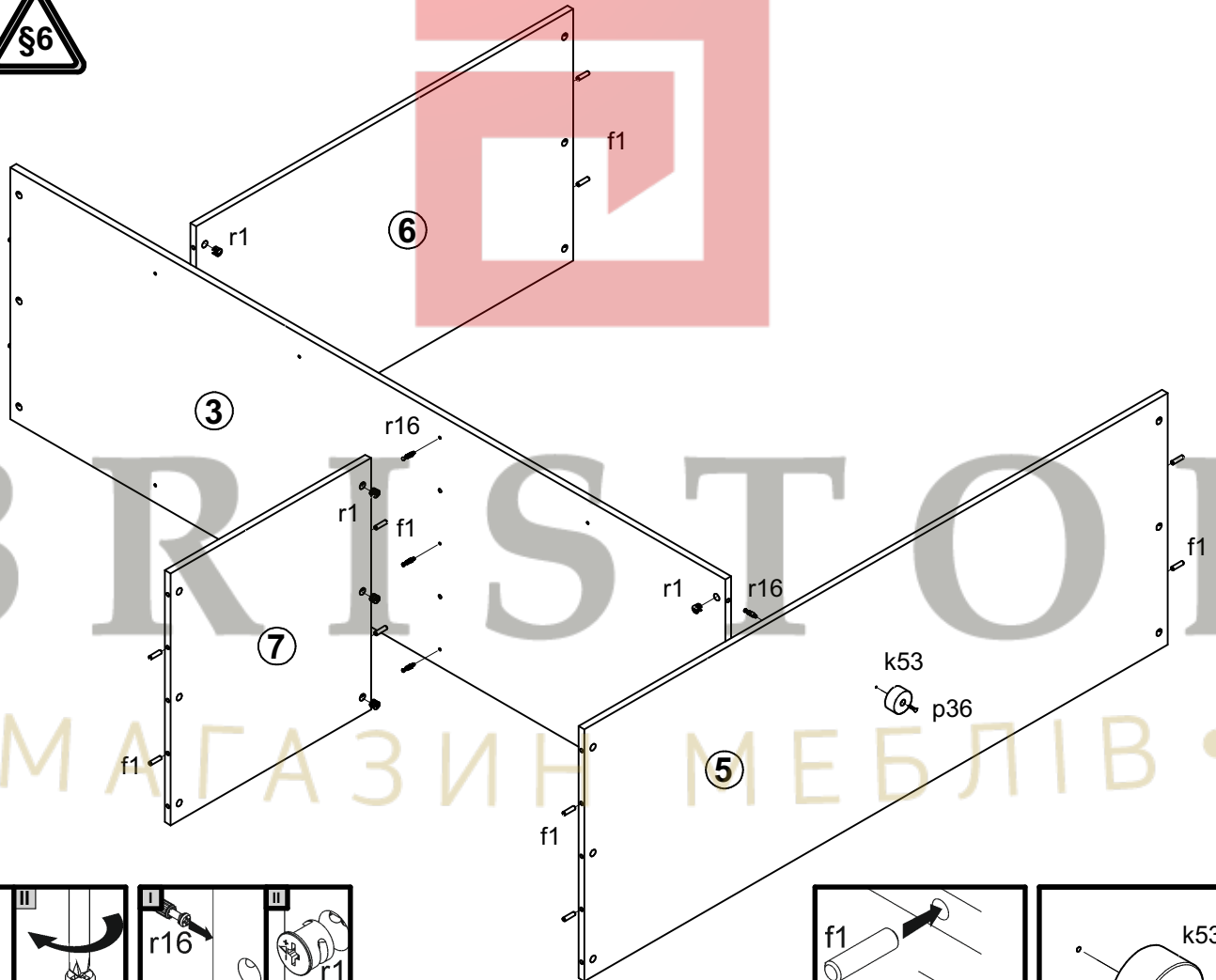

3

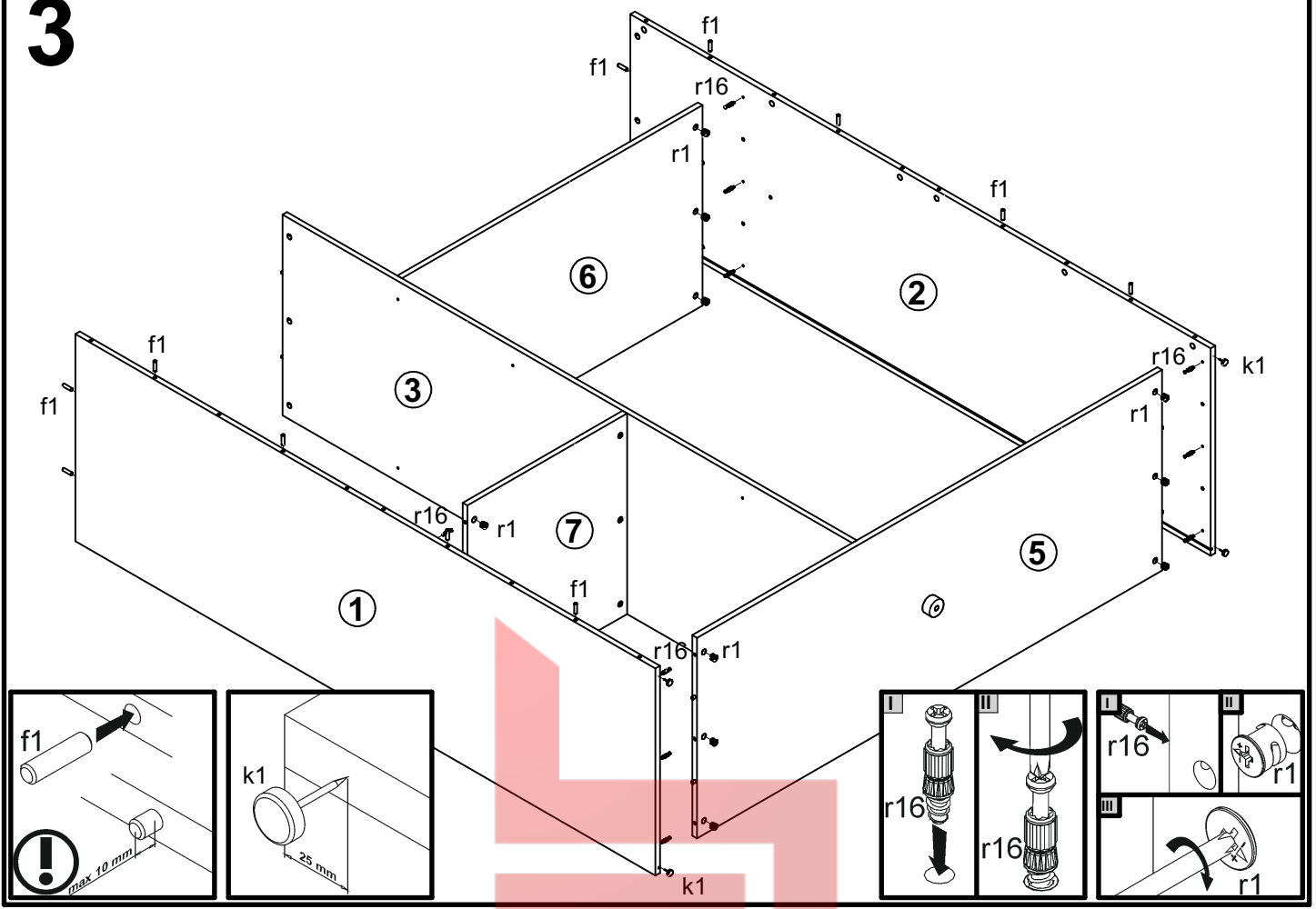

4

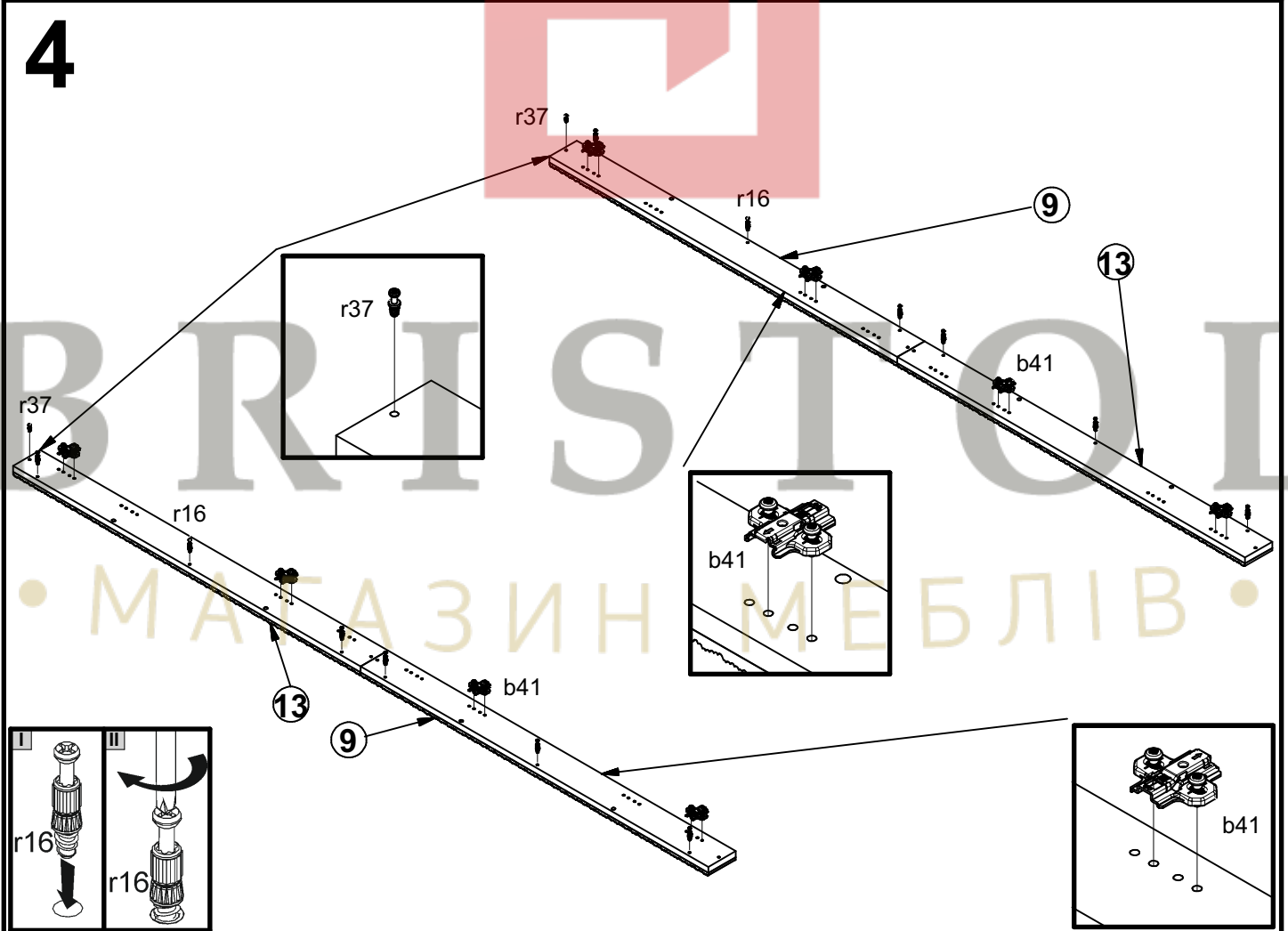

5

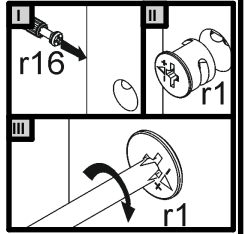
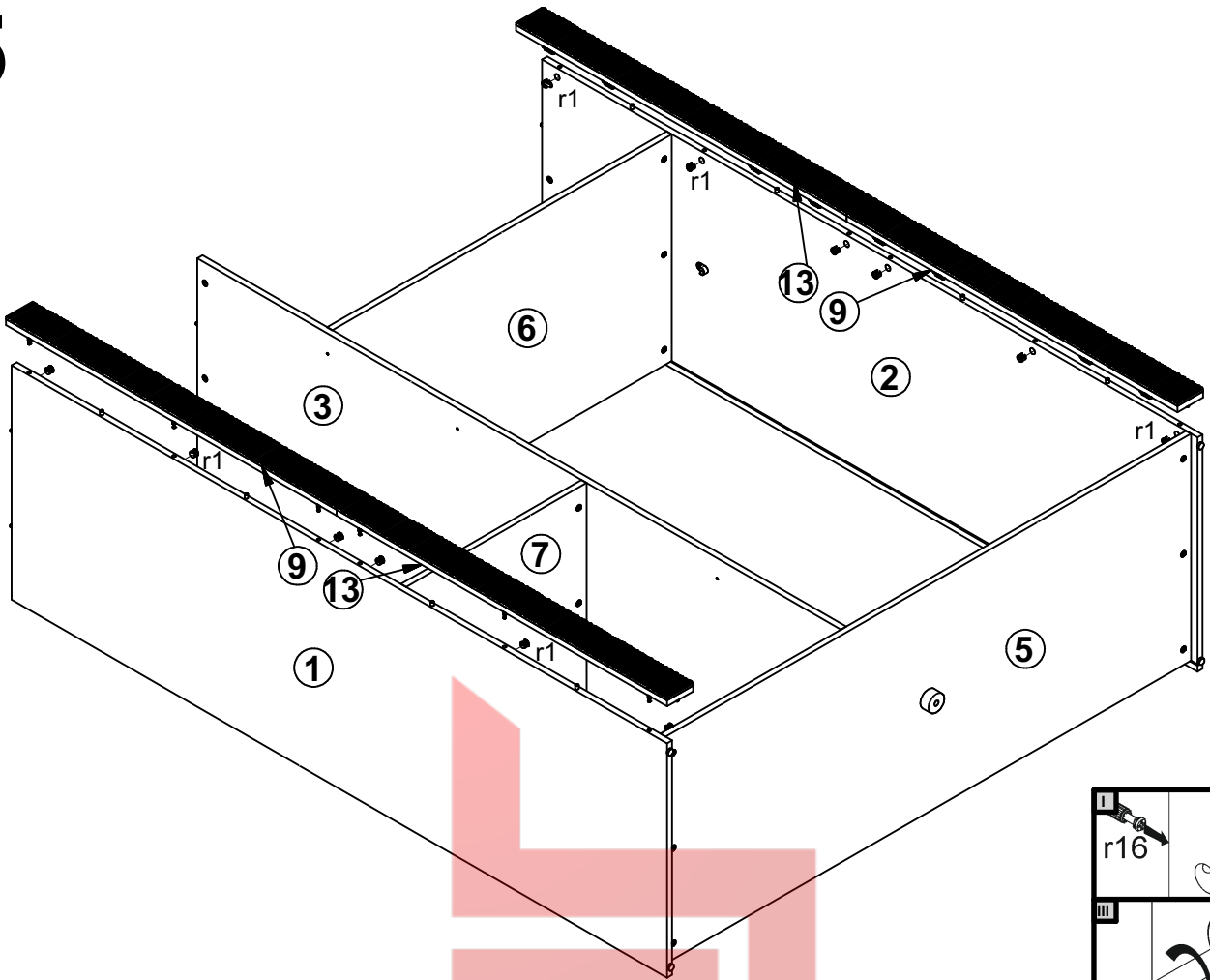

6

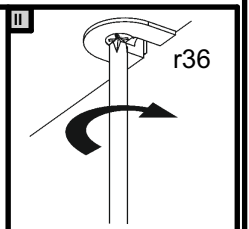
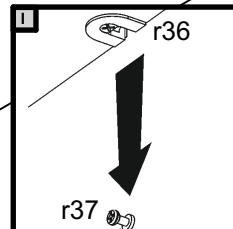
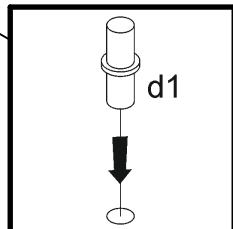
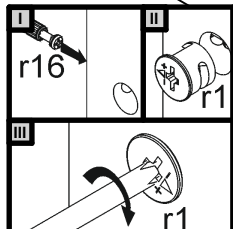
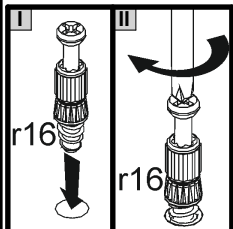
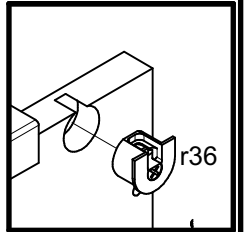
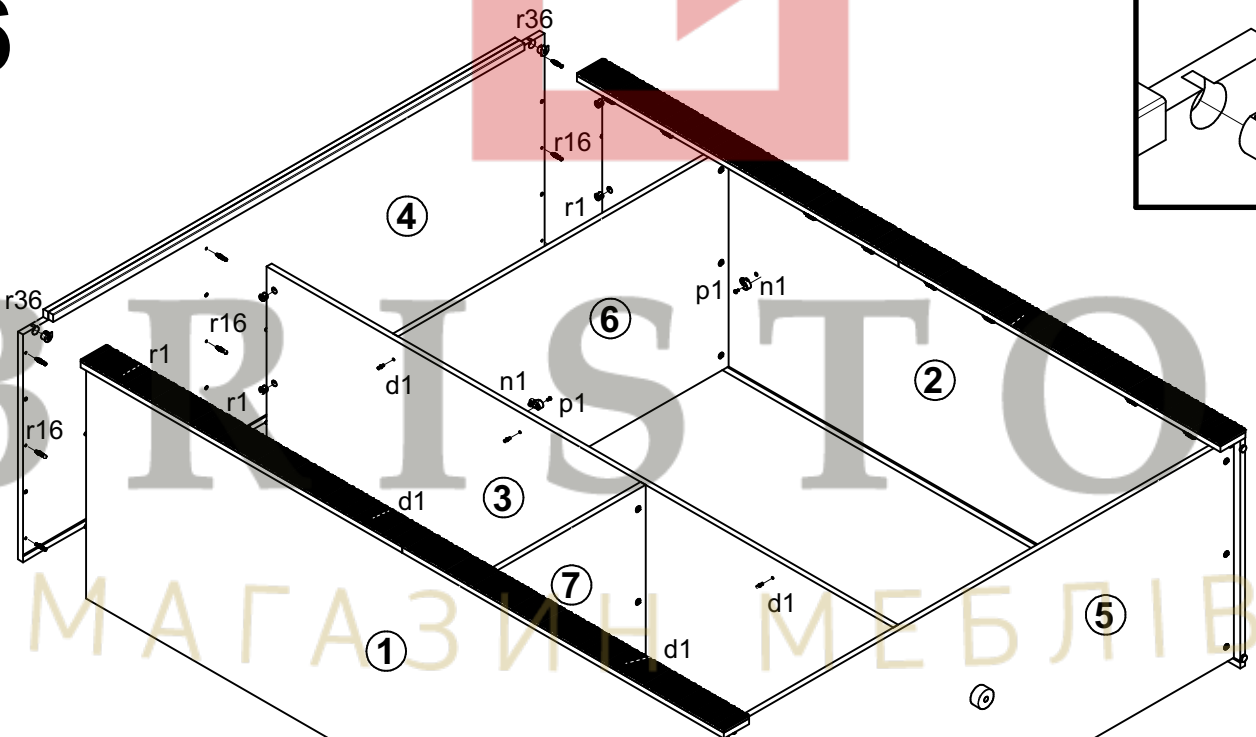

7

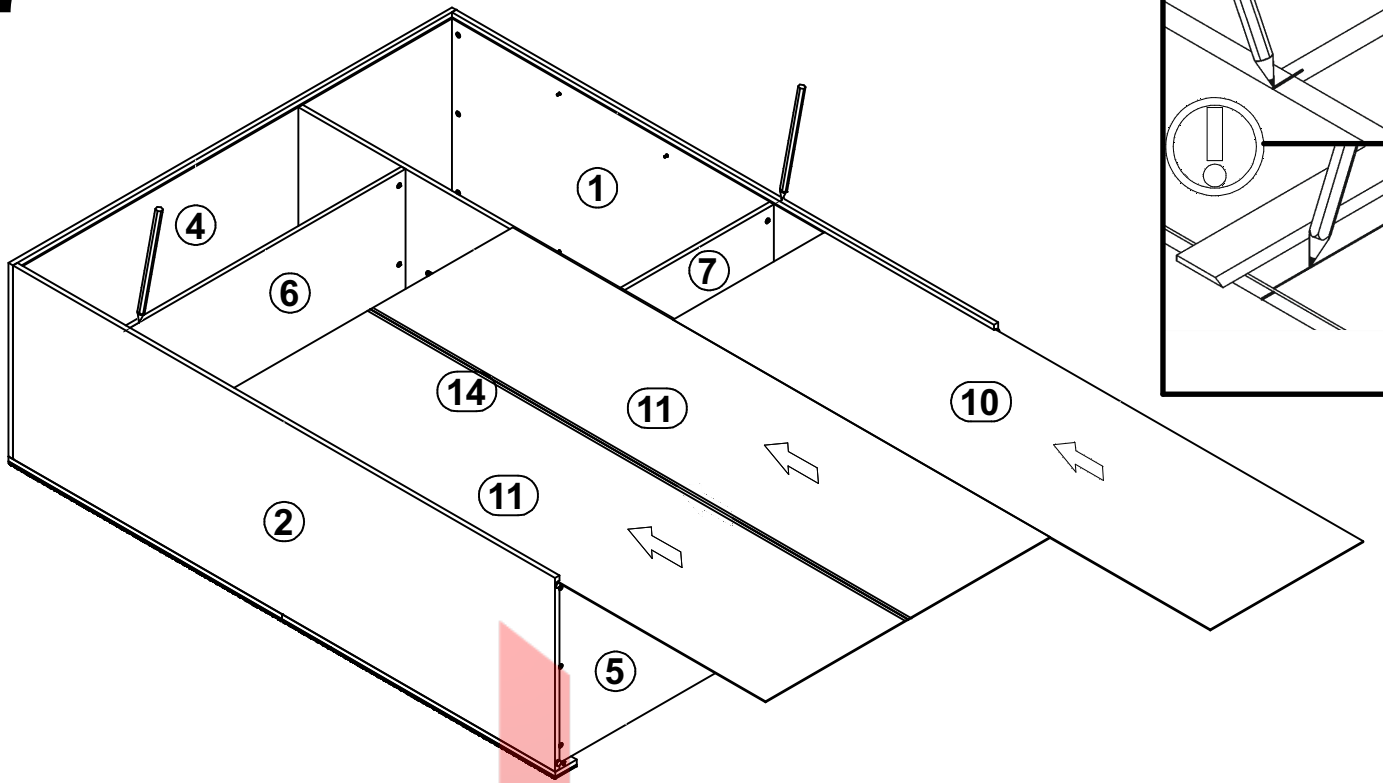

8

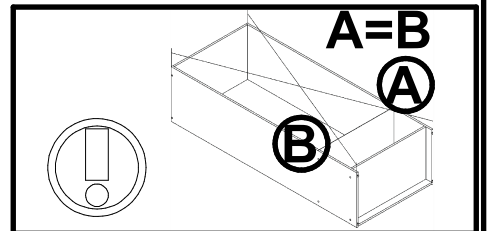
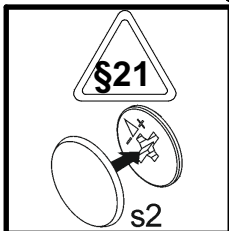
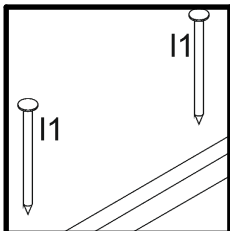
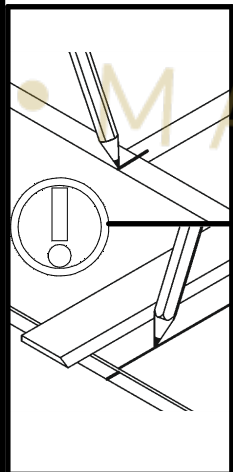
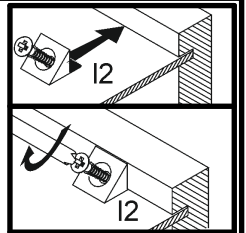
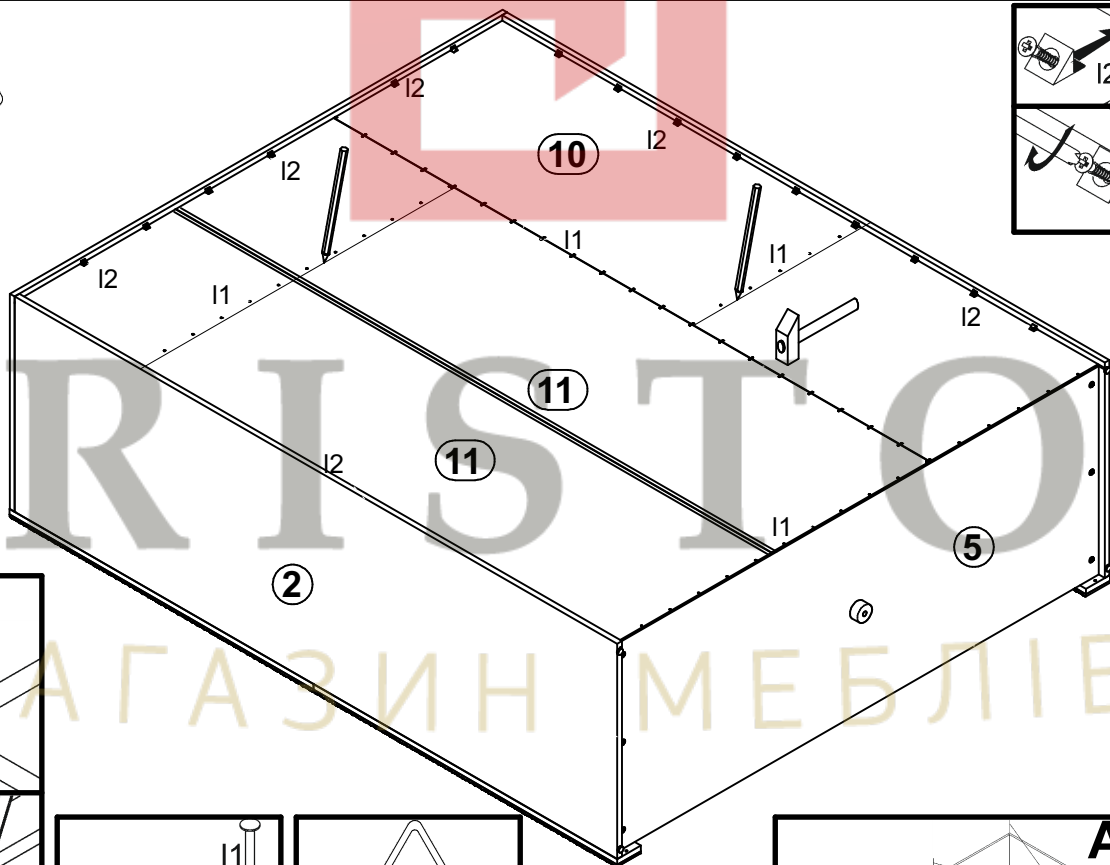

RAFLO

S126-SZF3D/22/17

A	B	C	D
1	S126-040	2089	496
2	S126-041	2089	496

