

RAFLO

S126-SZF3D/21/17

A	B	C	D
1	S126-012	1989	496
			4/4

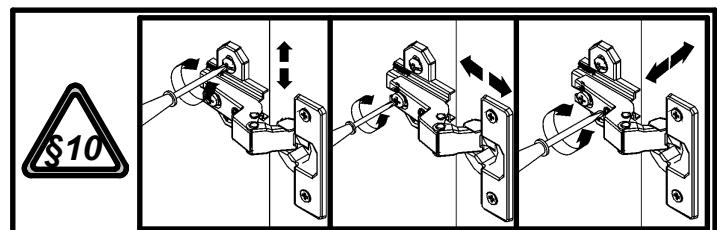
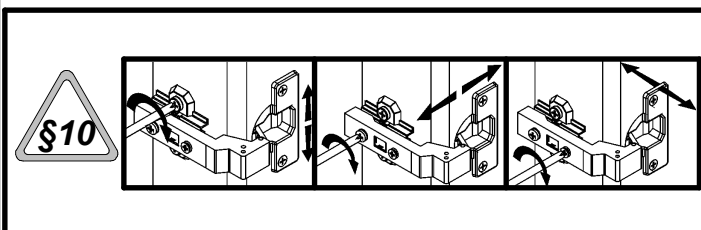
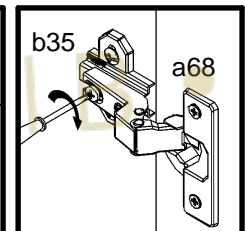
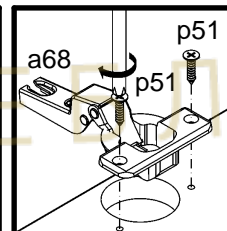
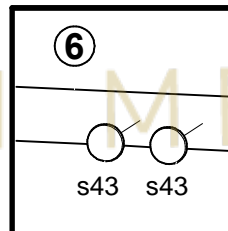
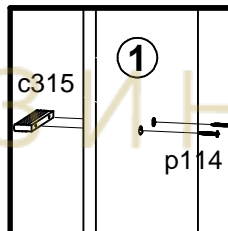
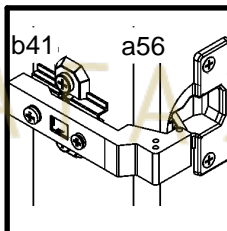
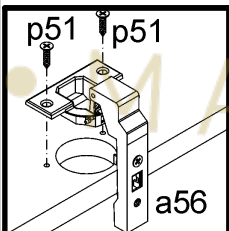
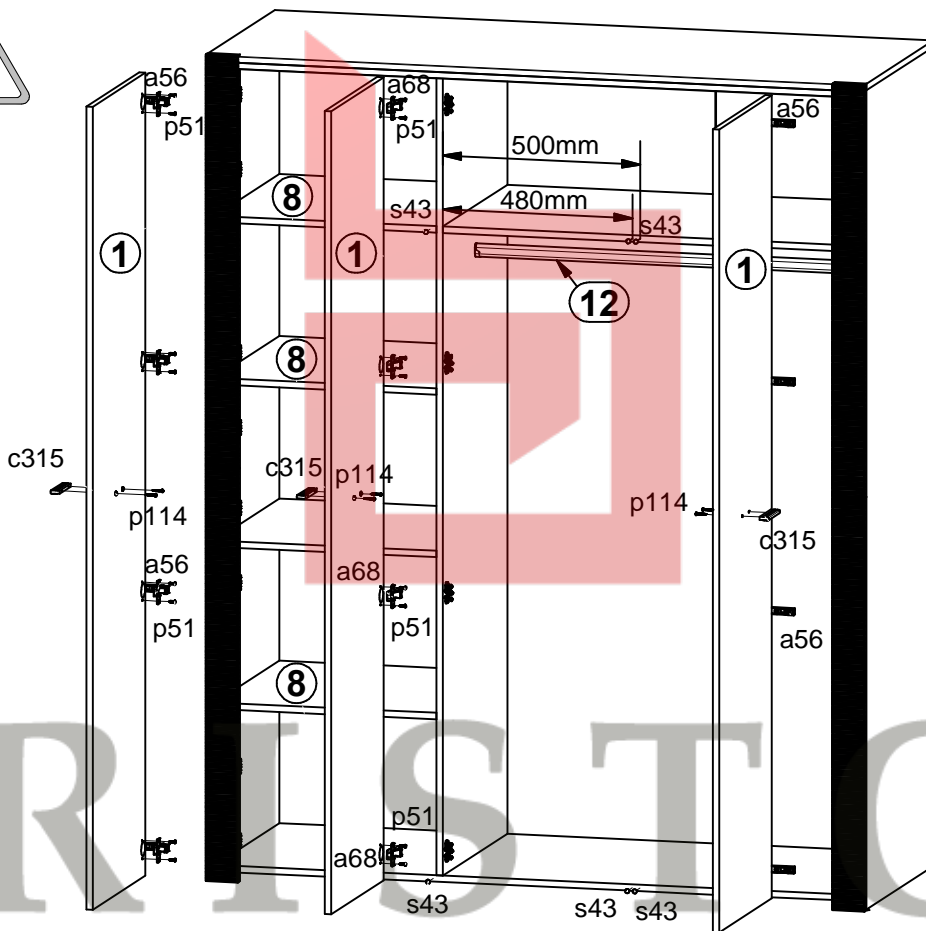
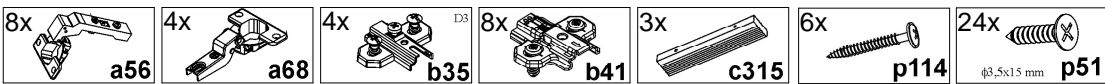
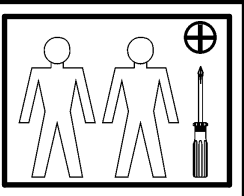
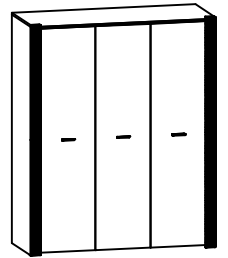
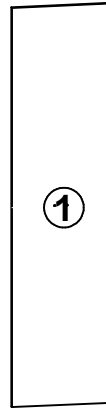

RAFLO

S126-SZF3D/21/17

A	B	C	D	
1	S126-134	2030	629	1/4
2	S126-135	2030	629	1/4
3	S126-136	1994	609	2/4
4	S126-209	1660	651	2/4
5	S126-313	1627	609	2/4
6	S126-316	1052	609	3/4
7	S126-317	559	609	3/4
8	S126-318	559	609	3/4
9	S126-579	1024	80	3/4
10	S126-910	2012	572	1/4
11	S126-9907	2012	1065	1/4
12	dr-1046	1046	30	3/4

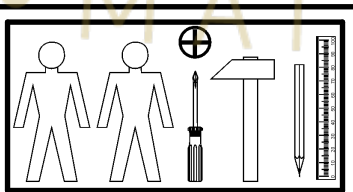
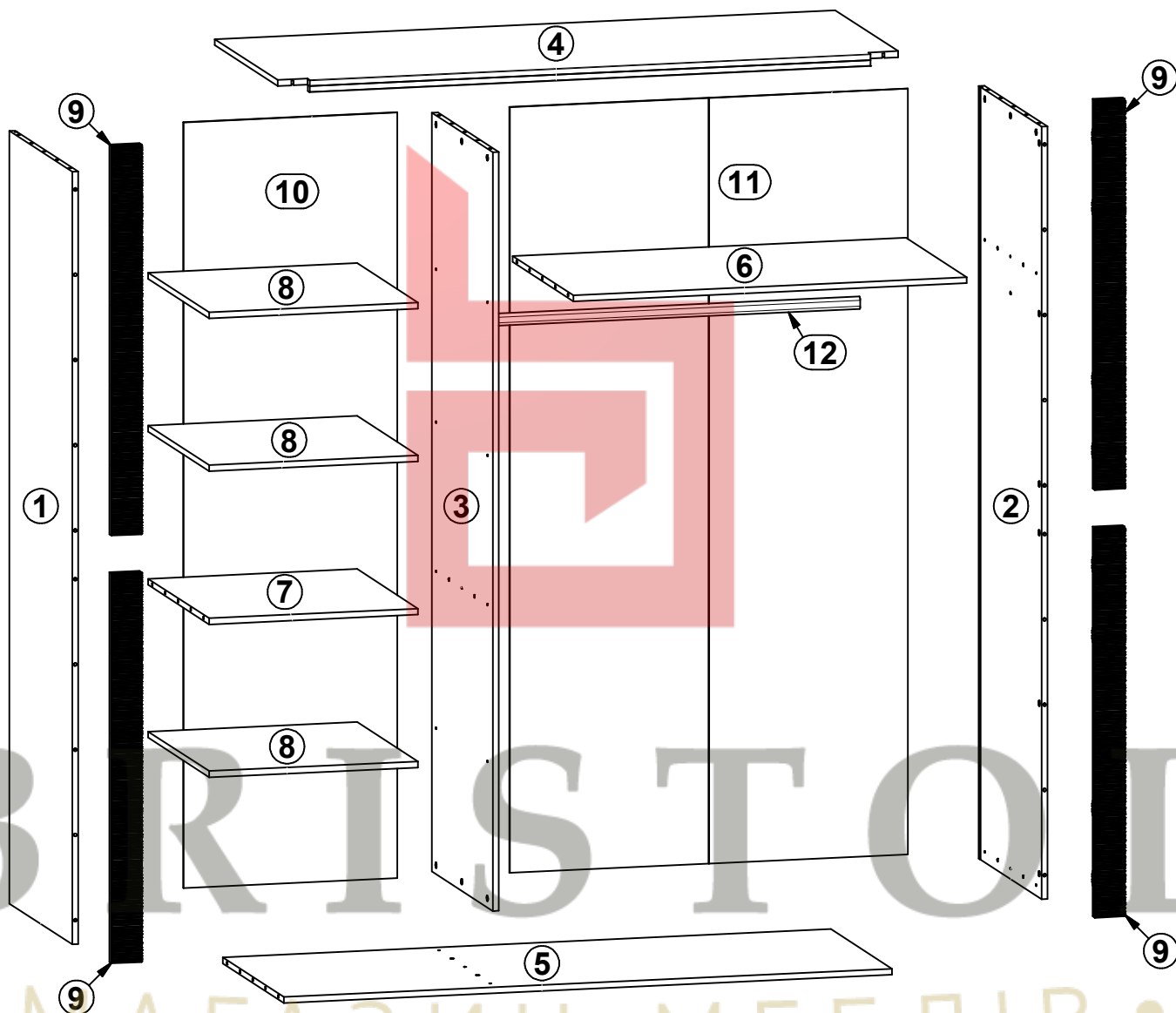
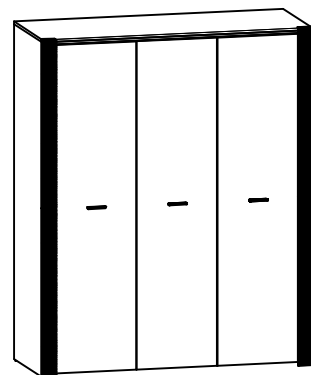

12x φ5x17 mm d1	28x φ8x30 mm f1	4x k1	1x k53	70x l1	24x l2	2x n1	2x φ3,5x13 mm p1	1x φ4x25 mm p36
42x φ15x12mm #16 r1	42x r16	2x φ20x12mm #16 r36	2x 6,7/7,8 r37	30x φ16 s2	6x φ11x5 mm s43	1x n26\1	1x φ3,5x16 mm p38	

1

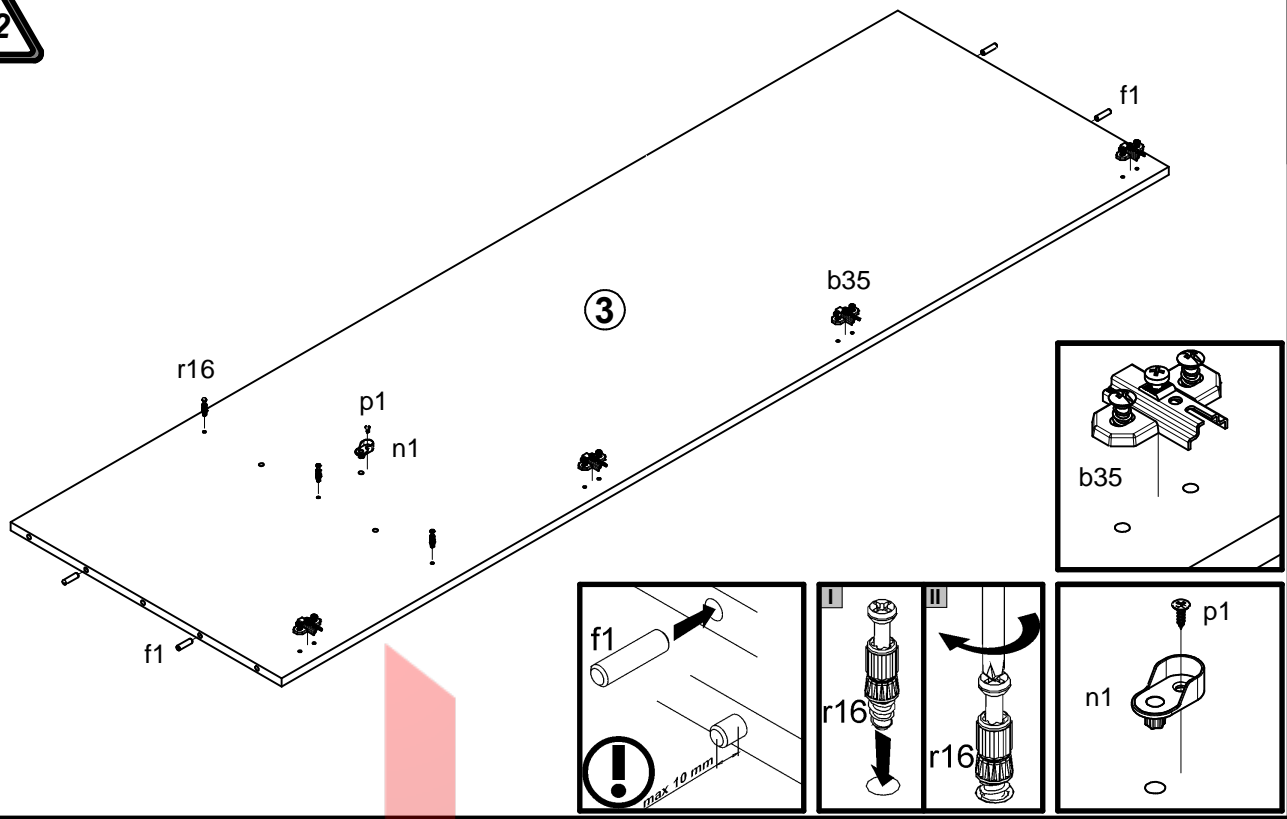

2

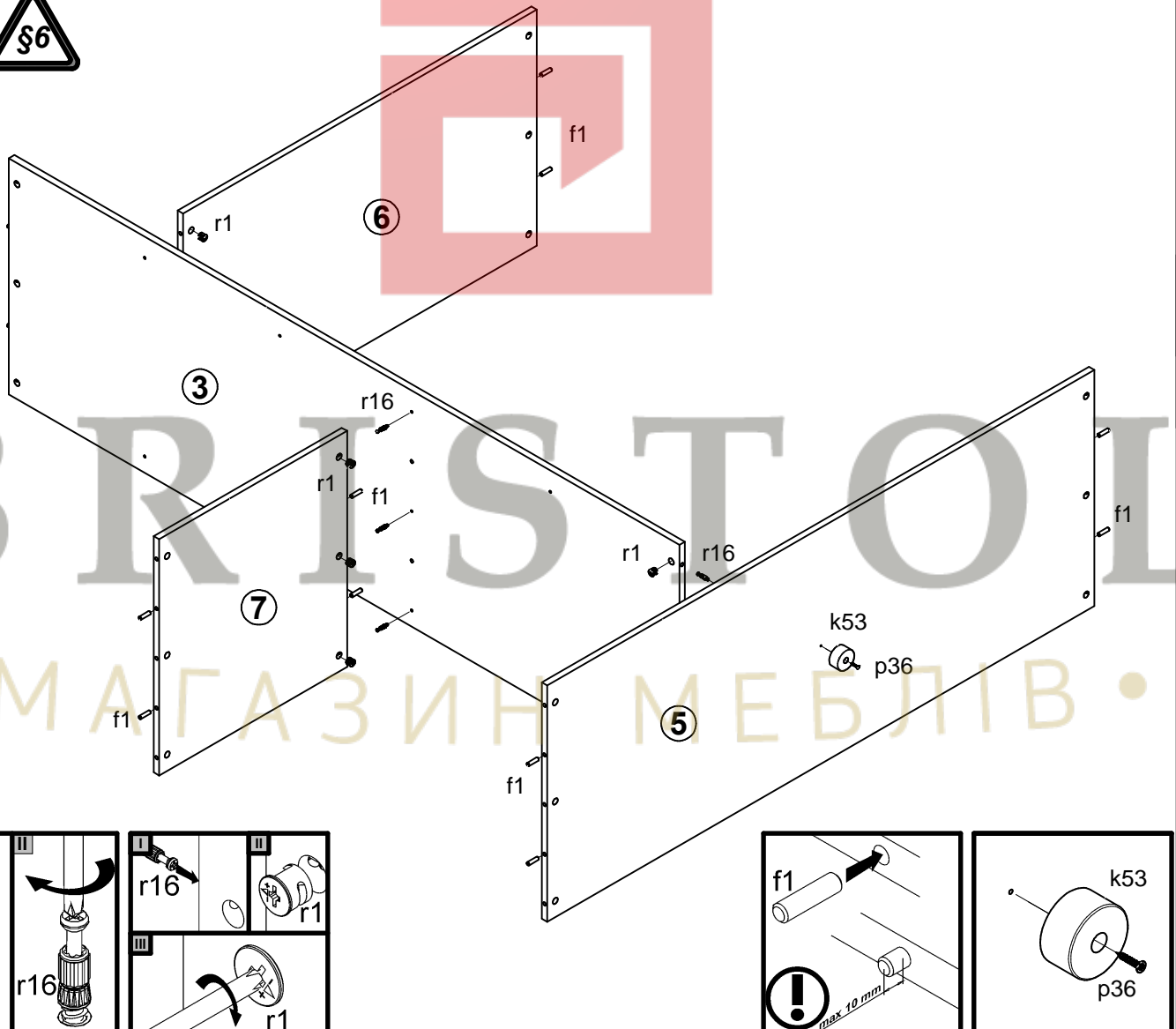

3

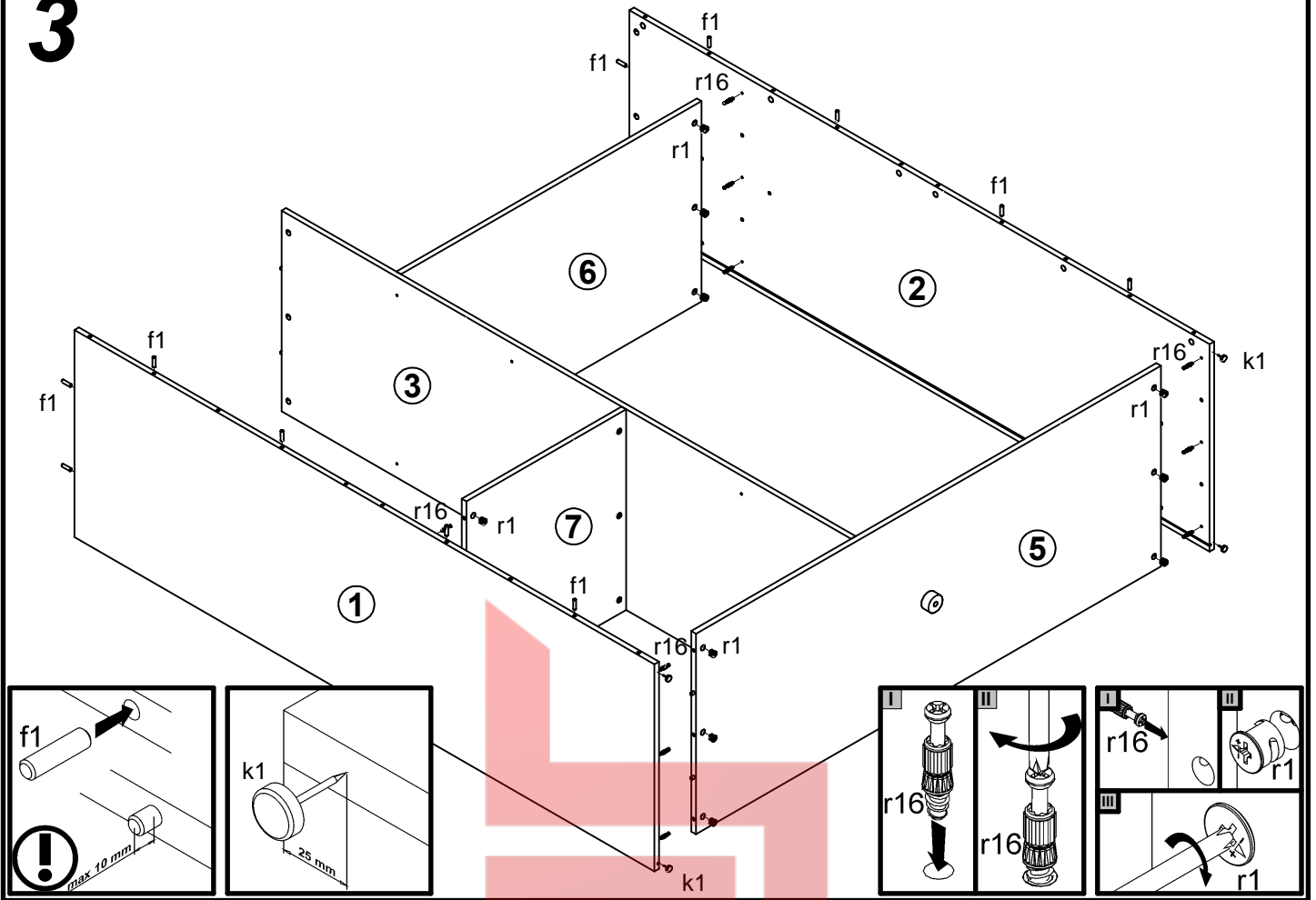

4

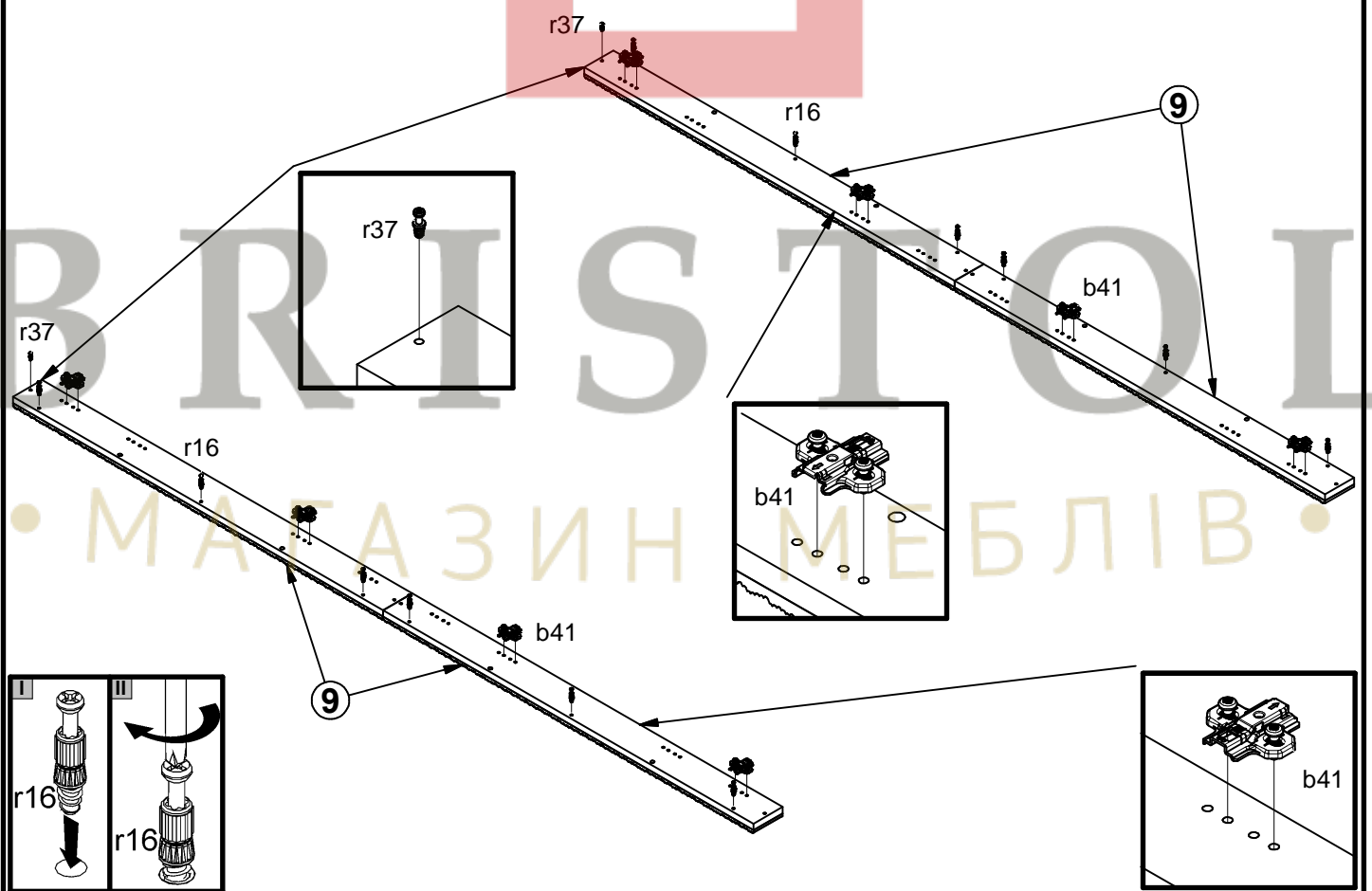

5

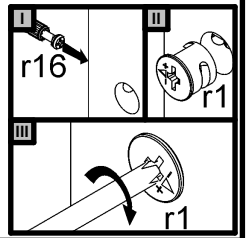
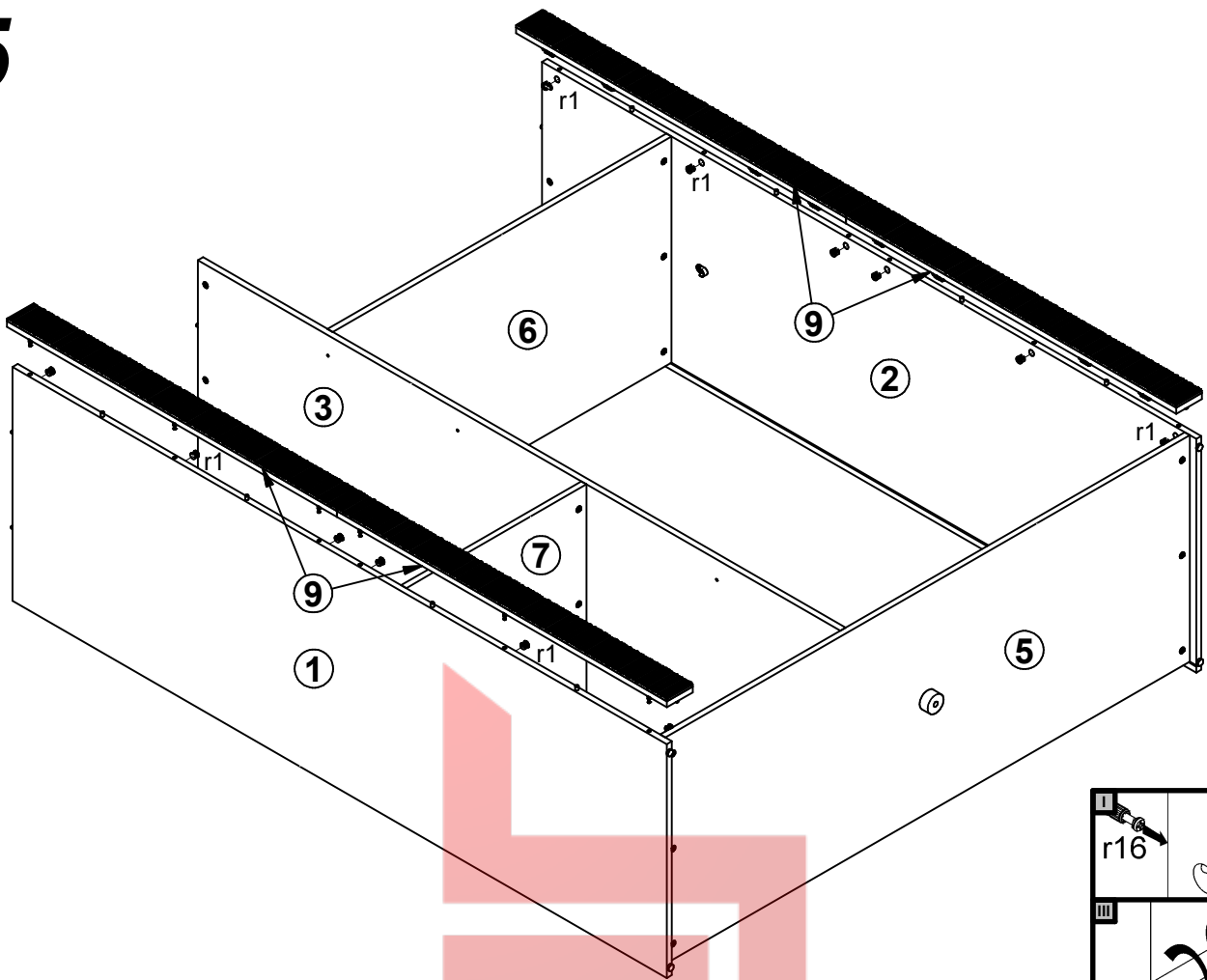

6

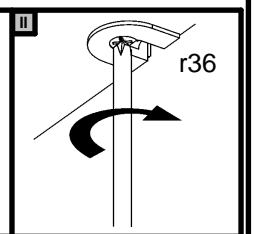
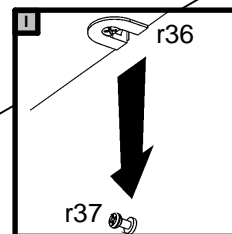
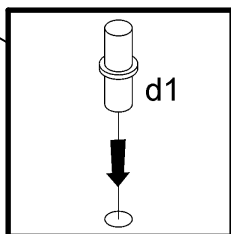
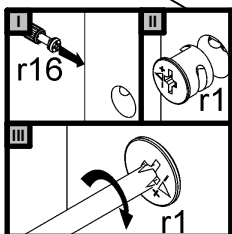
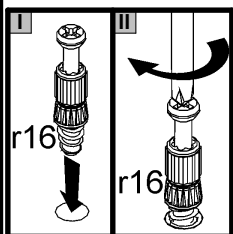
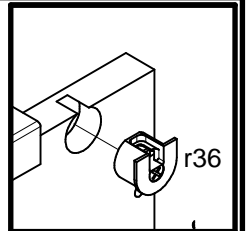
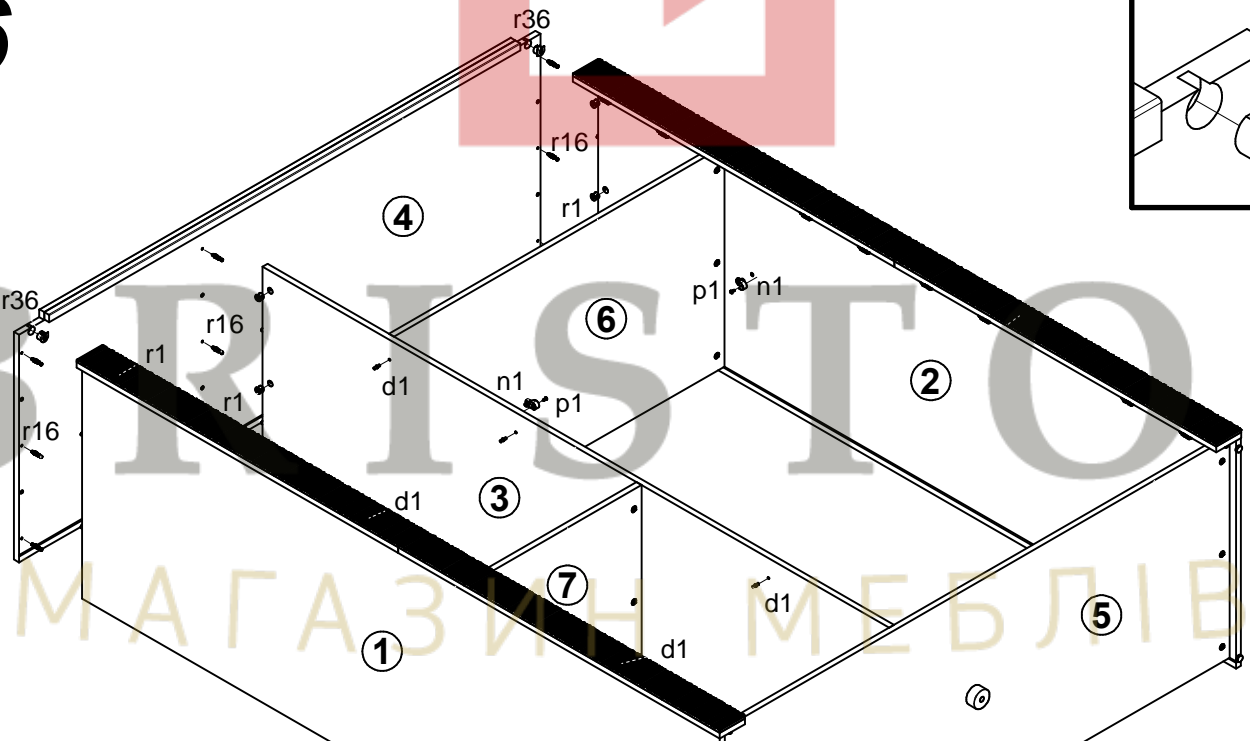

7

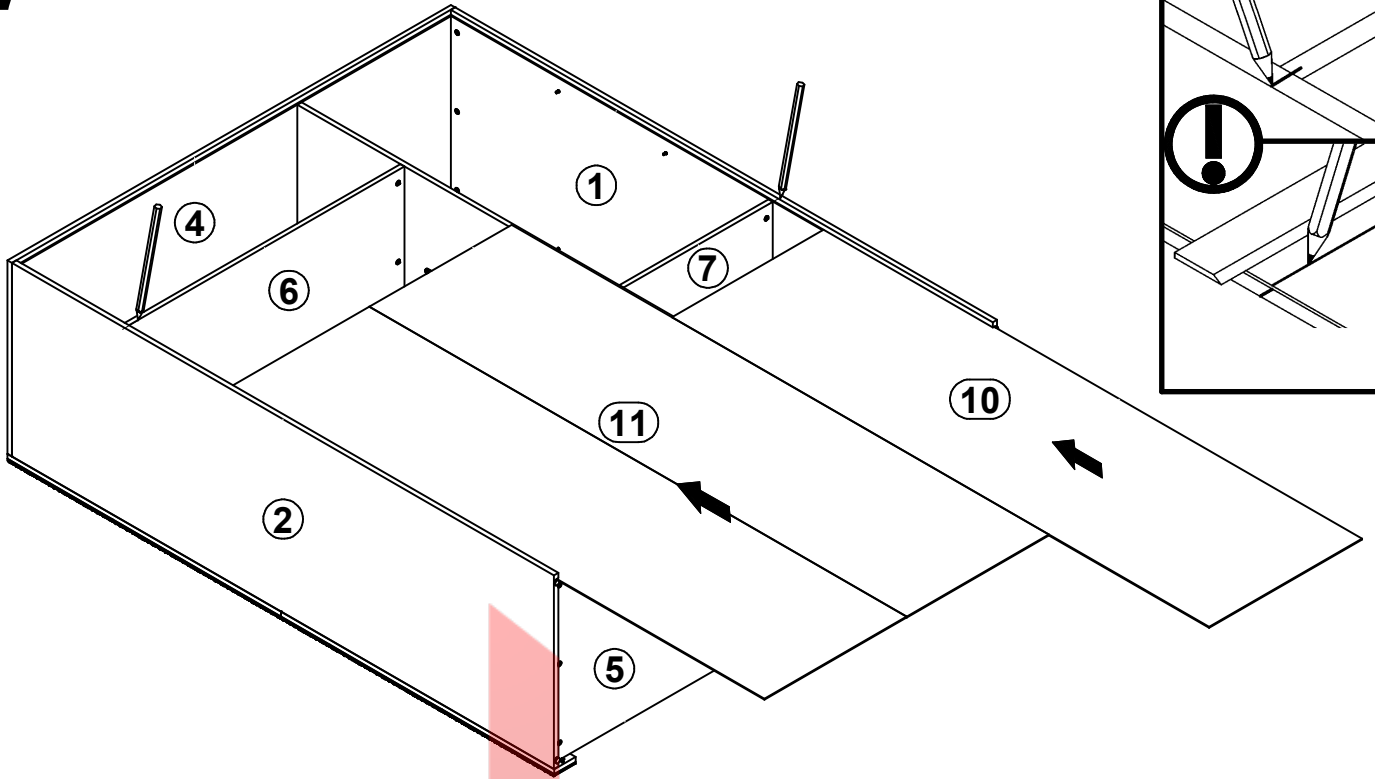

8

