

RAFLO

S126-SZF4D/22/22

A	B	C	D
1	S126-170	2130	629
2	S126-171	2130	629
3	S126-172	2094	609
4	S126-230	2160	651
5	S126-350	2127	609
6	S126-351	977	609
7	S126-317	559	609
8	S126-318	559	609
9	S126-590	1074	80
10	S126-971	2112	572
11	S126-970	2112	496
12	dr-972	972	30
13	lh-2082	2082	14
14	S126-173	2094	609
15	S126-592	1074	80

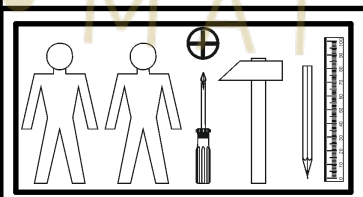
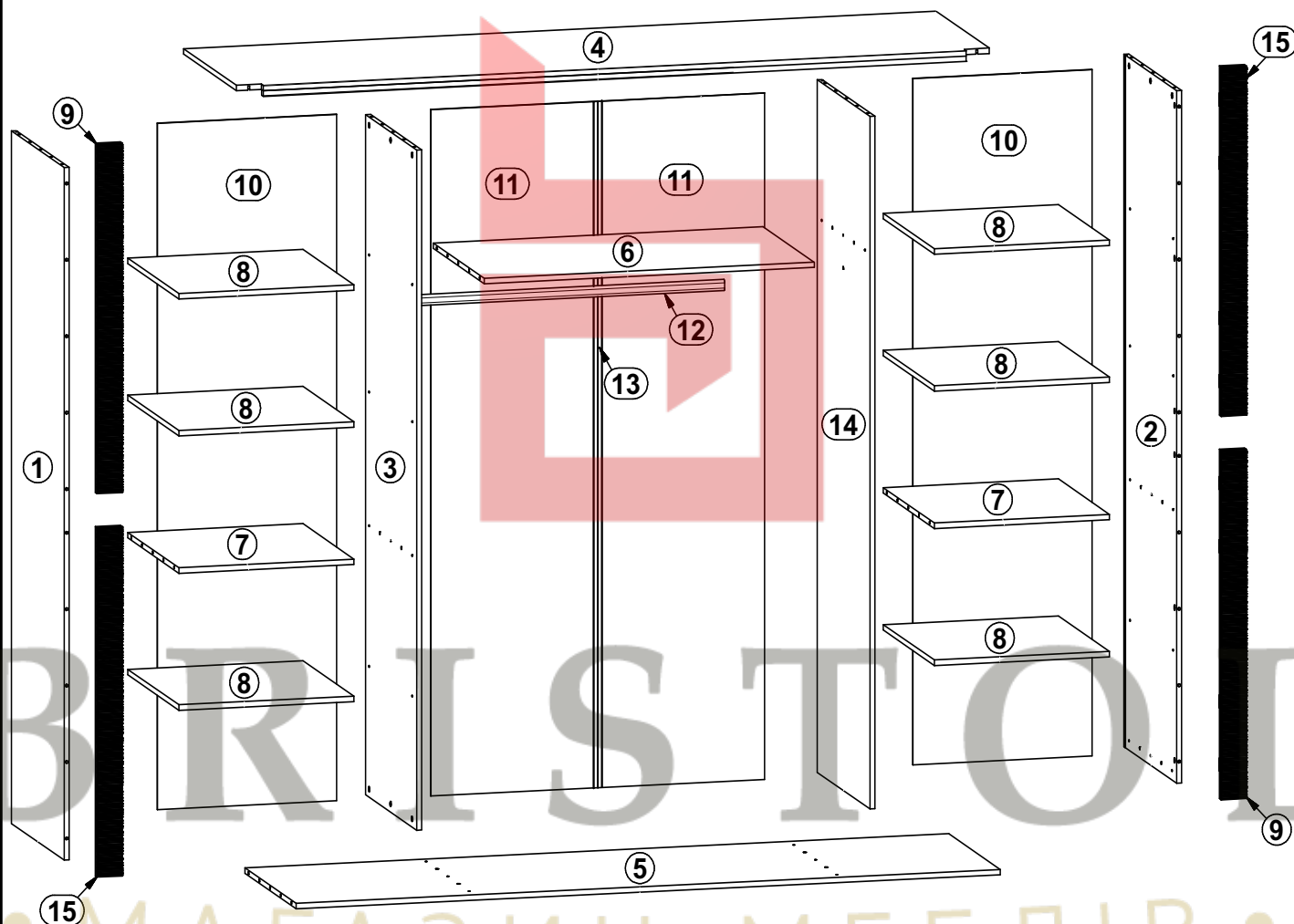
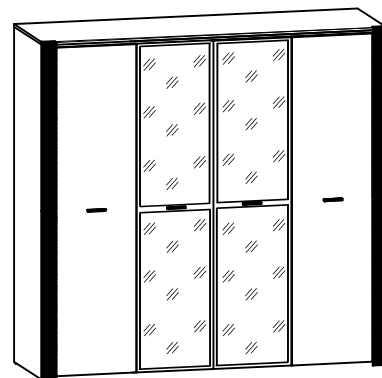

24x φ5x17 mm d1	36x φ8x30 mm f1	4x k1	2x k53	100x l1	26x l2	2x n1	2x φ3,5x13 mm p1	2x φ4x25 mm p36
54x φ15x12mm #16 r1	54x r16	2x φ20x12mm #16 r36	2x 6,7x8 r37	42x ø16 s2	8x φ11x5 mm s43	1x n2611	1x φ3,5x16 mm p38	

1

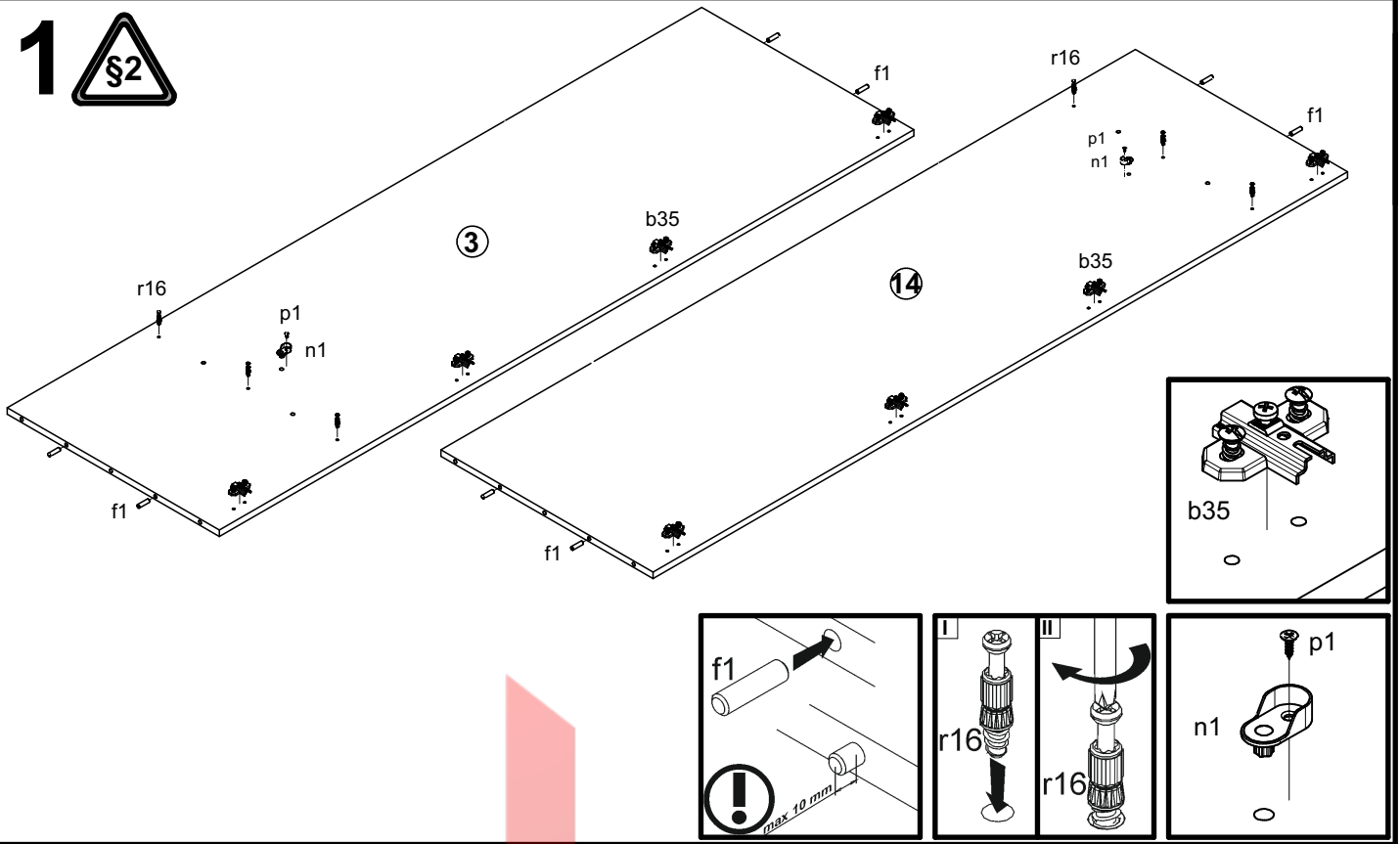

2

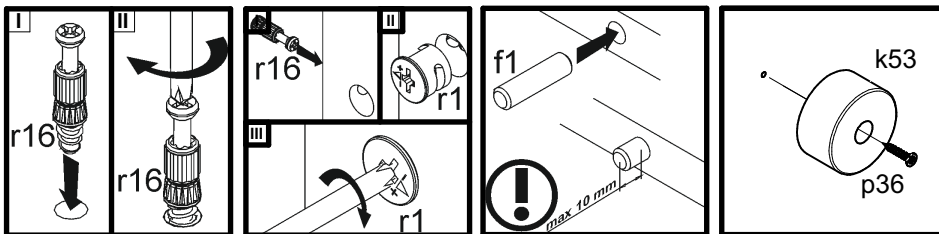
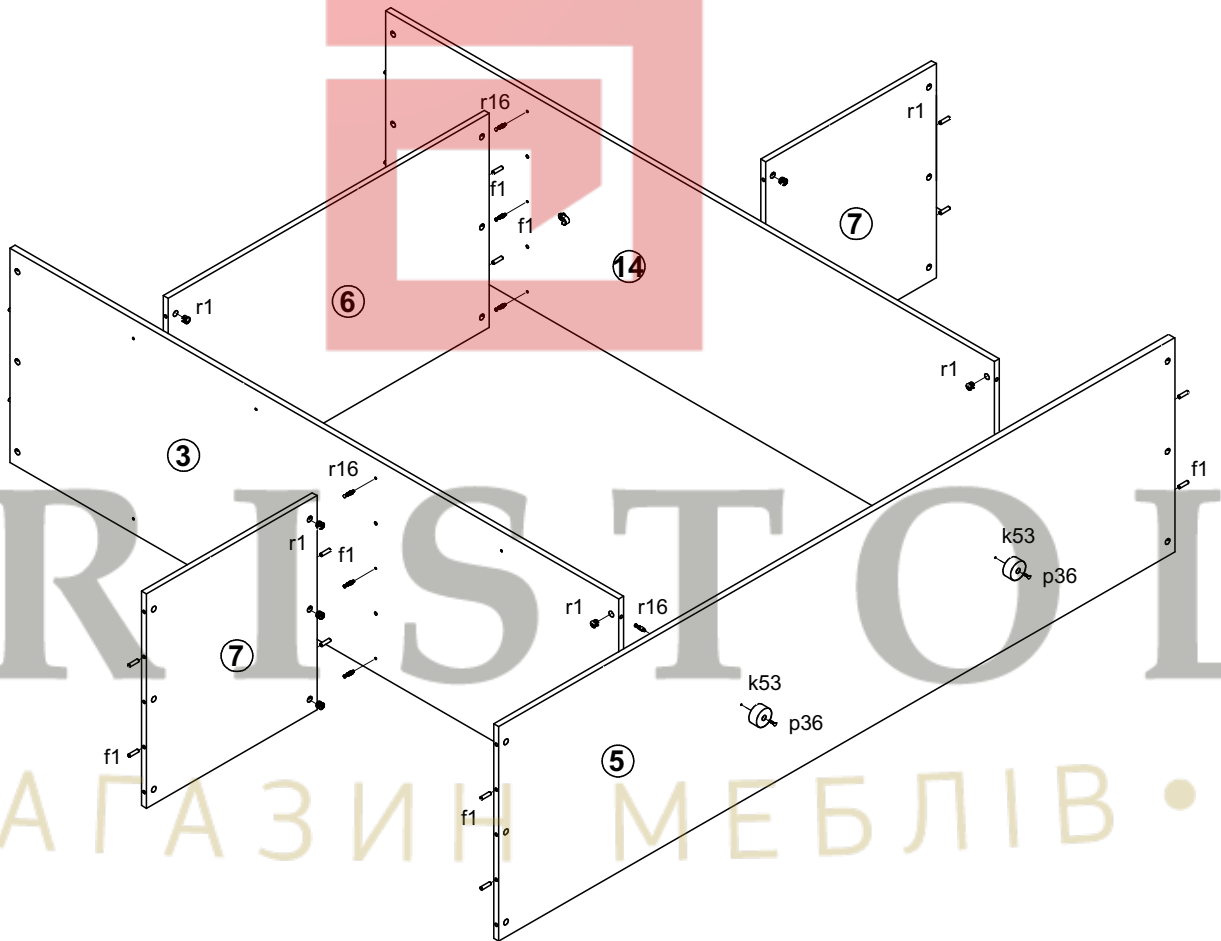

3

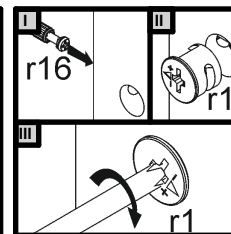
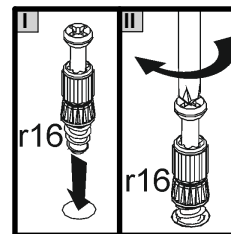
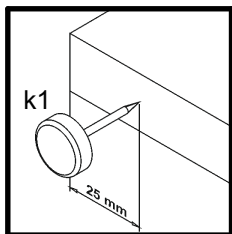
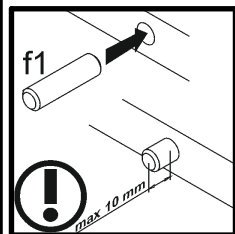
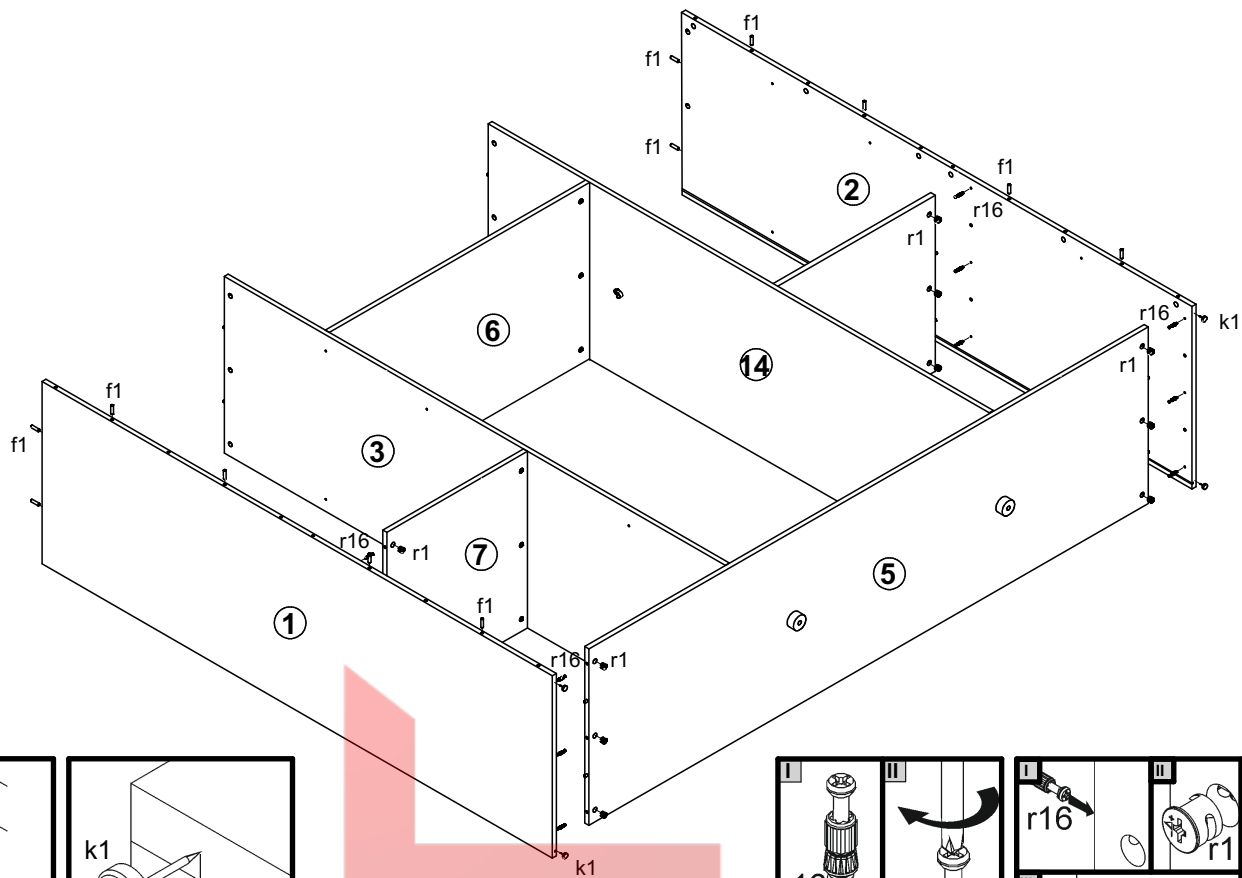

4

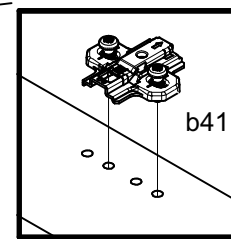
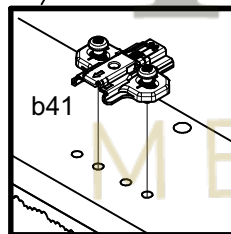
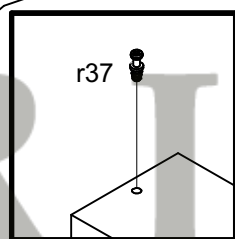
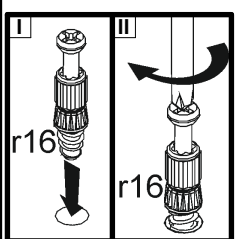
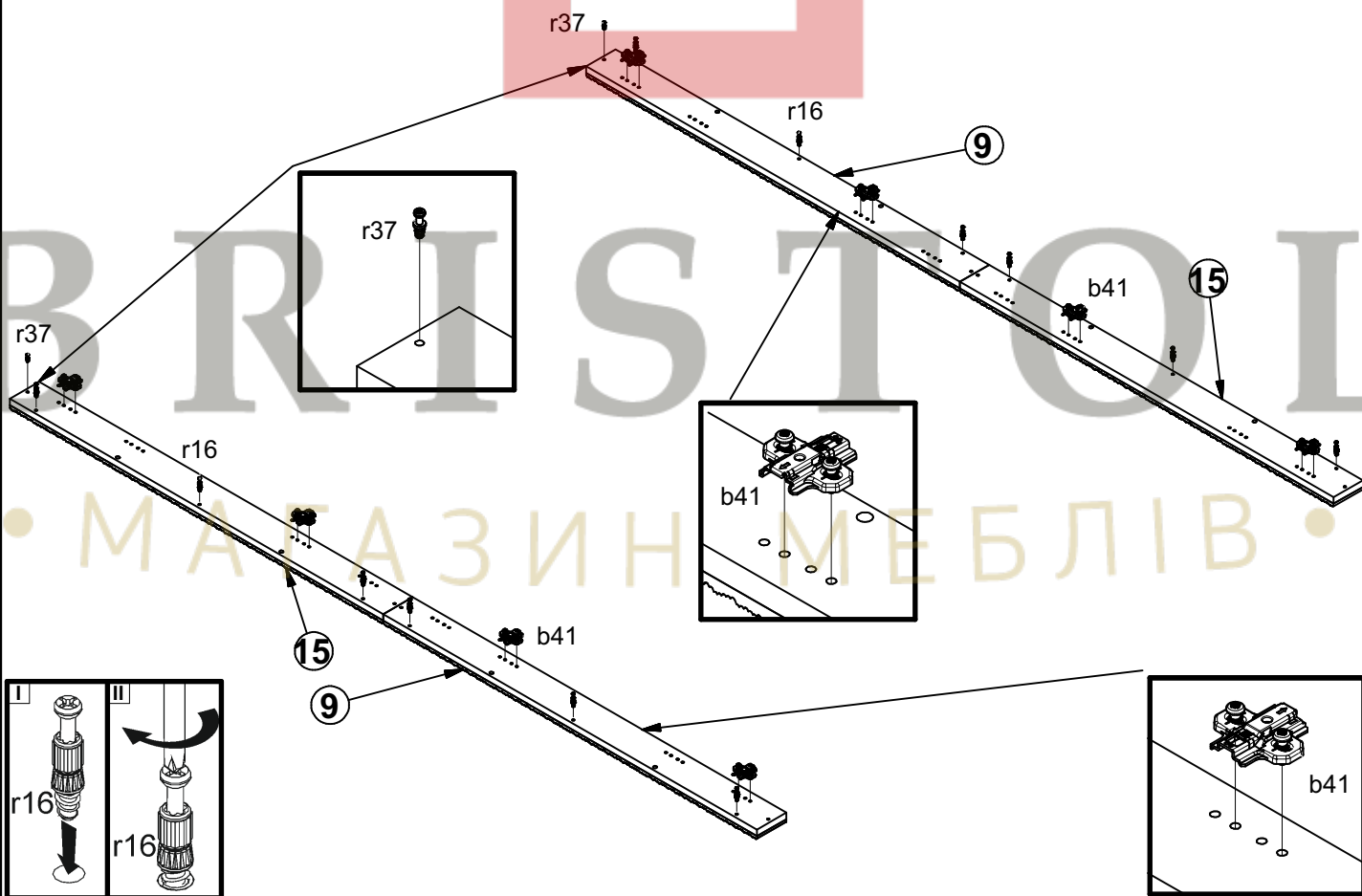

5

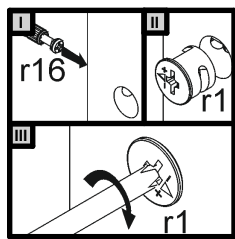
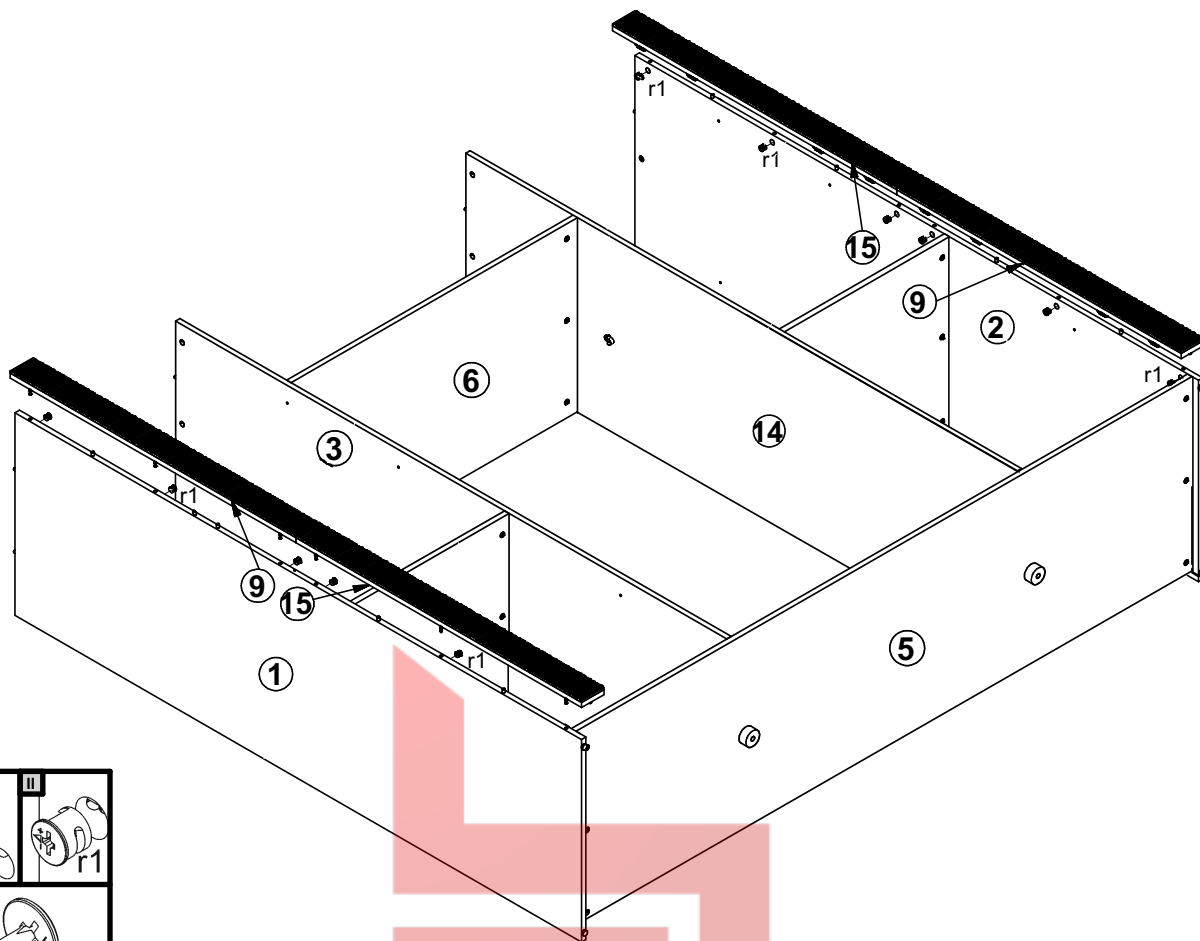

6

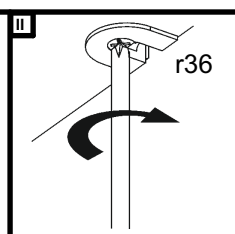
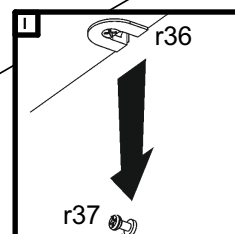
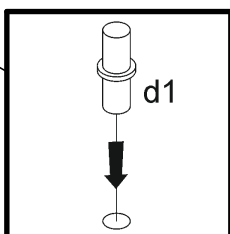
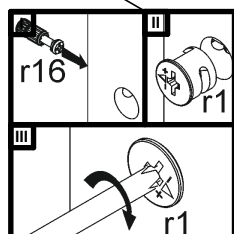
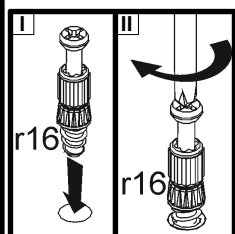
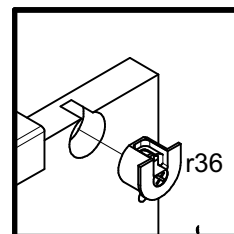
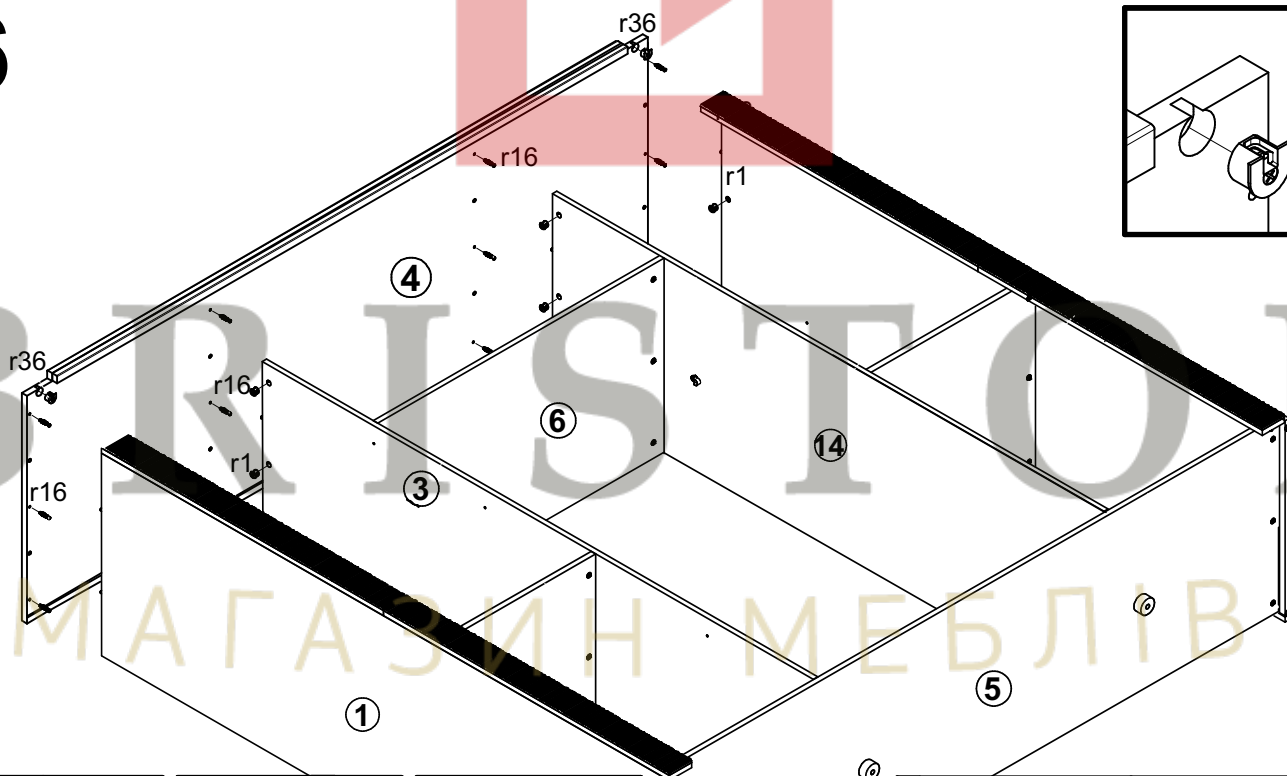

7

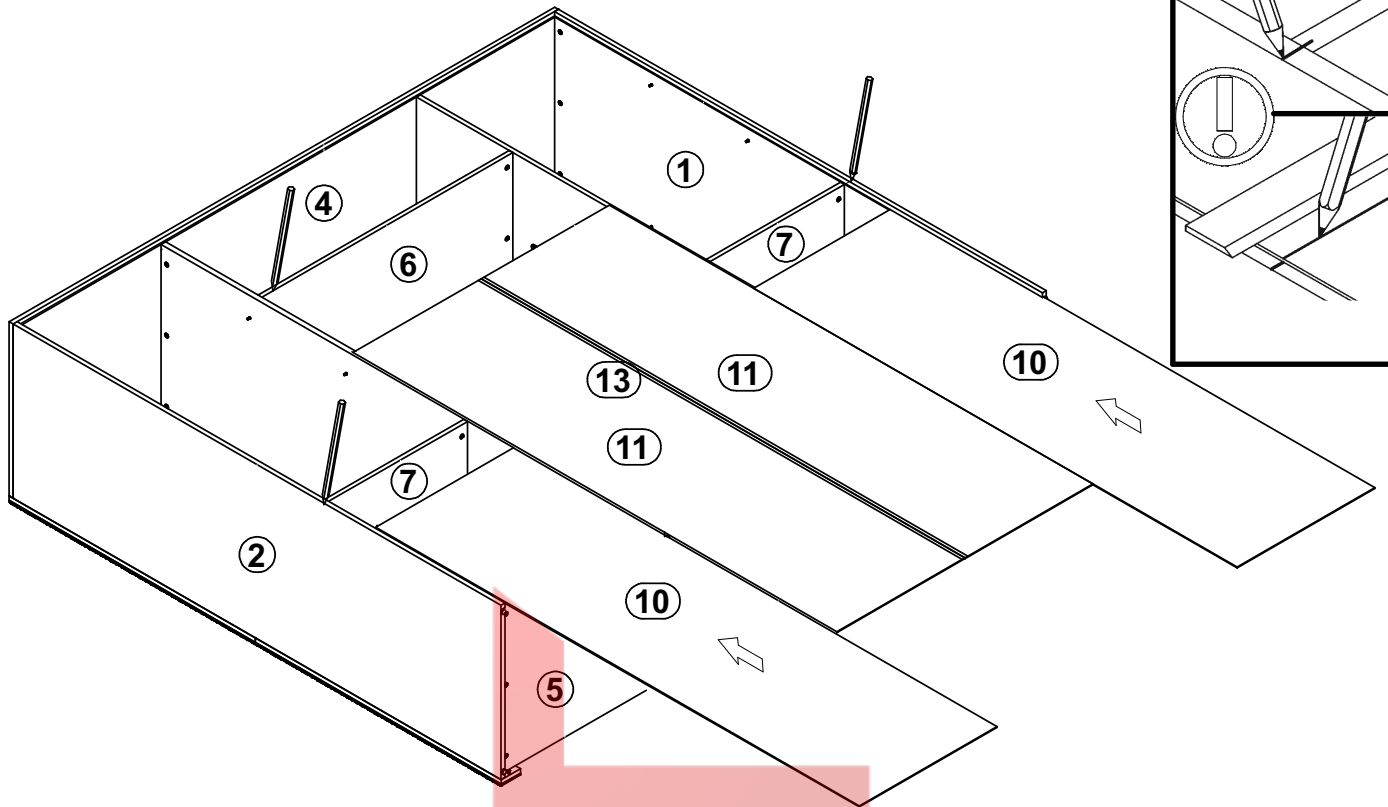

8

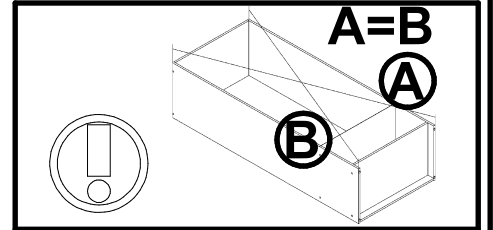
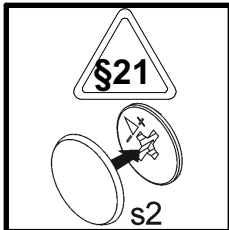
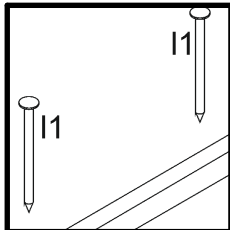
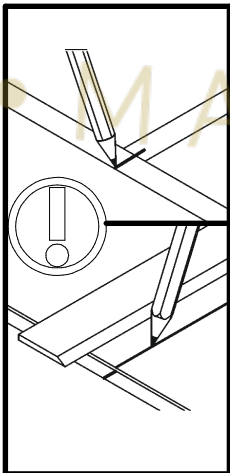
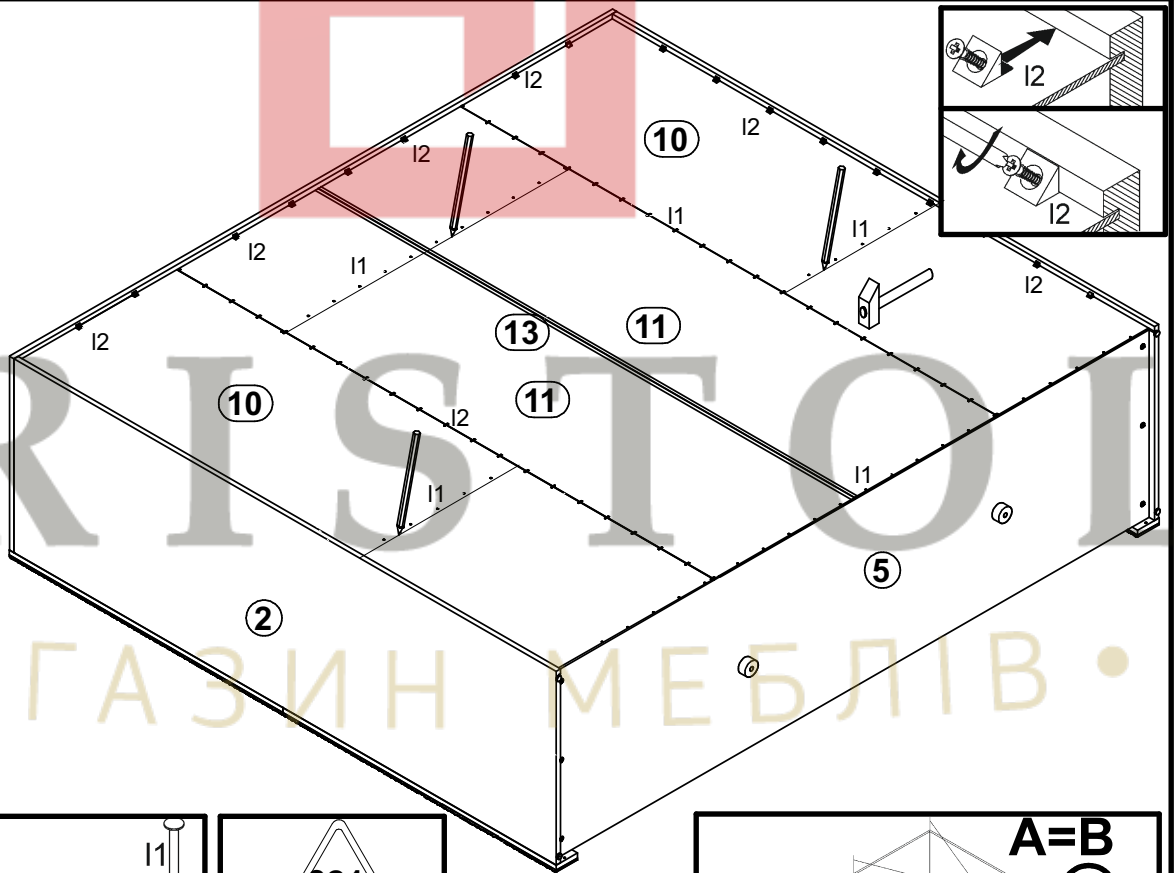

RAFLO

S126-SZF4D/22/22

A	B	C		D
1	S126-040	2089	496	4/5
2	S126-041	2089	496	5/5

