

SETI

S135-KOM4S

A	B	C	D	
1	S135-018	723	196	3/3
2	S135-131	880	330	1/3
3	S135-146	880	330	1/3
4	S135-347	729	305	2/3
5	S135-348	765	305	2/3
6	S135-418	765	80	2/3
7	S135-922	691	298	2/3
8	S135-923	794	795	1/3
9	ZS2-507	300	120	2/3
10	ZS2-508	300	120	2/3
11	ZS2-5565	680	120	2/3

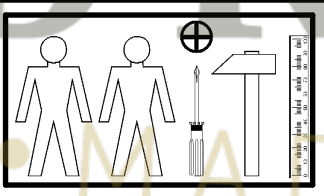
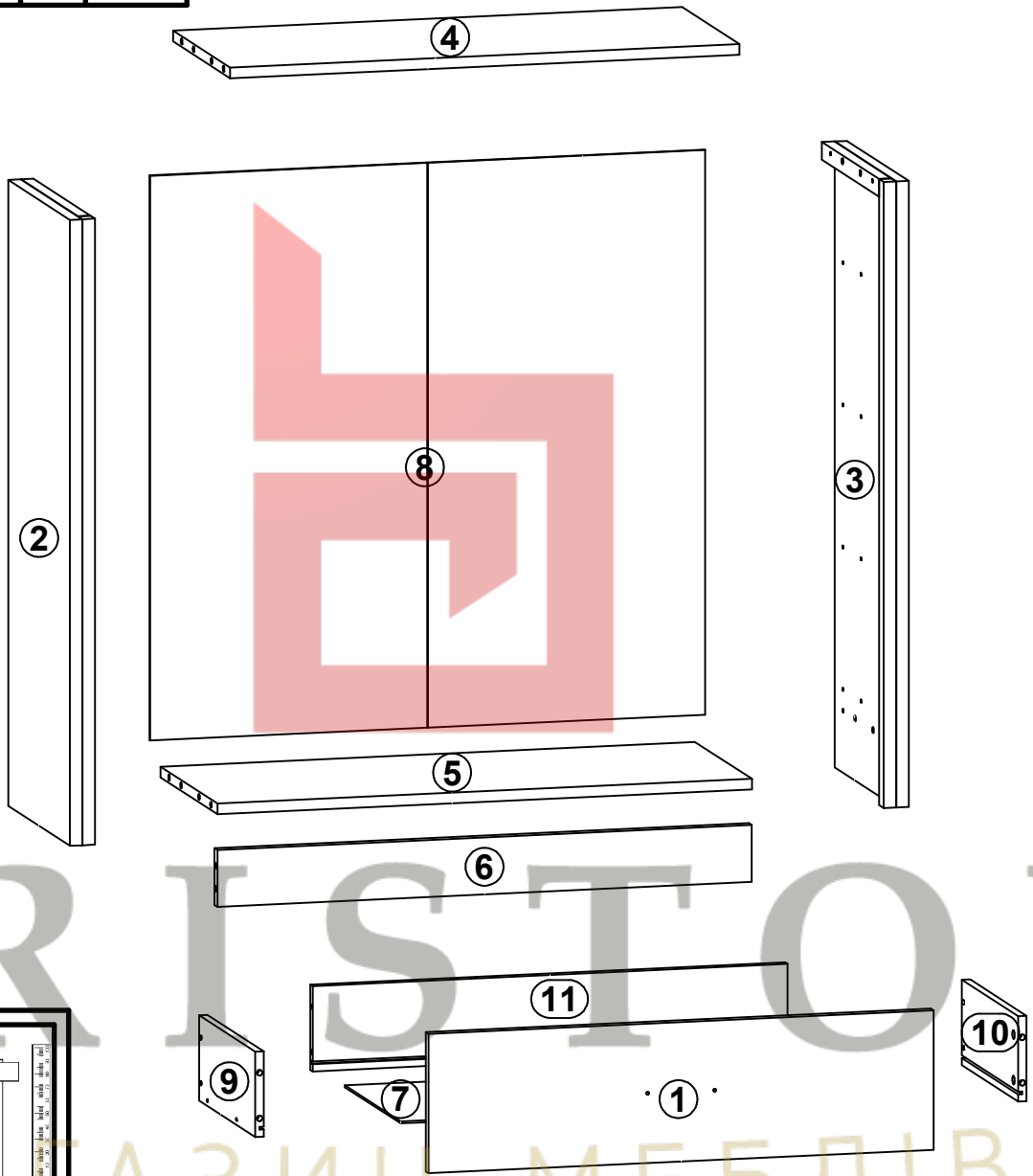

4x L=146/96 c296\3	24x $\phi 6 \times 30$ mm e16	16x $\phi 5 \times 9$ mm e19	12x $\phi 8 \times 30$ mm f1	16x $\phi 6.5 \times 40$ mm f25	4x k1	40x l1	8x $\phi 3.5 \times 16$ mm p25	8x $\phi 2.9 \times 24$ mm p50
8x $\phi 1.5 \times 12$ mm #16 r1	16x $\phi 12 \times 10.5$ mm #12 r15	24x r42	4x 283 mm t18	24x h=18 mm w36	4x 300 mm w37\CL	4x 300 mm w37\CR	4x 300 mm w37\DL	4x 300 mm w37\DR
1x n26\1	1x $\phi 3.5 \times 16$ mm p38							

1 

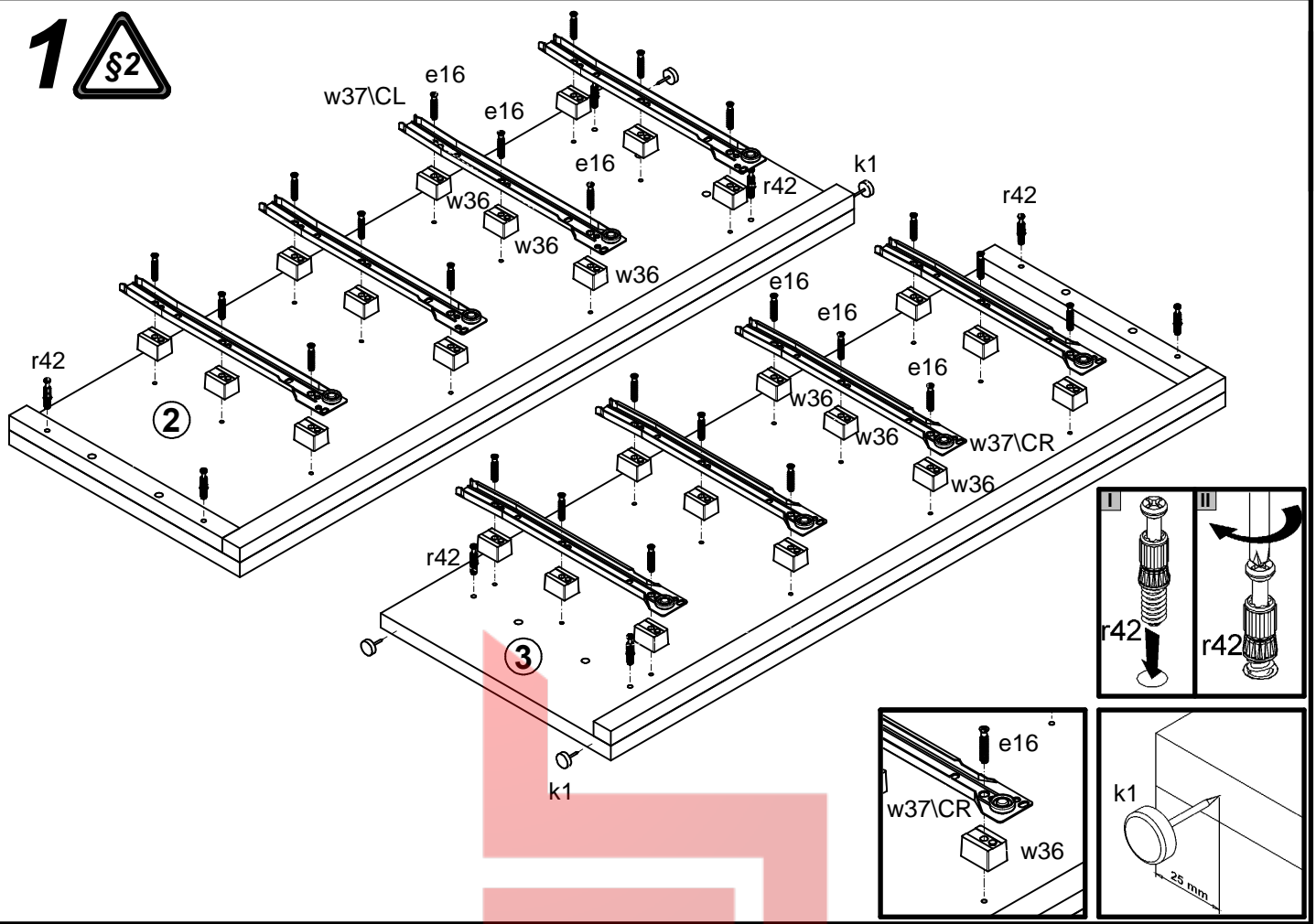

2 

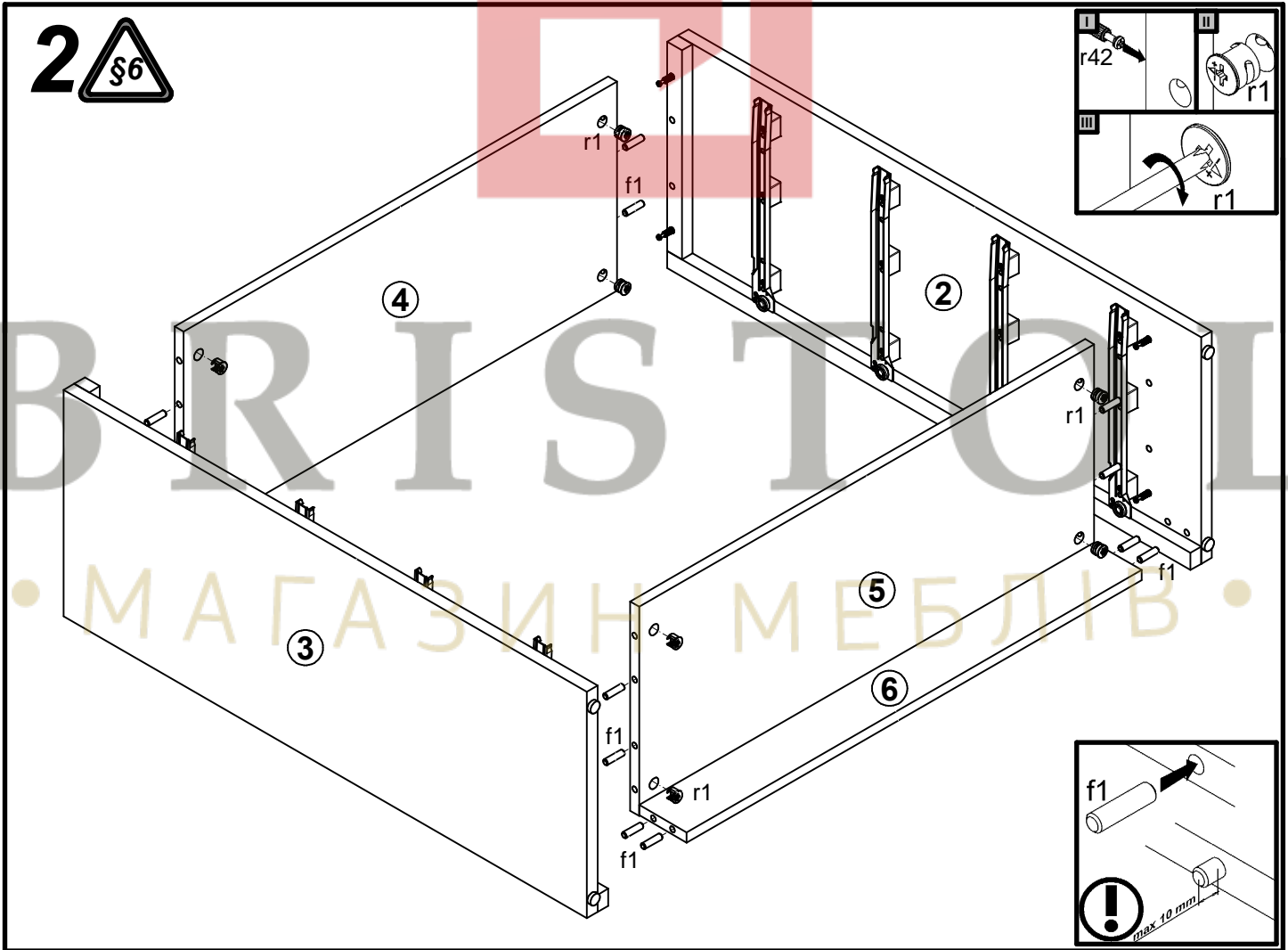

3

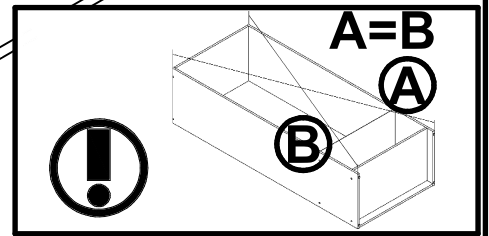
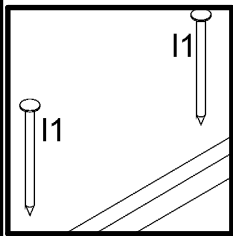
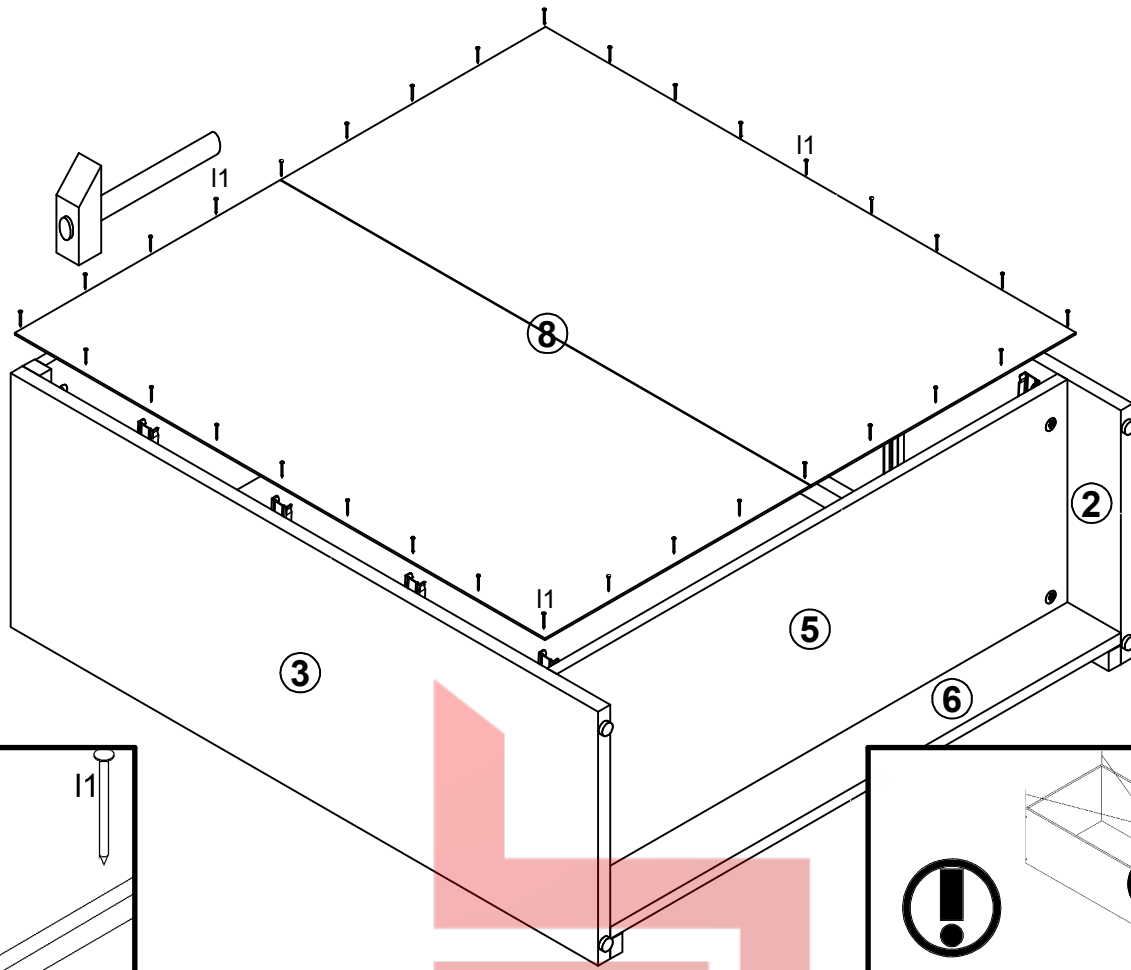

4

