

SETI

S135-REG/57

A	B	C	D
1	S135-105	2000	330
2	S135-106	2000	330
3	S135-355	500	320
4	S135-356	499	320
5	S135-367	500	320
6	S135-403	500	80
7	S135-905	1914	537

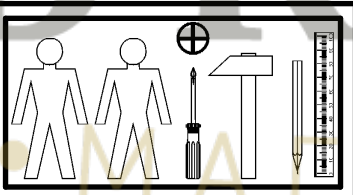
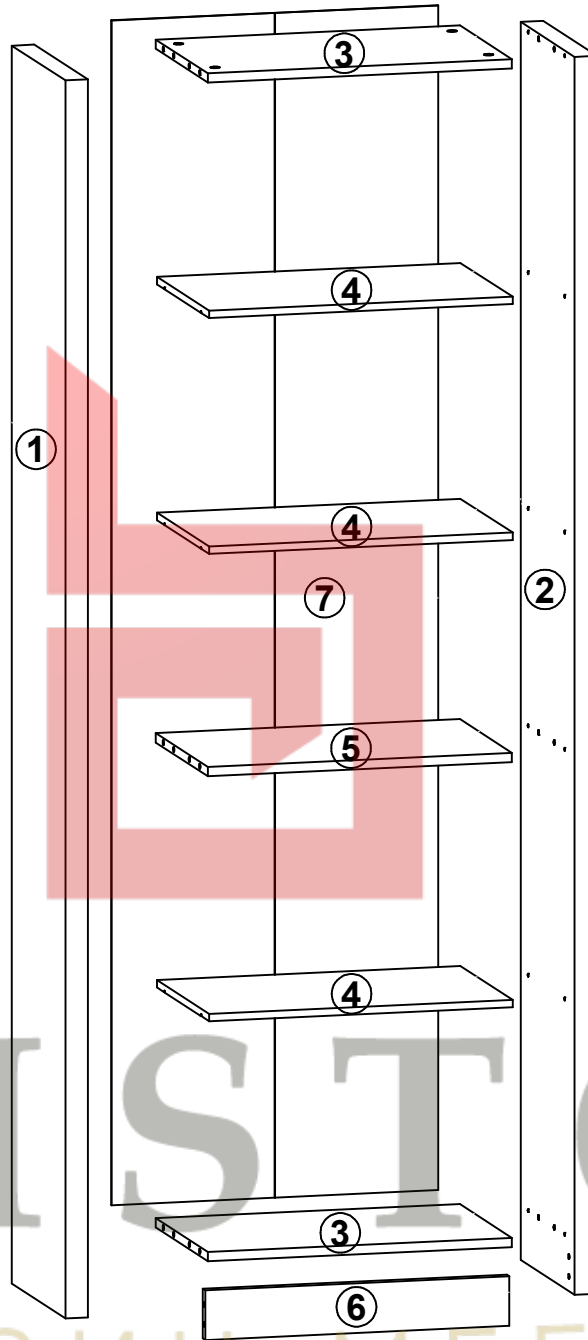
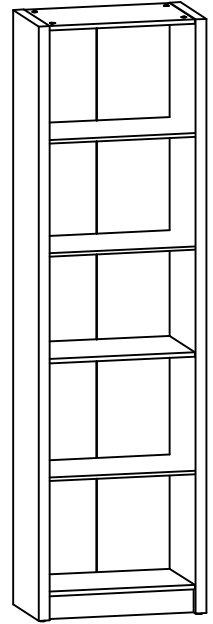

12x φ5x17 mm d1	16x φ8x30 mm f1	4x k1	55x l1	12x φ1.5x12mm #16 r1	12x r42	4x φ16 s2	1x n26\1	1x φ3.5x16 mm p38
-----------------------	-----------------------	----------	-----------	----------------------------	------------	-----------------	-------------	-------------------------

1 

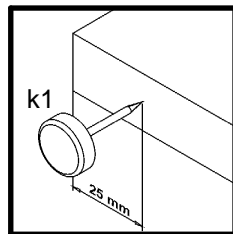
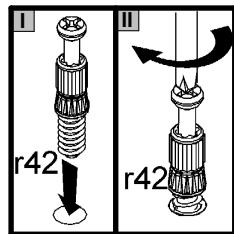
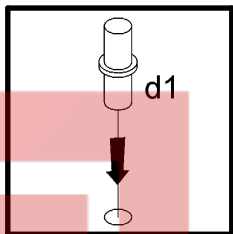
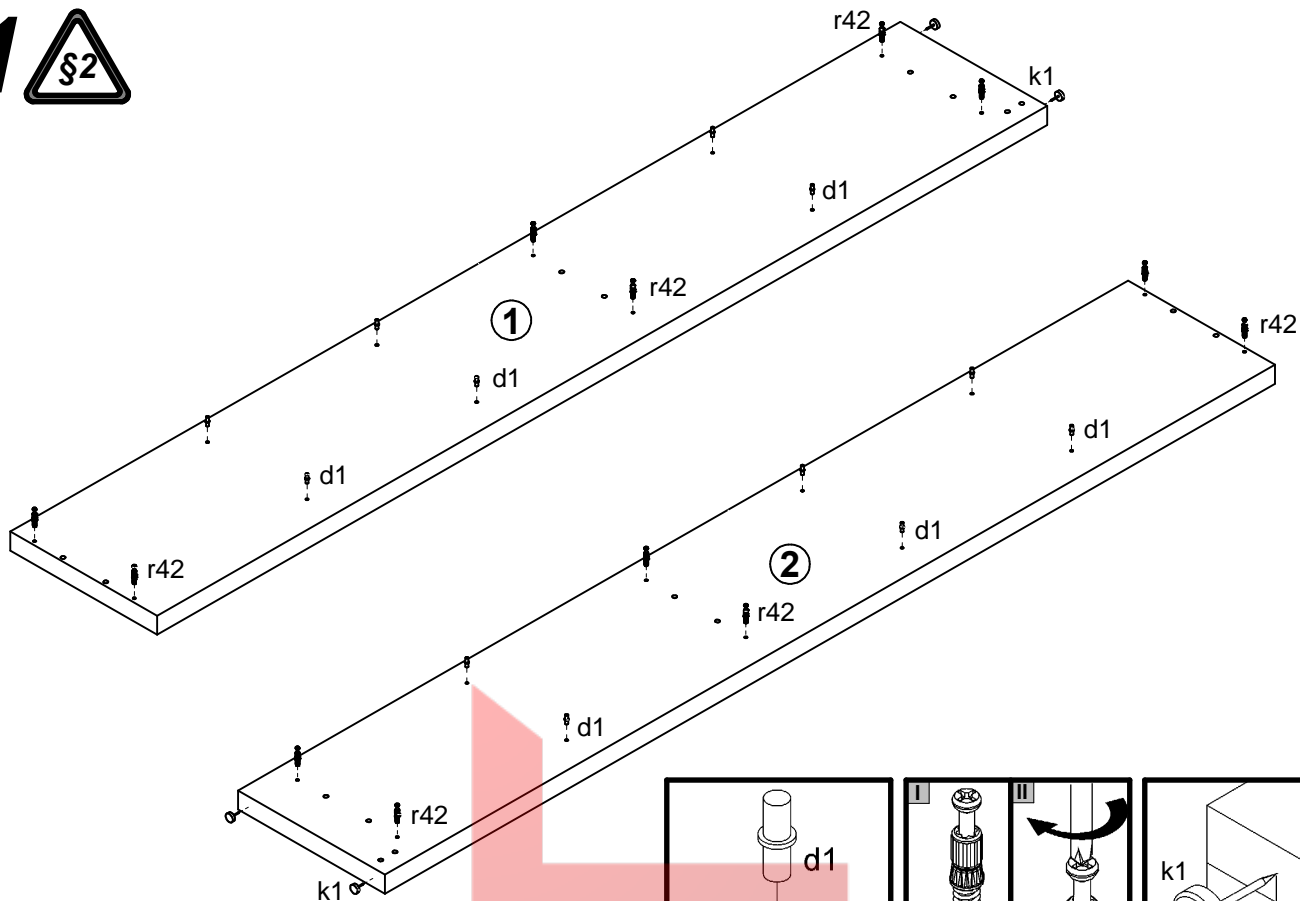

2 

