

| A | B | C | D | |
|----|---------|------|-----|-----|
| 1 | VT1-101 | 2123 | 567 | 1/3 |
| 2 | VT1-102 | 2123 | 567 | 1/3 |
| 3 | VT1-103 | 2027 | 567 | 1/3 |
| 4 | VT1-501 | 2123 | 54 | 1/3 |
| 5 | VT1-902 | 2074 | 581 | 1/3 |
| 6 | VT1-901 | 2074 | 595 | 1/3 |
| 7 | LH-2044 | 2044 | 14 | 1/3 |
| 8 | VT1-206 | 1800 | 607 | 2/3 |
| 9 | VT1-301 | 1726 | 567 | 2/3 |
| 10 | VT1-302 | 1138 | 567 | 2/3 |

| A | B | C | D | |
|----|---------|------|-----|-----|
| 11 | VT1-303 | 572 | 567 | 2/3 |
| 12 | VT1-304 | 572 | 567 | 2/3 |
| 13 | VT1-401 | 1726 | 80 | 2/3 |
| 14 | VT1-402 | 1726 | 80 | 2/3 |
| 15 | DR-1133 | 1133 | 22 | 2/3 |
| 16 | VT1-015 | 2040 | 560 | 3/3 |
| 17 | VT1-016 | 2040 | 560 | 3/3 |
| 18 | VT1-014 | 2040 | 560 | 3/3 |

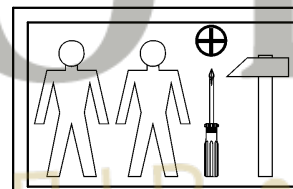
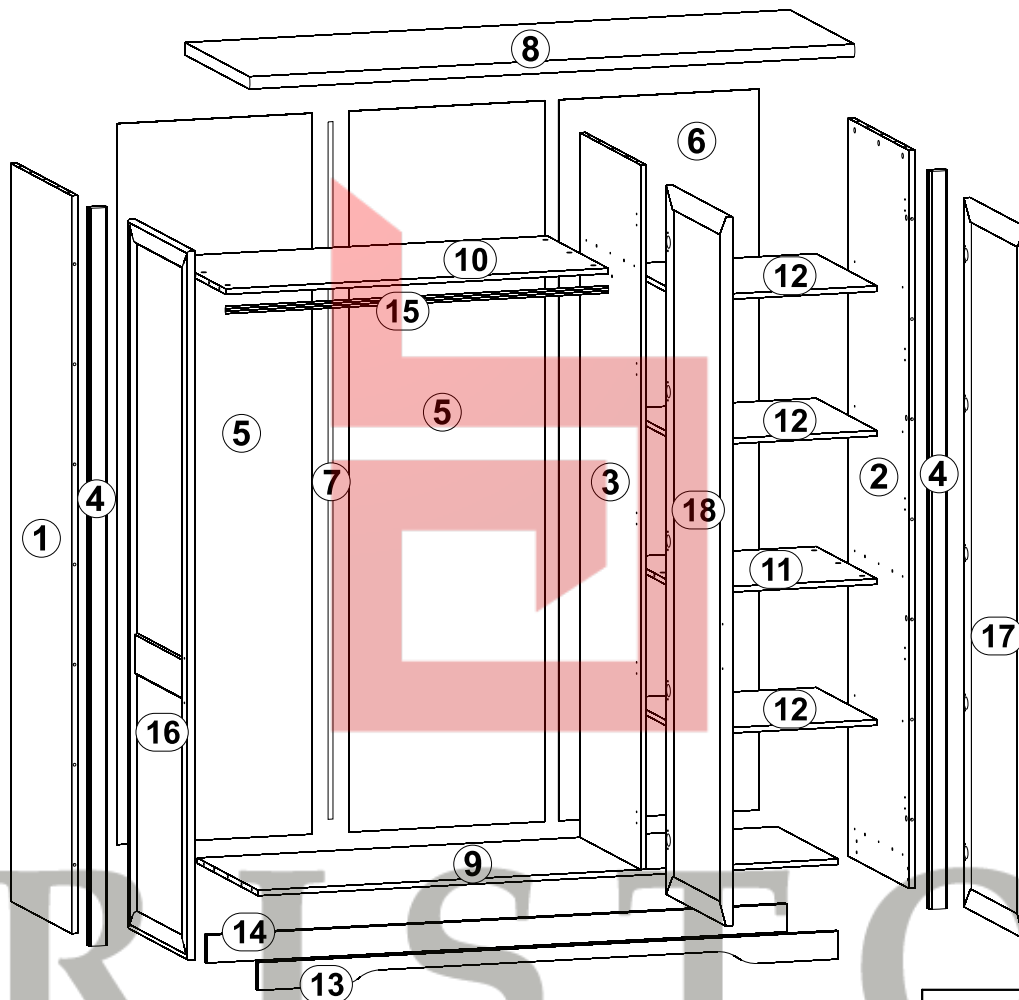
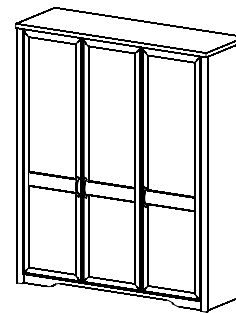

| | | | | | | |
|---------------------------|--------------------------|-----------------------|------------------------|----------------|------------------------|-----------------------|
| 10x a43 | 5x a40 | 10x b18 | 5x b22 | 3x c400 | 12x Ø5x17 mm d1 | 3x Ø7x50 mm e1 |
| 30x Ø 6,3x13 mm e5 | 20x Ø6,3x16 mm e7 | 39x Ø8x30mm f1 | 6x M4x28 mm j11 | 5x k1 | 135x l1 | 2x n1 |
| 2x Ø3,5x13 mm p1 | 35x Ø15 #16 r1 | 35x r16 | 30x s2 | 1x z1 | | |

1

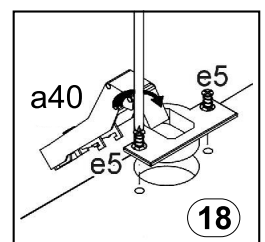
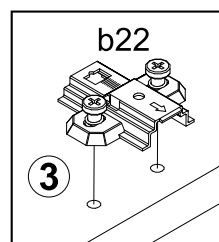
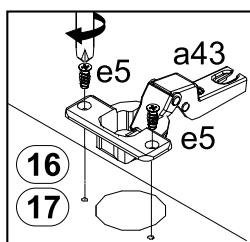
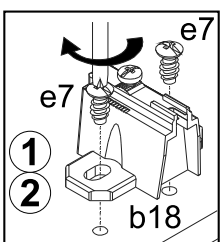
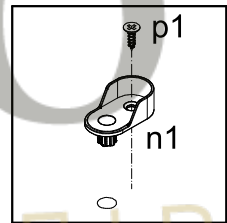
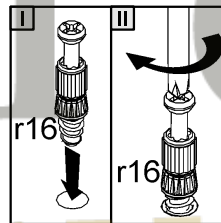
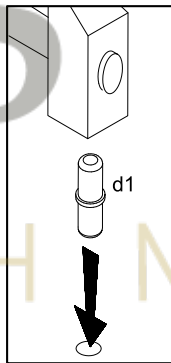
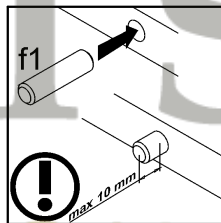
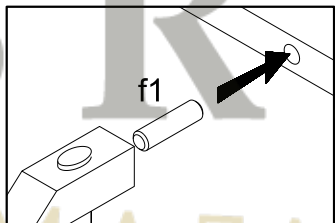
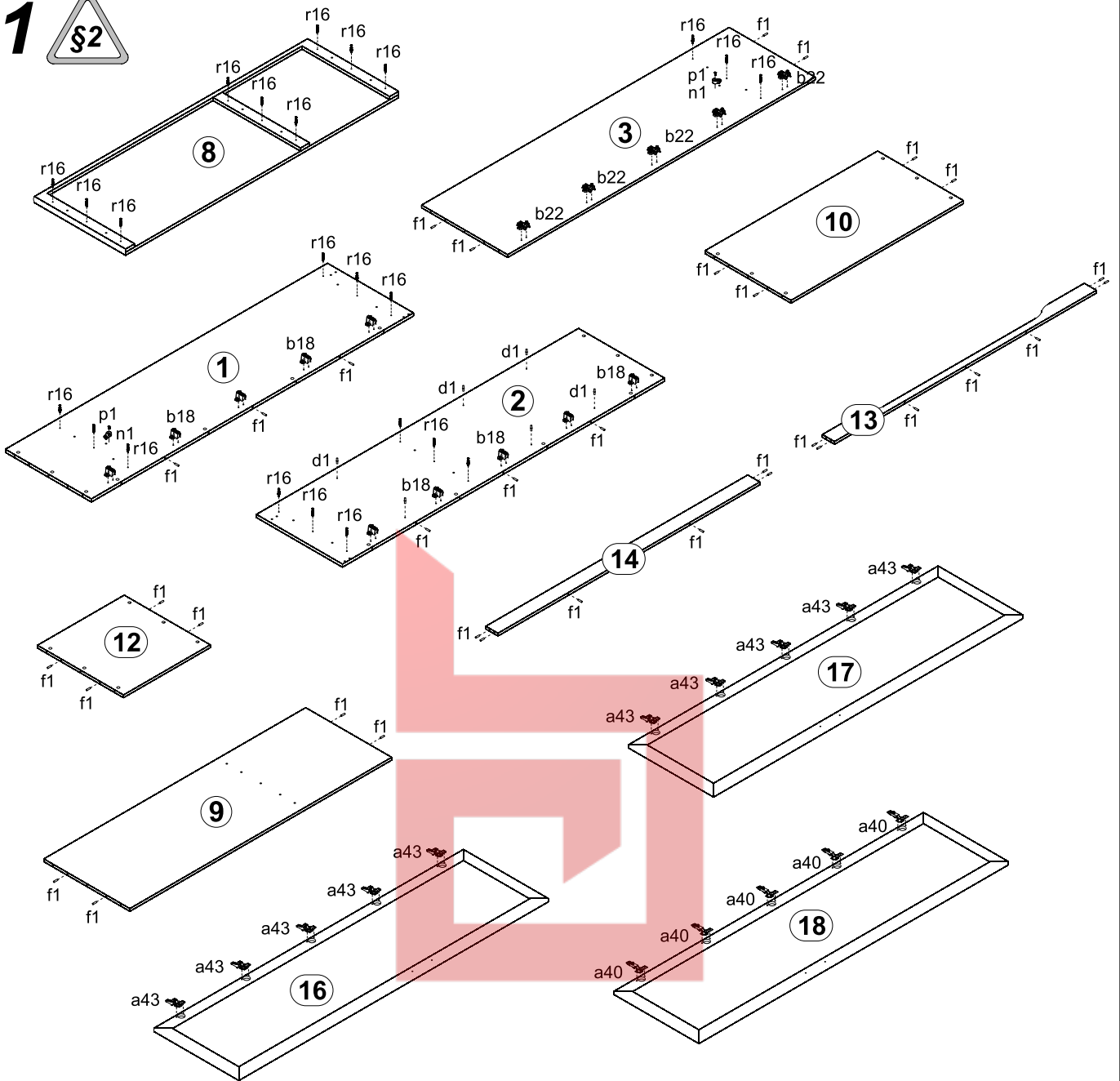

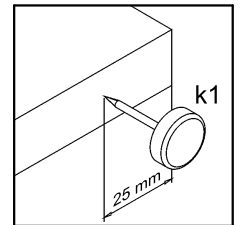
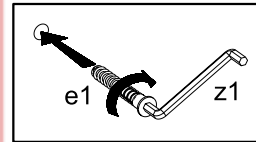
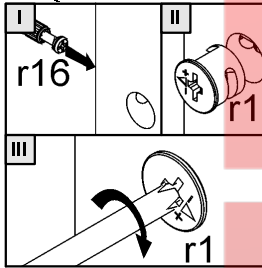
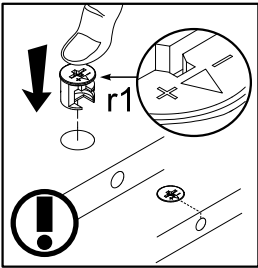
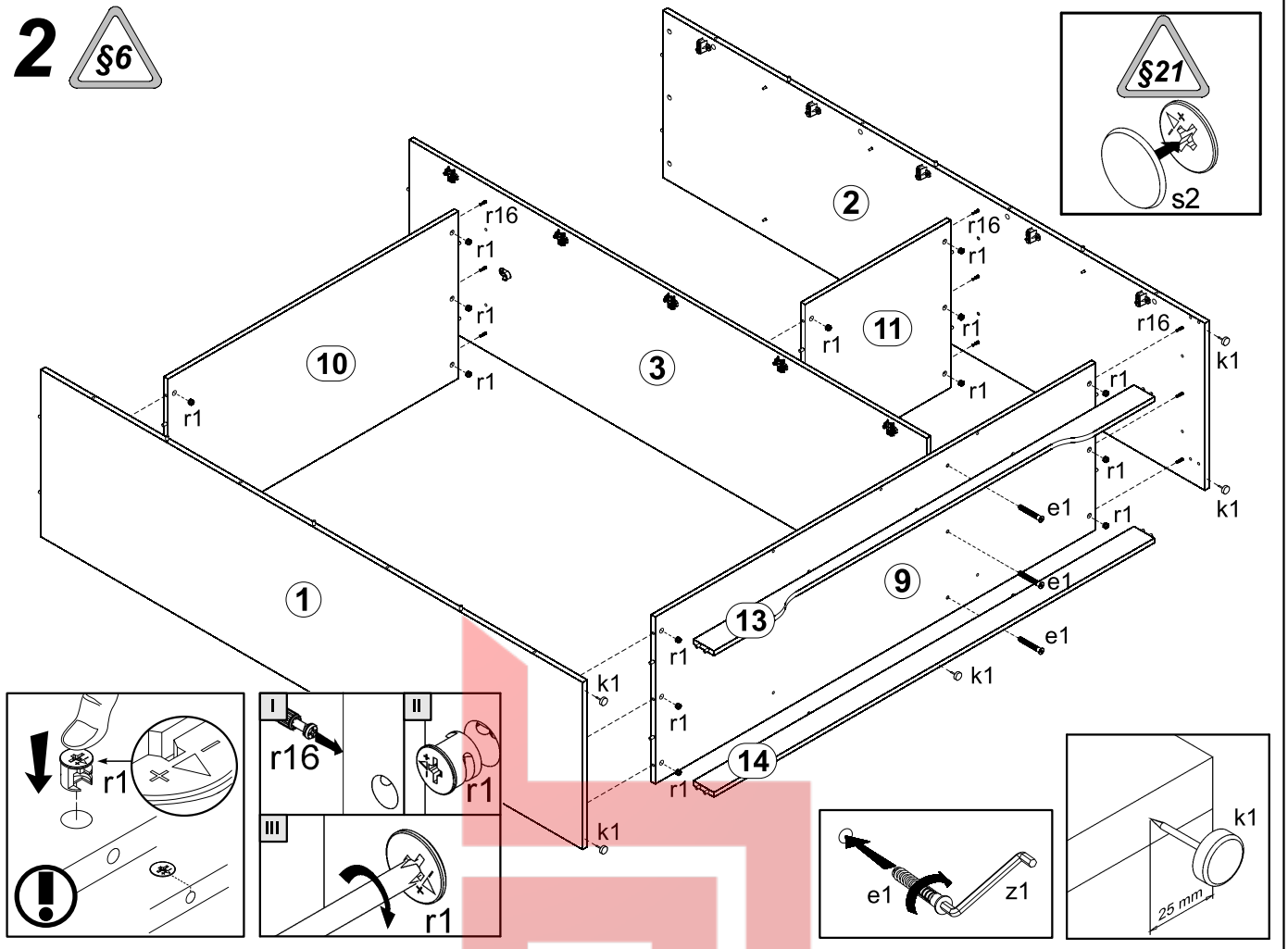
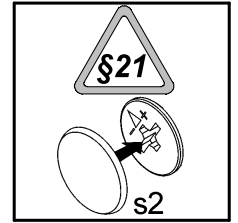
2**3**