

# INDI

szafa

A	B	C	D
1	S52-001	1541	392
2	S52-002A	796	167
3	S52-008	1541	392
4	S52-101	1988	540
5	S52-102	1988	540
6	S52-201	800	565
7	S52-301	767	540
8	S52-401	798	56
9	S52-402	767	80
10	S52-501	500	120
11	S52-502	500	120
12	S52-505	718	120
13	S52-551	1538	29
14	S52-904	728	498
15	S52-9901	1944	793
16	dr-761	761	22

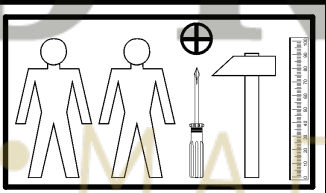
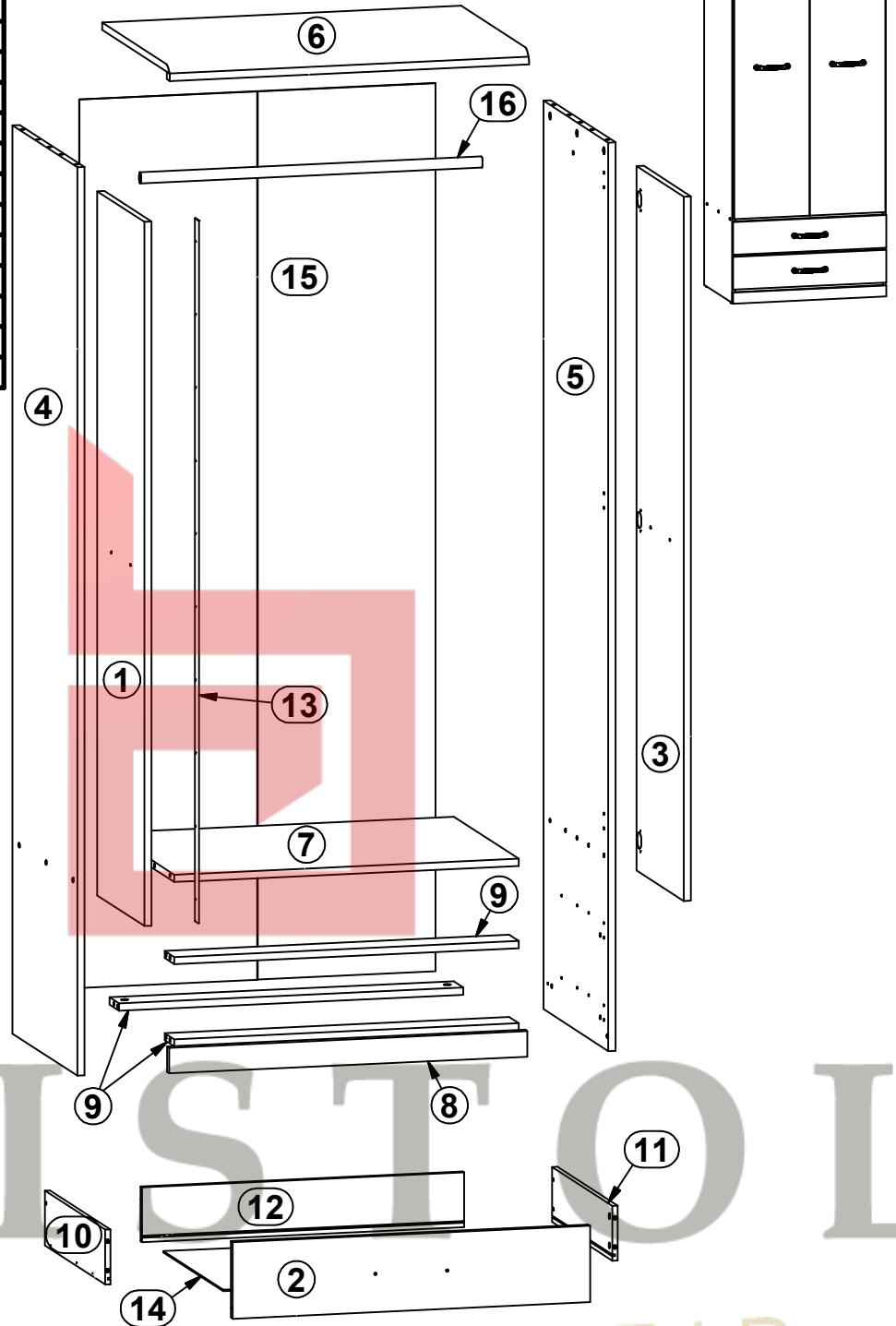

6x  a44	6x  b19	4x  c128	6x  e1	12x  e2	16x  e3	16x  f1	8x  f25	4x  k1
80x  l1	2x  l37	2x  n1	2x  p1	8x  p9	4x  p25	10x  p38	12x  p51	12x  p54
12x  r1	8x  r15	20x  r16	6x  s1	6x  s2	2x  t17	2x  w26\CL	2x  w26\CR	2x  w26\DL
2x  w26\DR	1x  z1	1x  n26\1	1x  p38					

1 

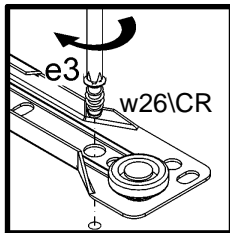
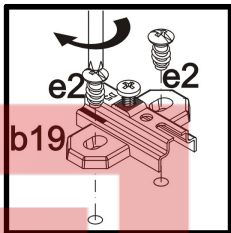
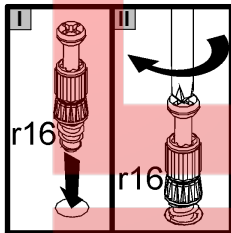
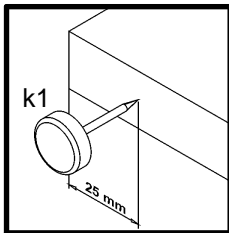
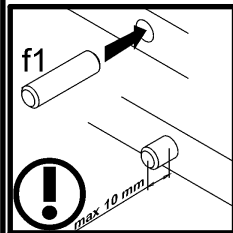
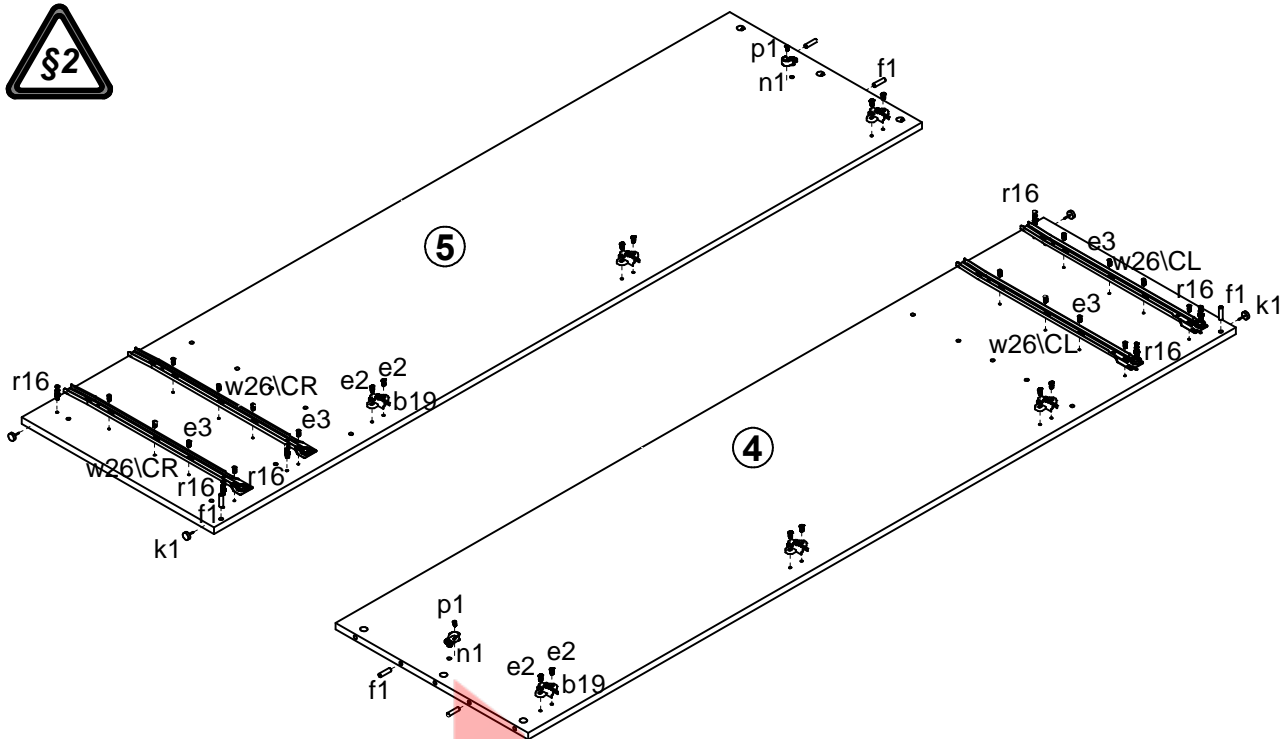

2 

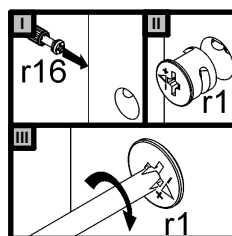
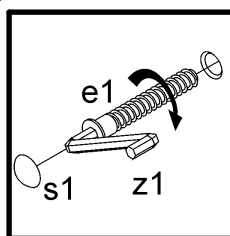
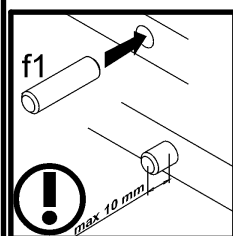
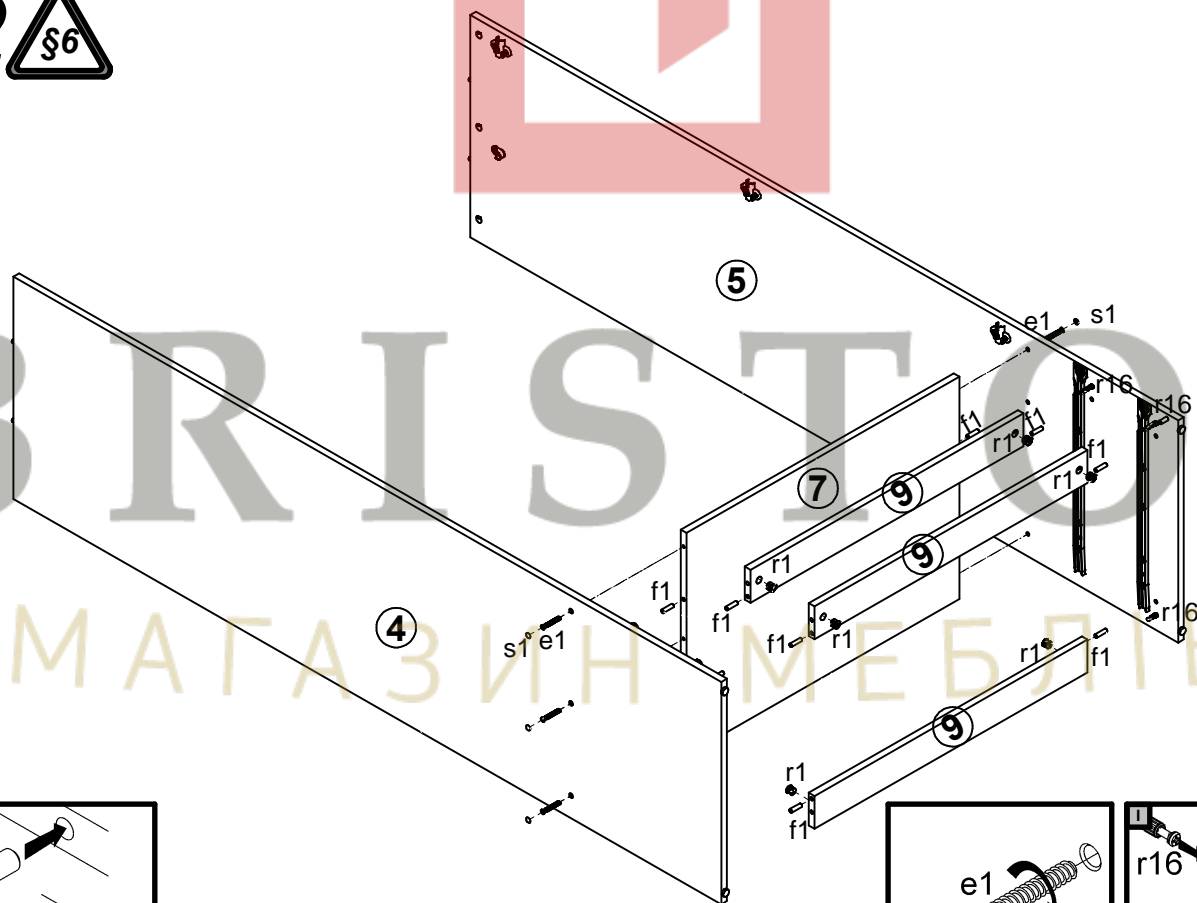

# 3

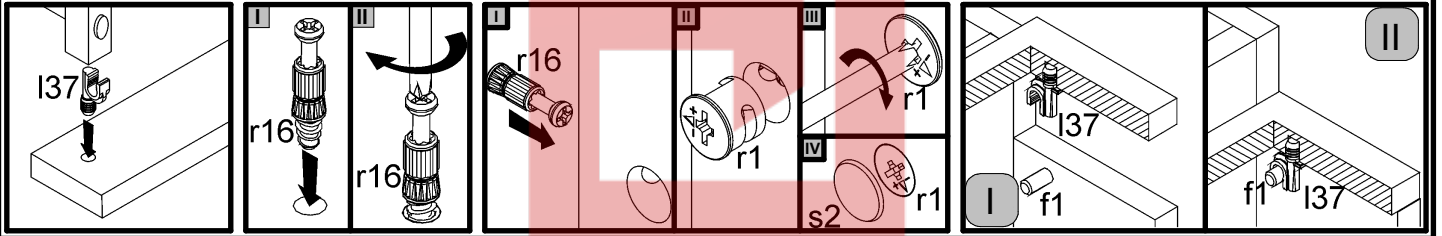
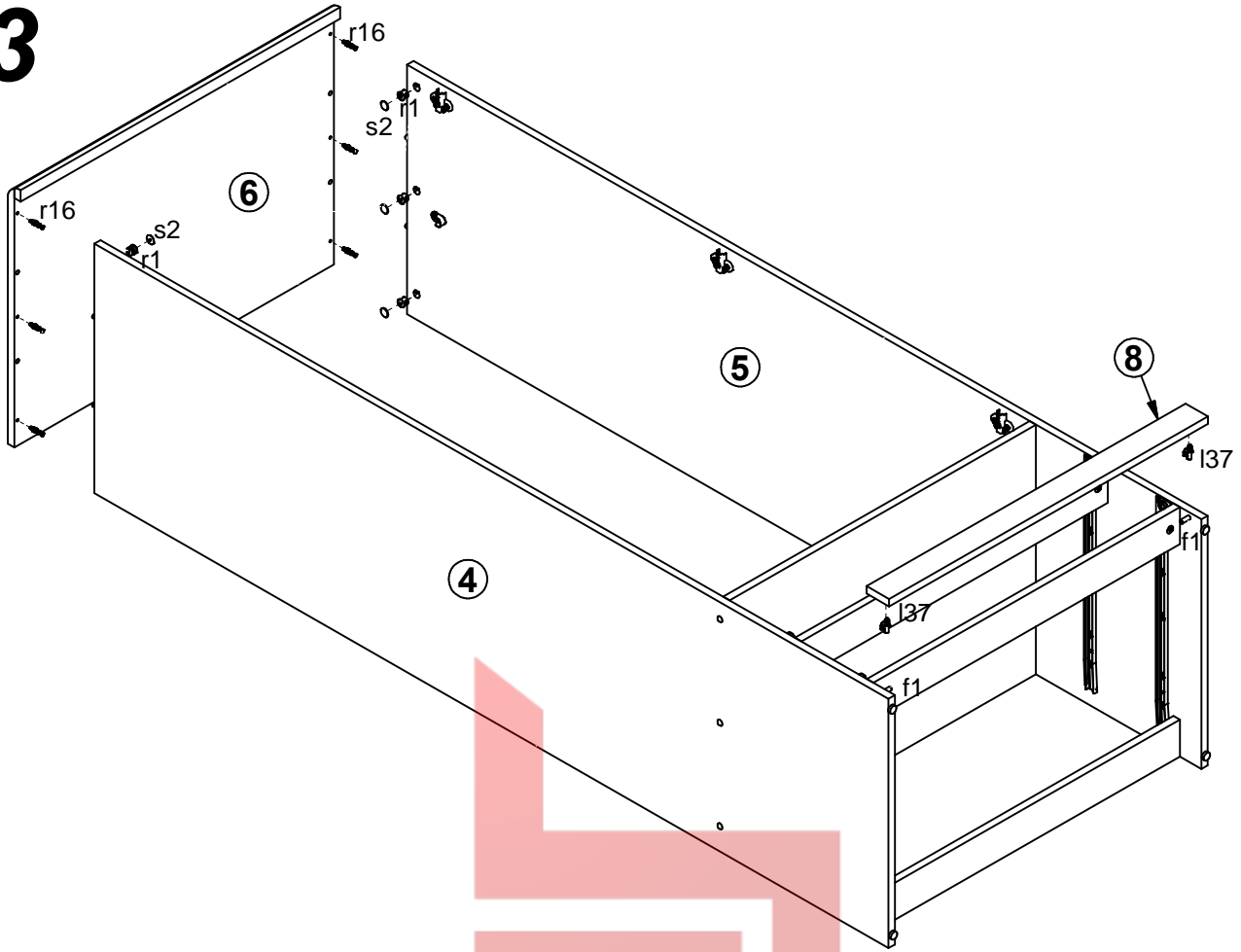

# 4

