

INDI

S52-KOM2D2S/8/8

A	B	C	D	A	B	C	D		
1	S52-005A	392	166	2/2	9	S52-401	798	56	1/2
2	S52-010	392	528	2/2	10	S52-410	375,5	80	1/2
3	S52-113	795	370	1/2	11	S52-411	767	54	1/2
4	S52-114	795	370	1/2	12	S52-503	350	120	1/2
5	S52-115	725	370	1/2	13	S52-504	350	120	1/2
6	S52-205	800	395	1/2	14	S52-507	326,5	120	1/2
7	S52-303	767	370	1/2	15	S52-906	337	348	1/2
8	S52-305	375,5	365	1/2	16	S52-9902	751	793	1/2

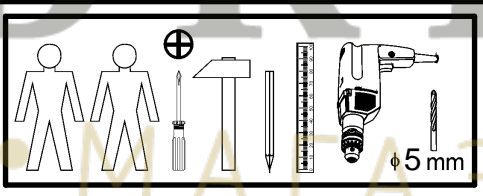
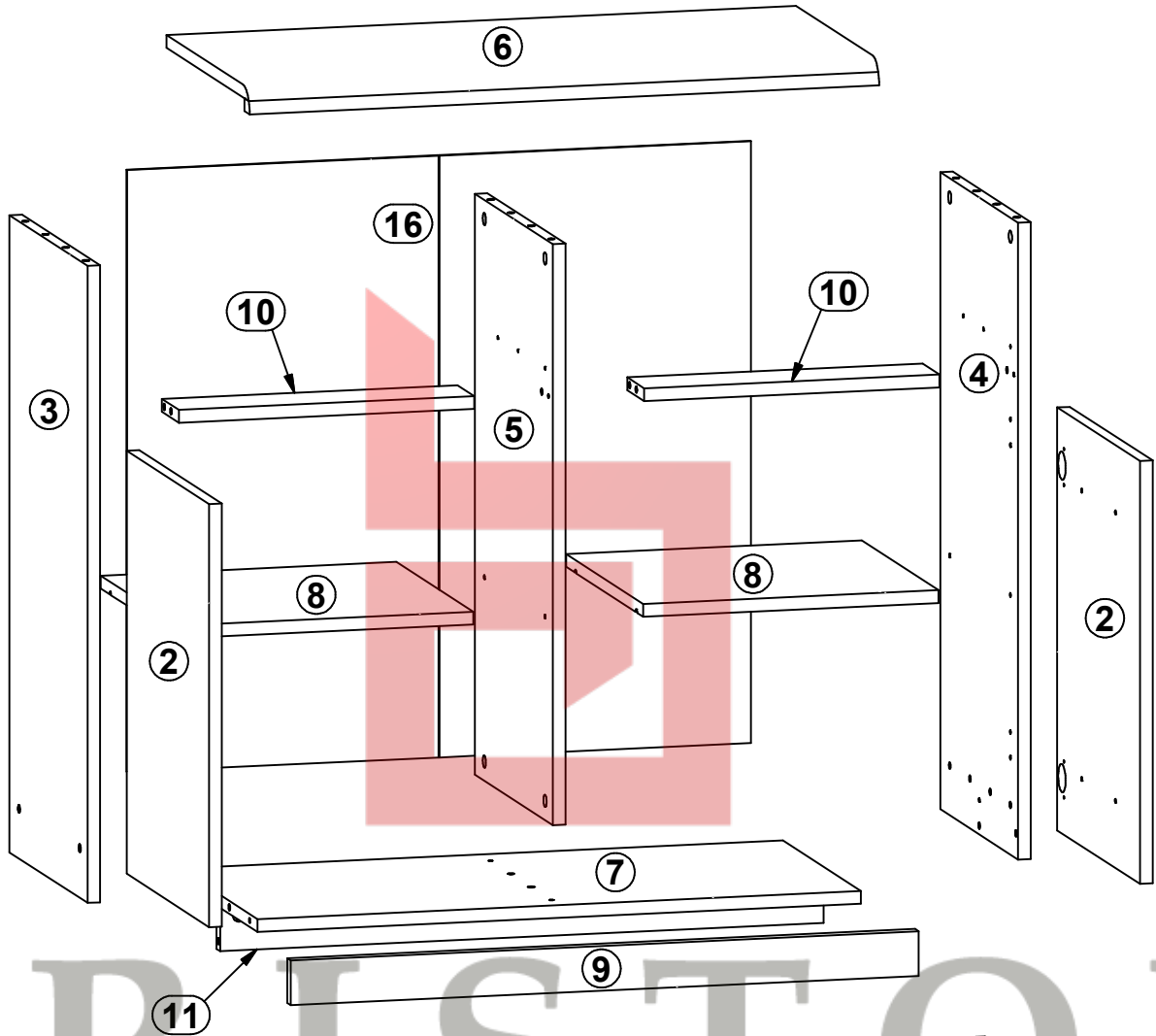
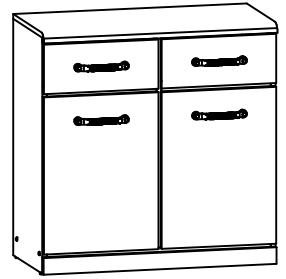

4x a44	4x b19	4x c128 160 mm	8x d1 φ5x17 mm	4x e1 φ7x50 mm	8x e2 φ6,3x13 mm	9x e3 φ6x13 mm	20x f1 φ8x30 mm	8x f25 φ6,5x40 mm
4x k1	46x l1	2x l37	3x p1 φ3,5x13 mm	8x p9 φ4x30 mm	8x p51 φ3,5x15 mm	8x p54 φ3x12 mm	14x r1 φ1,5x12mm #16	8x r15 φ12x10,5mm #12
22x r16	4x s1	9x s2 ø16	2x w45\CL 350 mm	2x w45\CR 350 mm	2x w45\DL 350 mm	2x w45\DR 350 mm	1x z1	1x n26\1
1x p38 φ3,5x16 mm								

1 

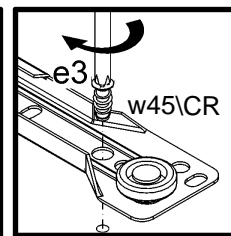
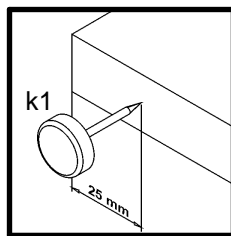
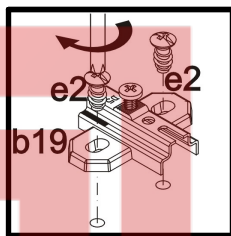
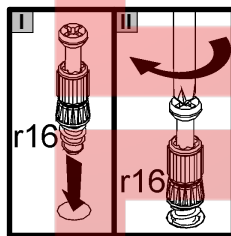
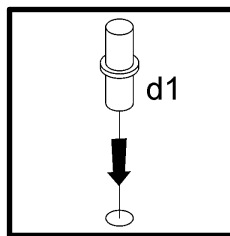
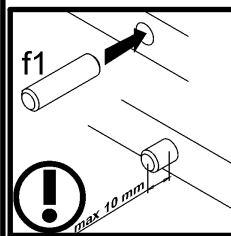
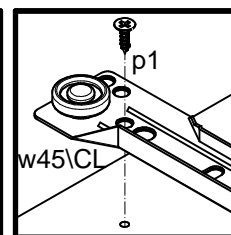
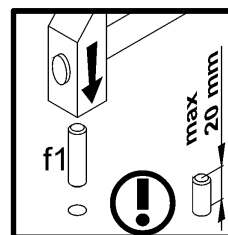
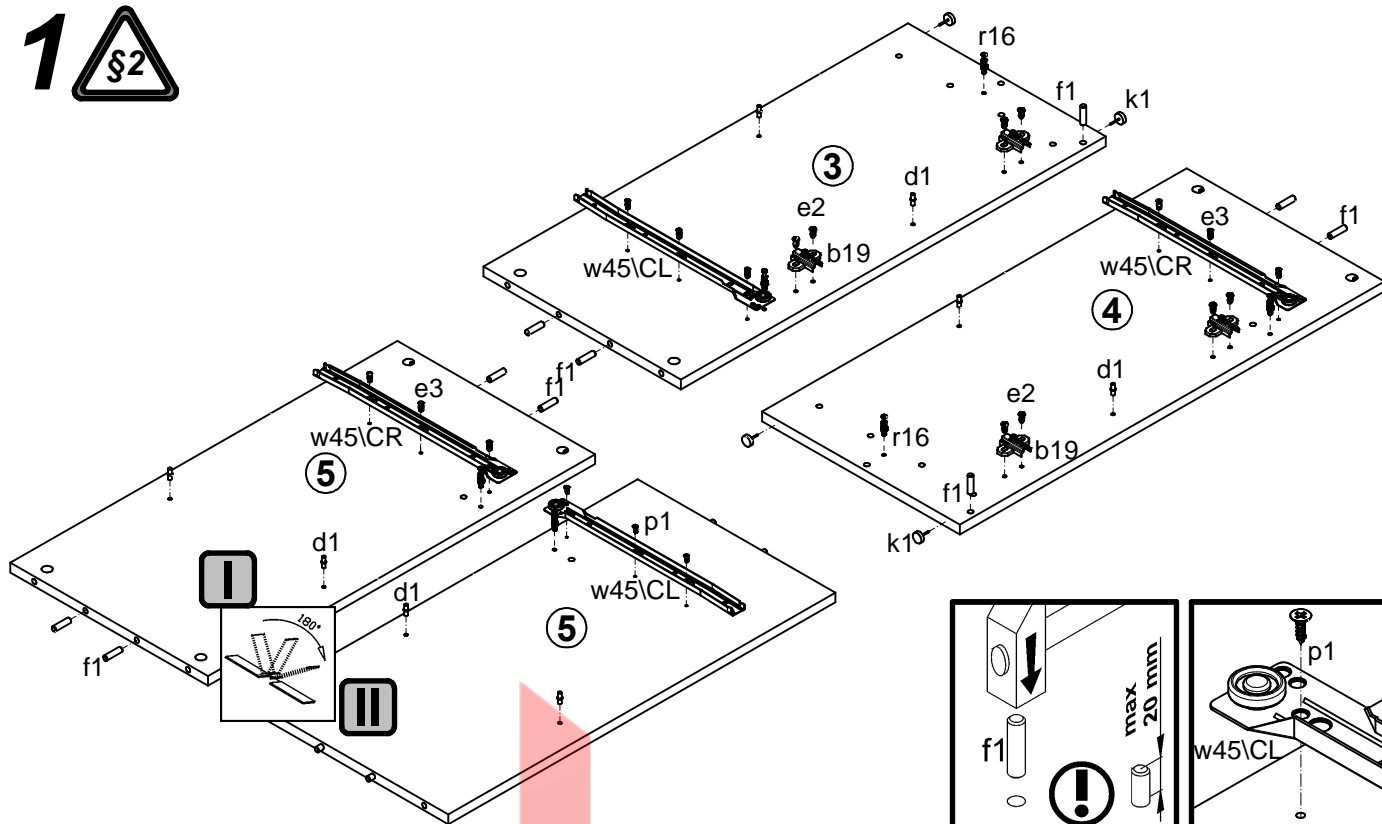

2 

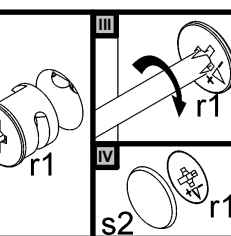
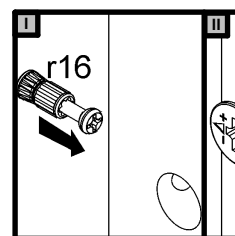
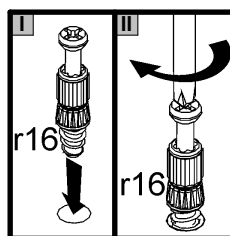
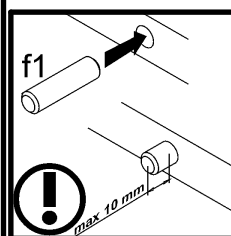
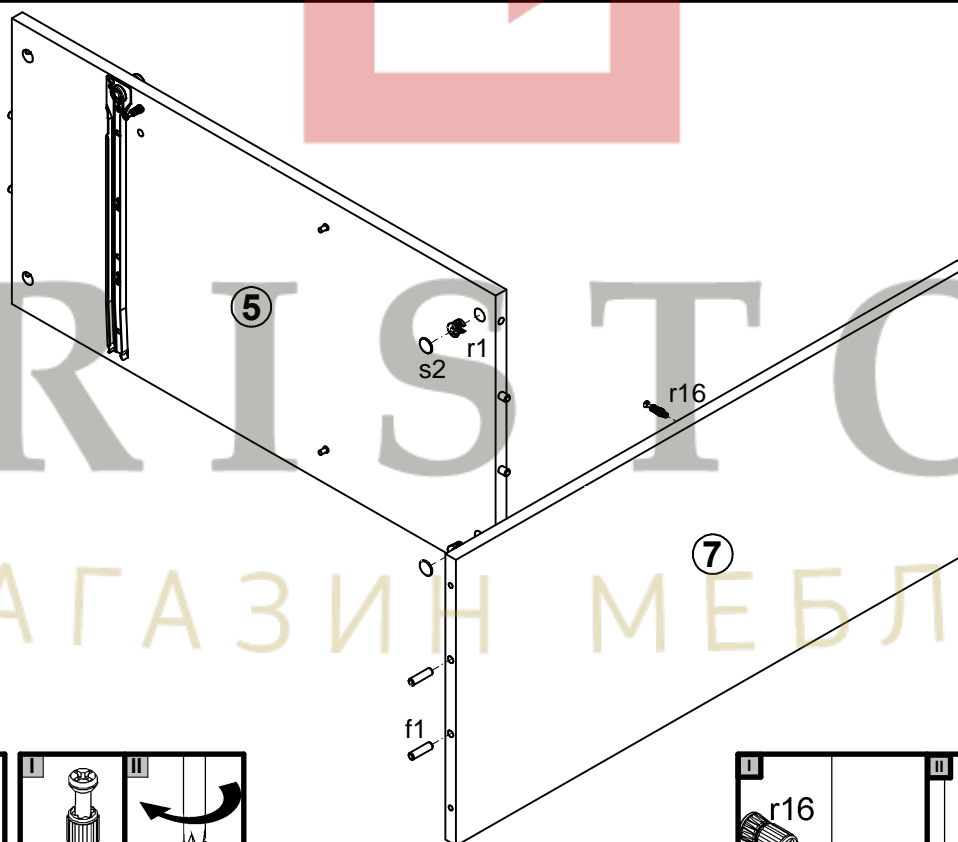

3

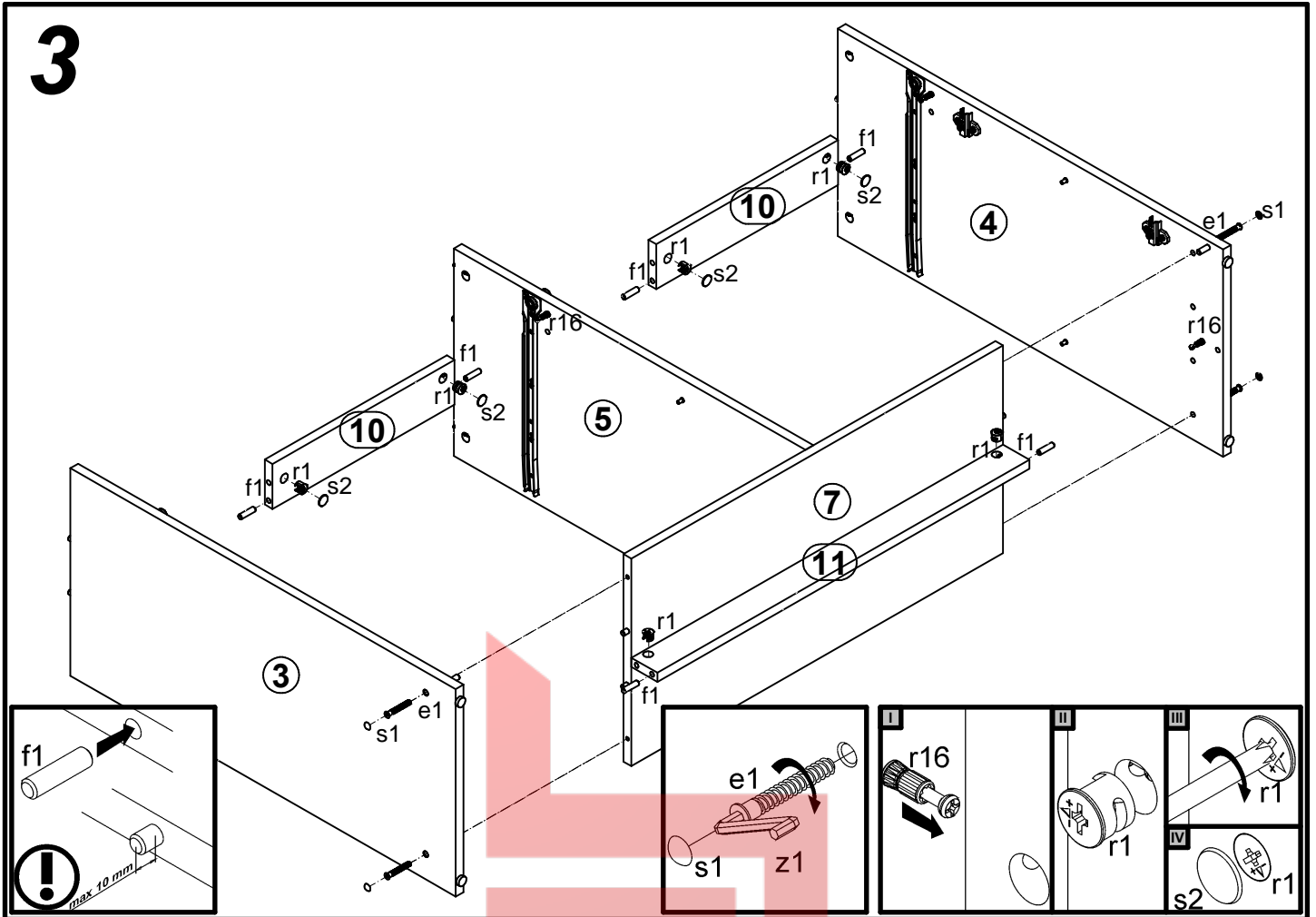

4

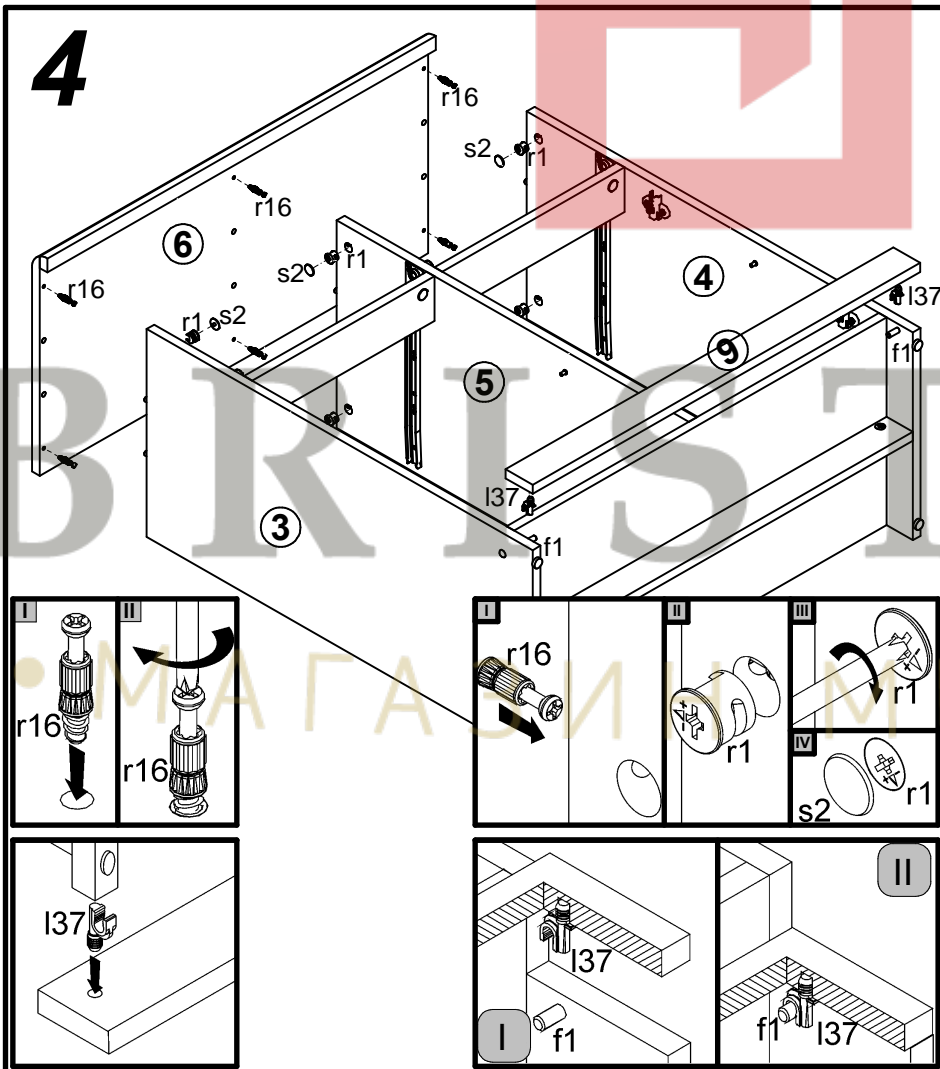

5

