

CAPS

S153-BIU/120

A	B	C	D	A	B	C	D		
1	S153-0008	365	188	1/3	10	S153-4403	738	360	1/3
2	S153-0010	455	365	1/3	11	S153-4404	652	385	1/3
3	S153-1114	728	579	1/3	12	S153-578	188	49	3/3
4	S153-1115	728	579	1/3	13	S153-579	337	49	3/3
5	S153-1116	728	579	1/3	14	S153-9908	332	498	2/3
6	S153-2205	1205	600	2/3	15	ZS2-509	500	120	2/3
7	S153-3311	385	563	2/3	16	ZS2-510	500	120	2/3
8	S153-3314	713	385	1/3	17	ZS2-5559	321	120	2/3
9	S153-3325	384	524	1/3					

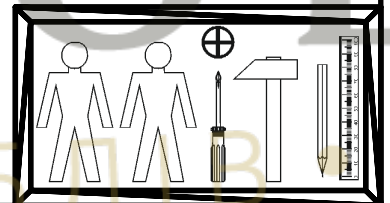
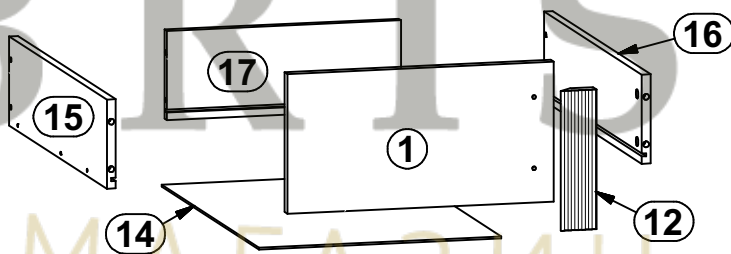
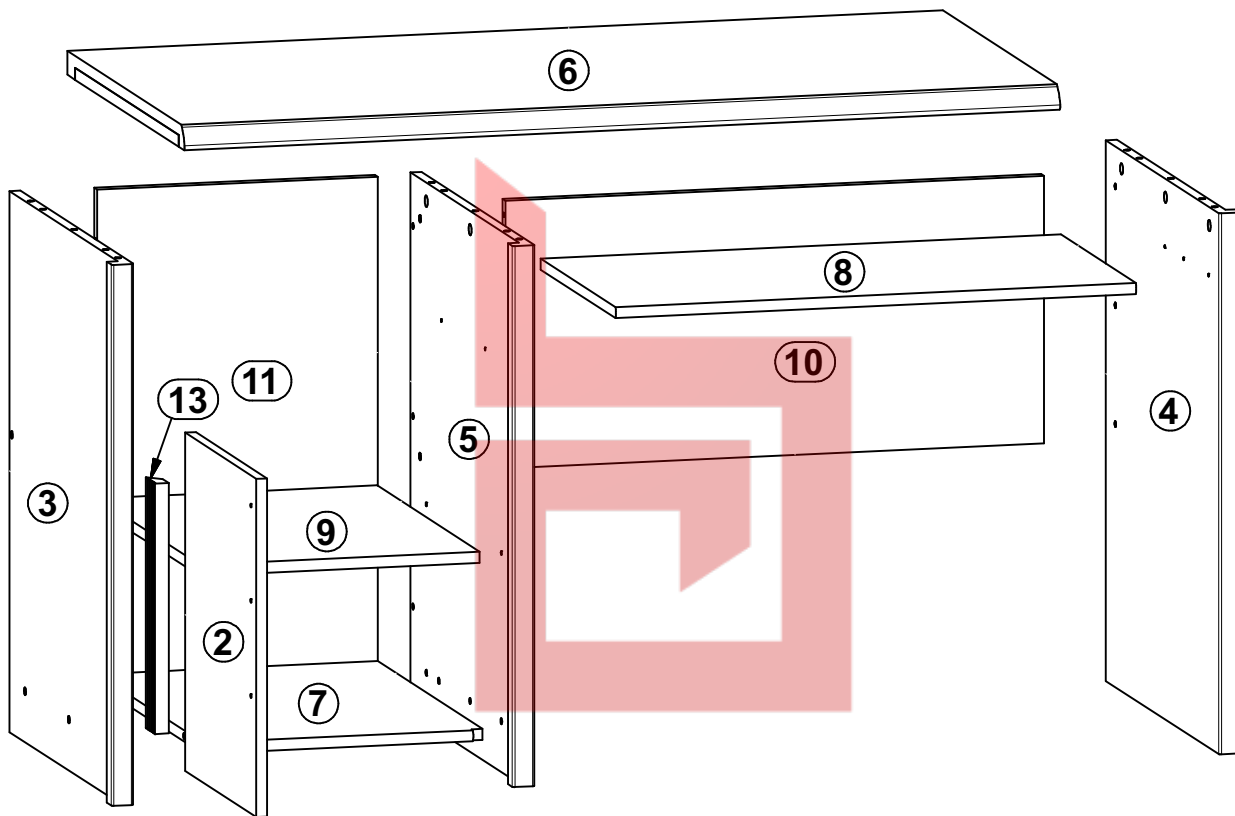
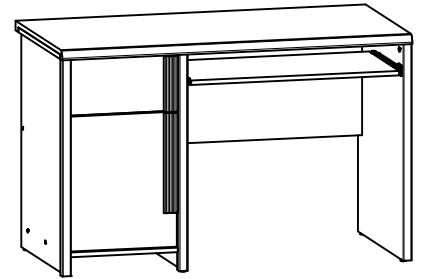

2x K16 a43	2x DS b19	4x φ5x17 mm d1	12x φ7x50 mm e1	6x φ5x9 mm e19	4x φ6,5x13 mm e2	3x φ6x28 mm e25	9x φ6x13 mm e3	16x φ8x30 mm f1
4x φ6,5x40 mm f25	6x k1	4x φ3,5x13 mm p27	4x φ3,5x15 mm p51	5x φ4x22 mm p60	9x φ1,5x12mm #16 r1	4x φ12x10,5mm #12 r15	13x r42	1x 500 mm w26\CL
1x 500 mm w26\CR	1x 500 mm w26\DL	1x 500 mm w26\DR	1x 350 mm w45\CL	1x 350 mm w45\CR	1x 350 mm w45\DL	1x 350 mm w45\DR	3x h=16 mm w47	11x s1
5x φ16 s2	1x z1							

1 

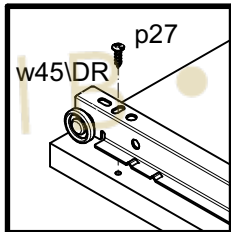
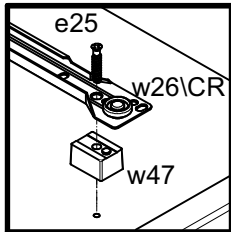
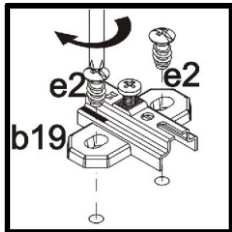
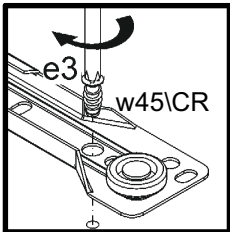
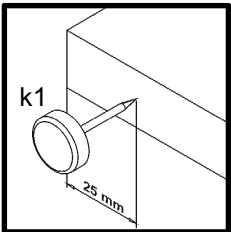
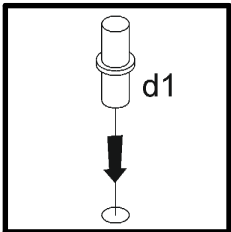
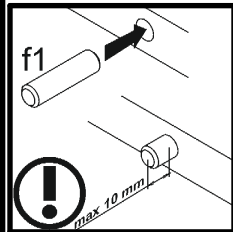
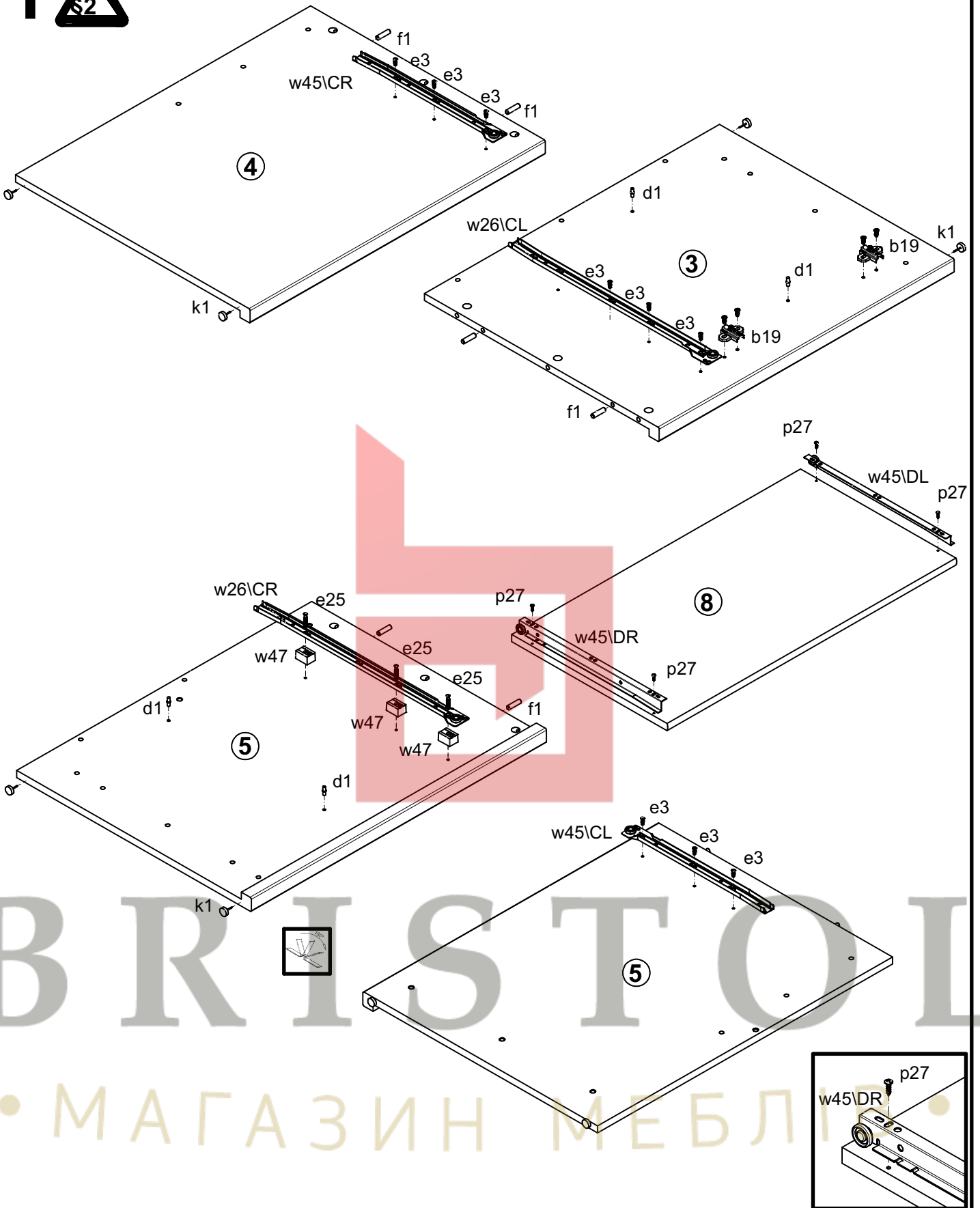

2 

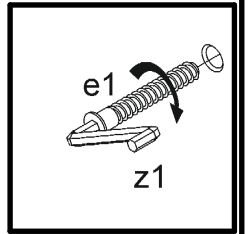
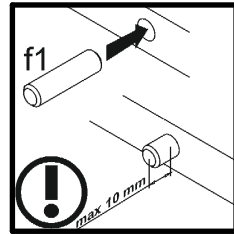
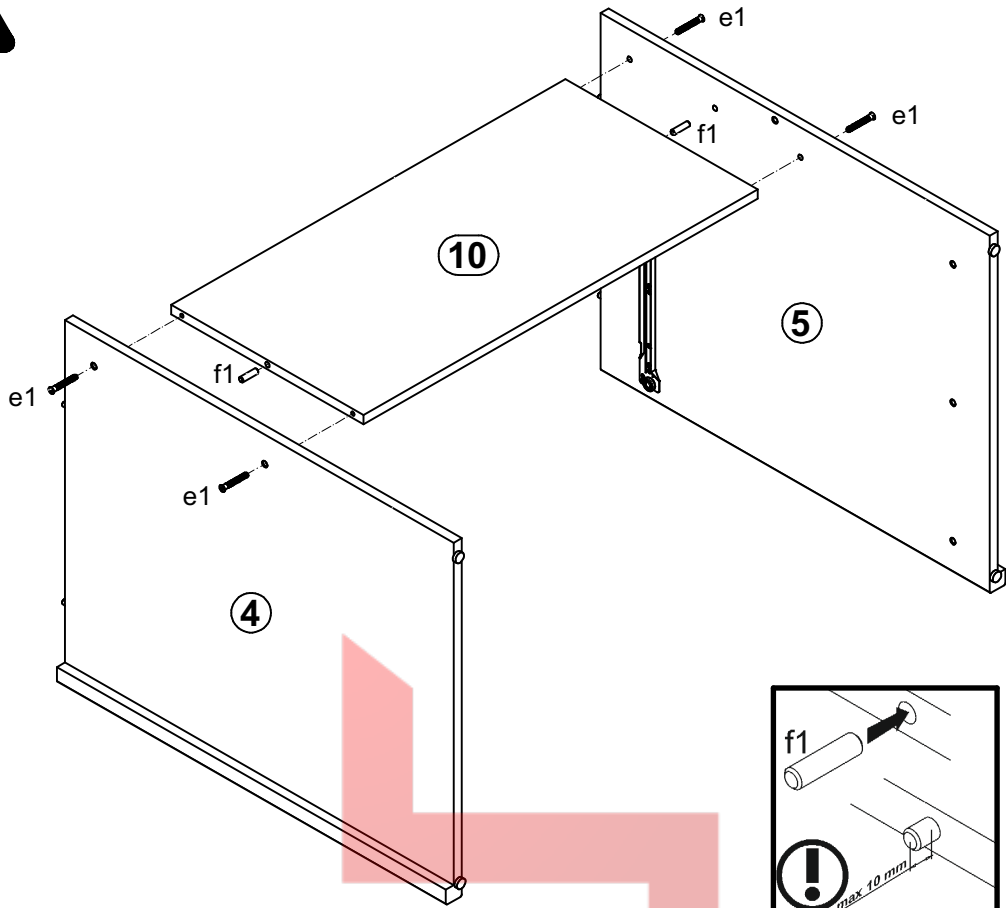

3

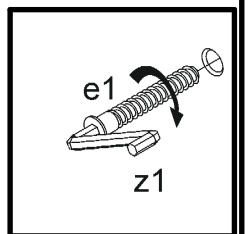
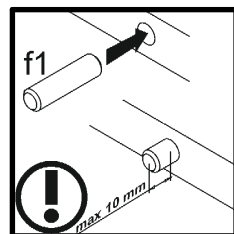
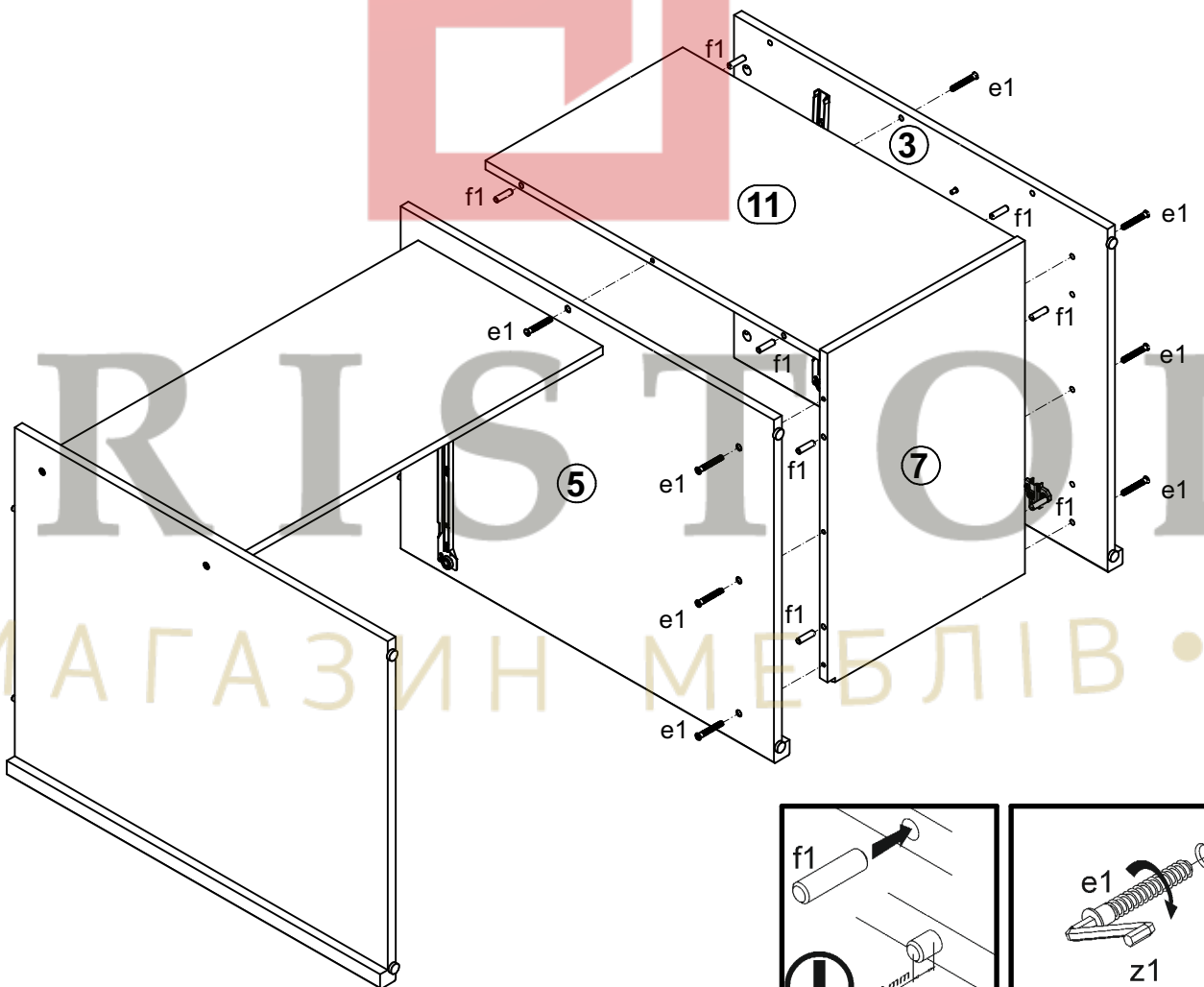

4

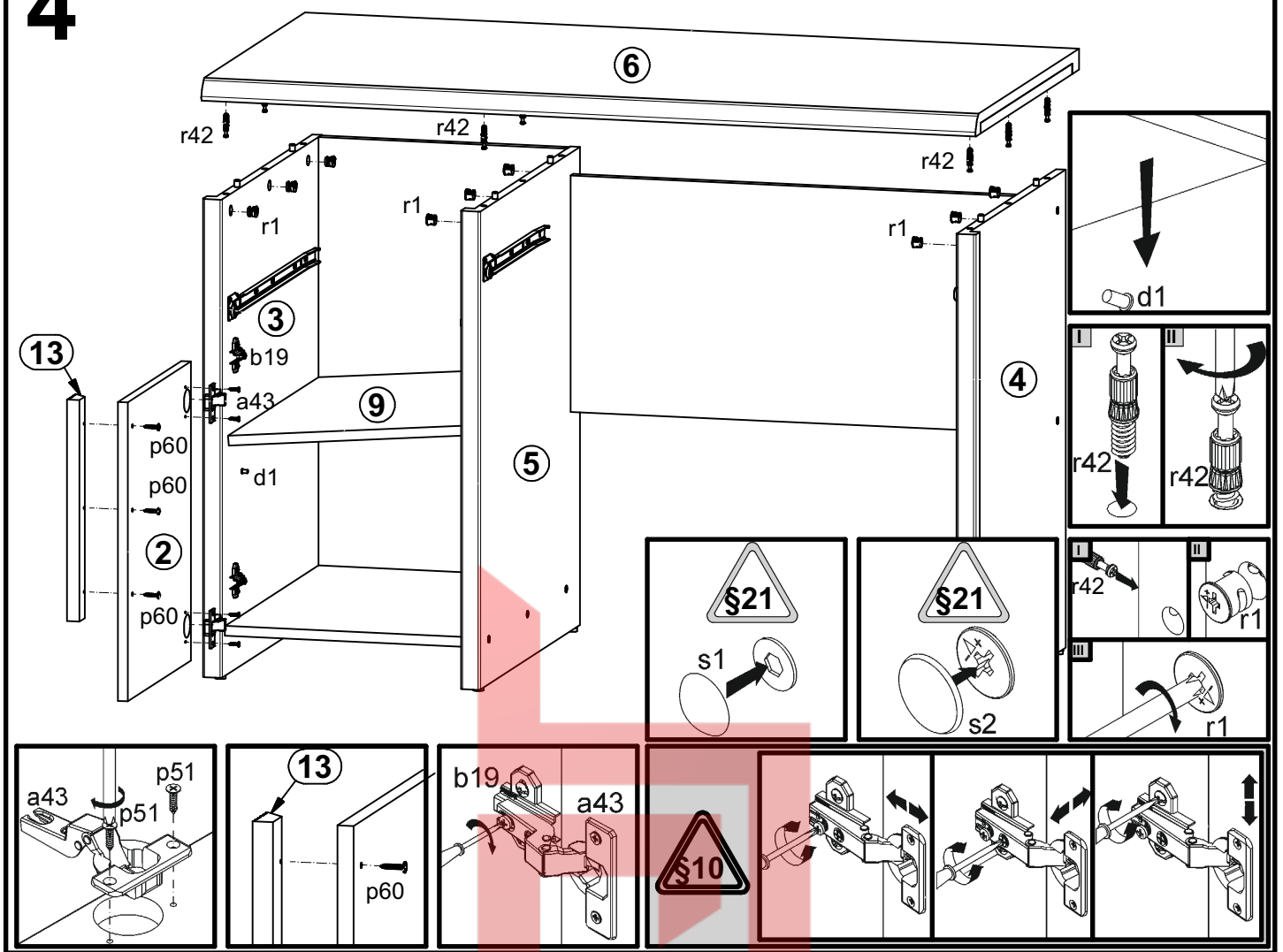

5

