

CAPS

S153-SZF2D2S

A	B	C		D
1	S153-0001	733	188	3/3
2	S153-0002	733	188	3/3
3	S153-0005	1484	365	3/3
4	S153-1107	1948	519	1/3
5	S153-1108	1948	519	1/3
6	S153-2203	804	523	1/3
7	S153-3306	738	503	1/3
8	S153-3307	738	484	1/3
9	S153-571	188	100	2/3
10	S153-572	70	100	2/3
11	S153-573	1484	49	2/3
12	S153-9907	700	448	1/3
13	S153-9915	1912	381	1/3
14	ZS2-515	450	120	1/3
15	ZS2-516	450	120	1/3
16	ZS2-5583	689	120	1/3
17	dr-733	733	22	1/3
18	dr-1882	1882	14	1/3

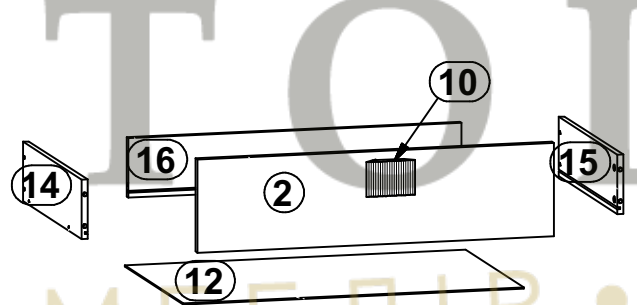
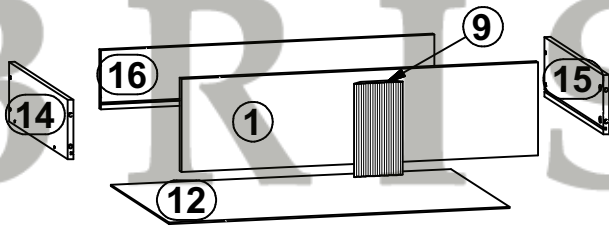
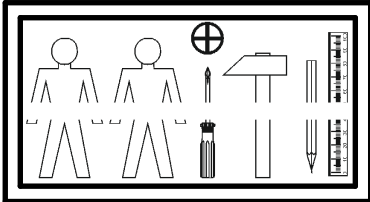
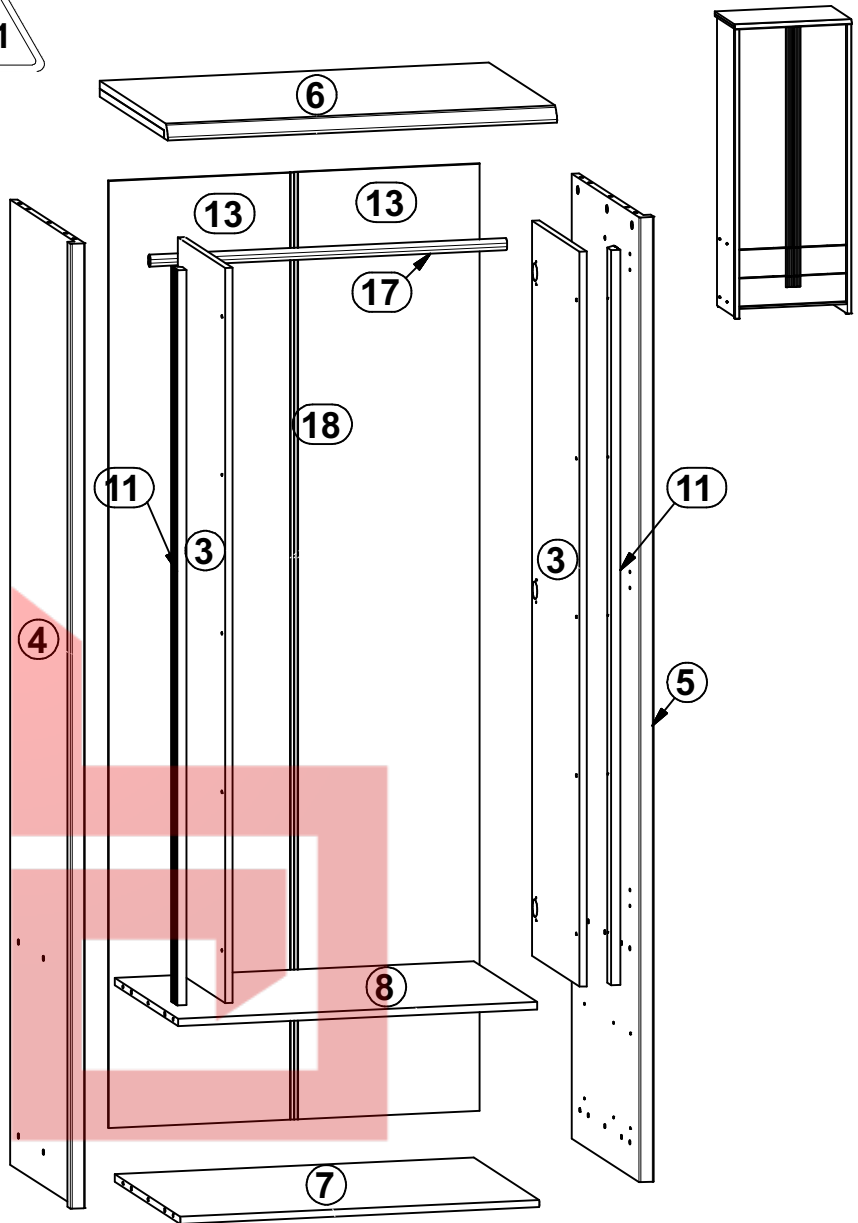

6x K16 a43	6x b19	12x e1 φ7x50 mm	8x e19 φ5x9 mm	12x e2 φ6,3x13 mm	12x e3 φ6x13 mm	12x f1 φ8x30 mm	8x f25 φ6,5x40 mm	4x k1
65x l1	2x n1	2x p1 φ3,5x13 mm	4x p25 φ3,5x16 mm	12x p51 φ3,5x15 mm	14x p60 φ4x22 mm	6x r1 φ1,5x12mm #16	8x r15 φ1,2x10,5mm #12	14x r42
2x t37 433 mm	2x w24\ICL 450 mm	2x w24\CR 450 mm	2x w24\DL 450 mm	2x w24\DR 450 mm	1x z1	1x n26\1	1x p38 φ3,5x16 mm	12x s1
6x s2 φ16								

1 

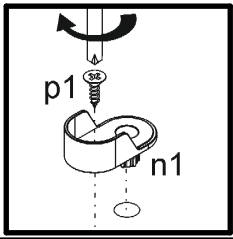
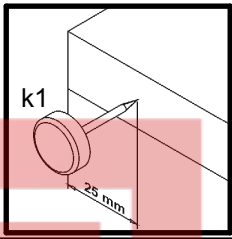
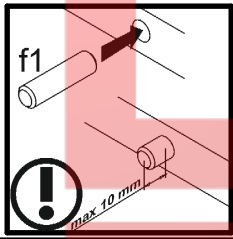
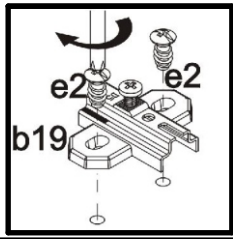
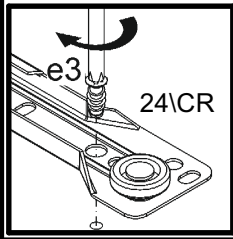
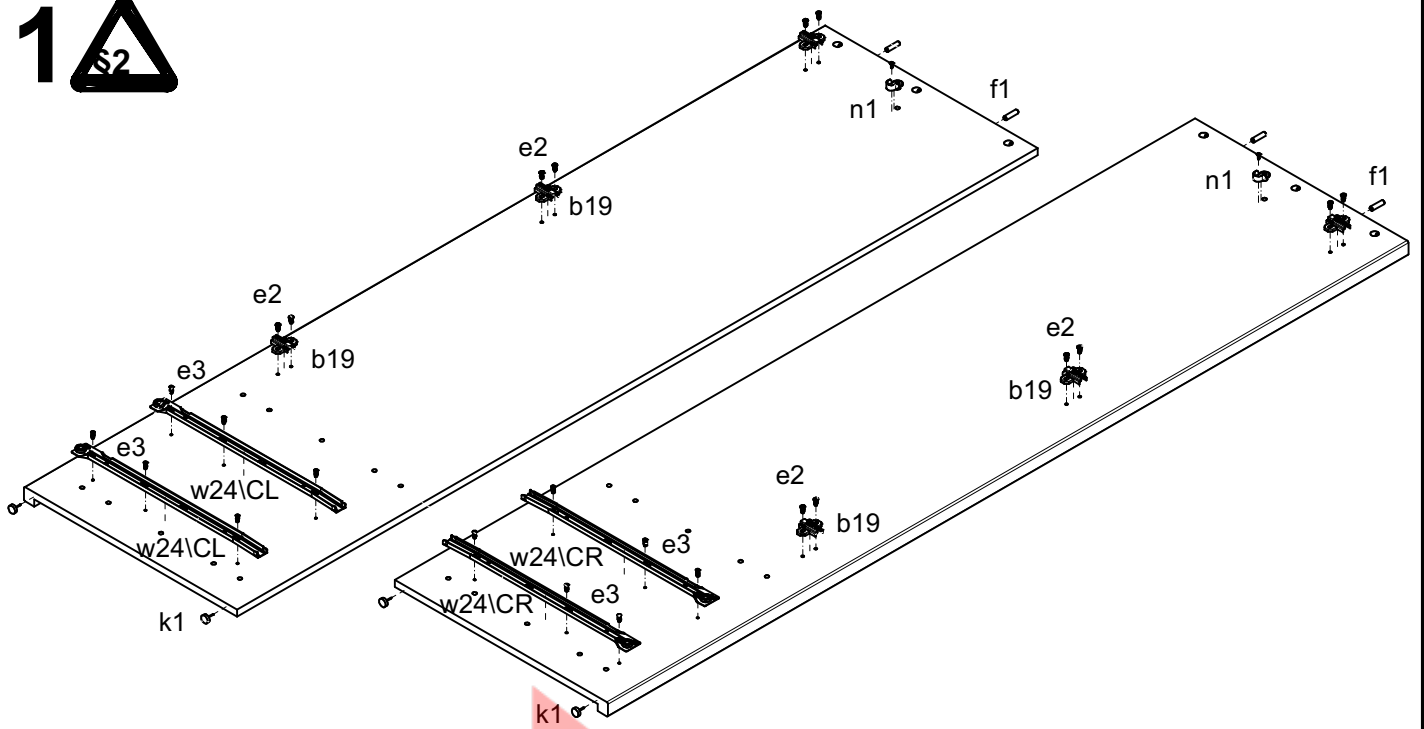

2 

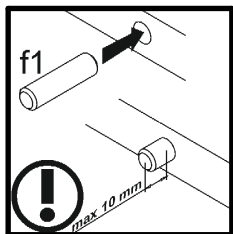
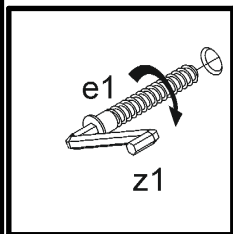
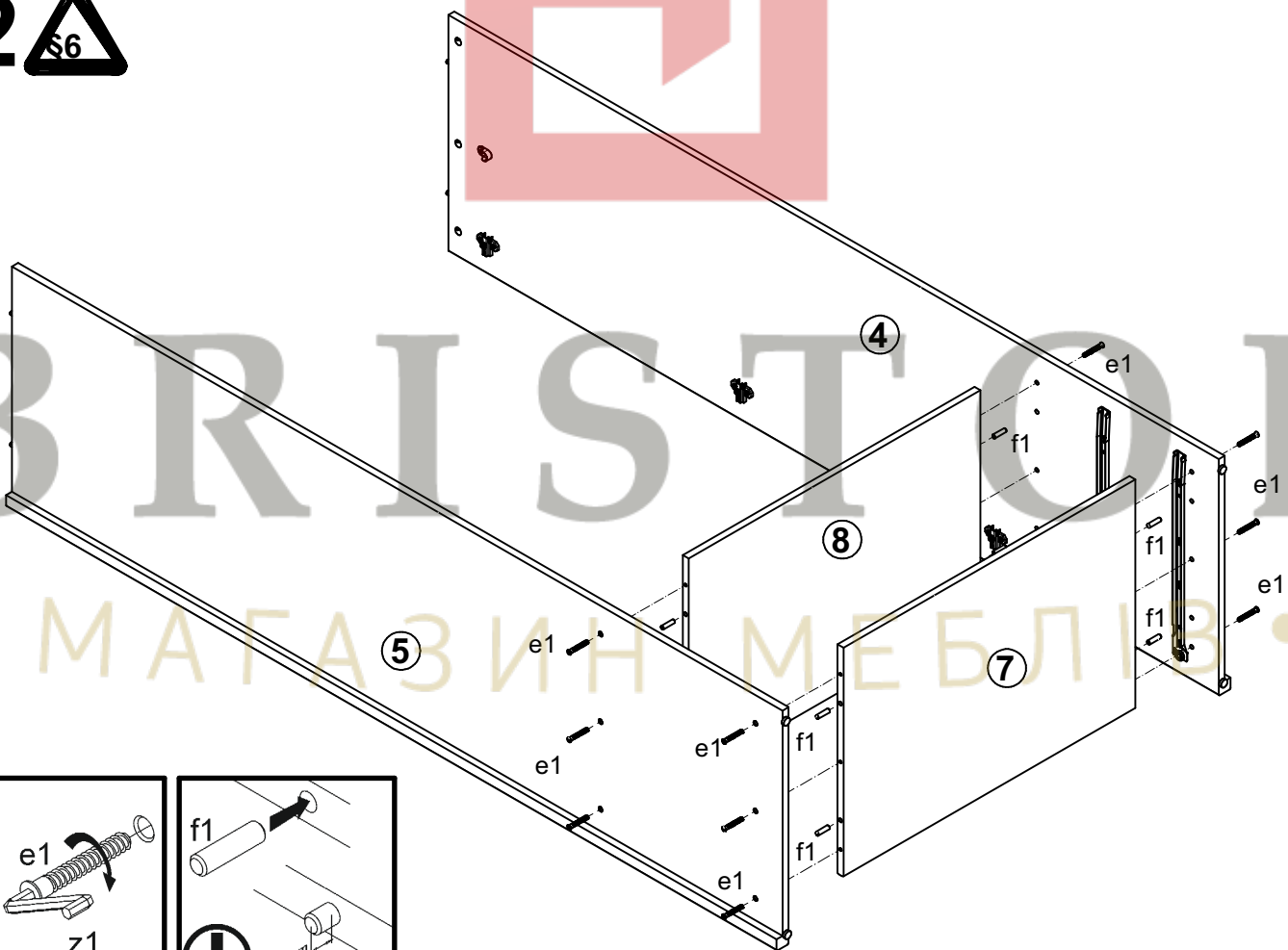

3

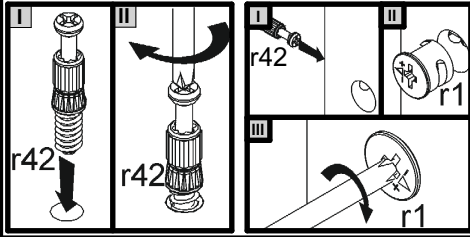
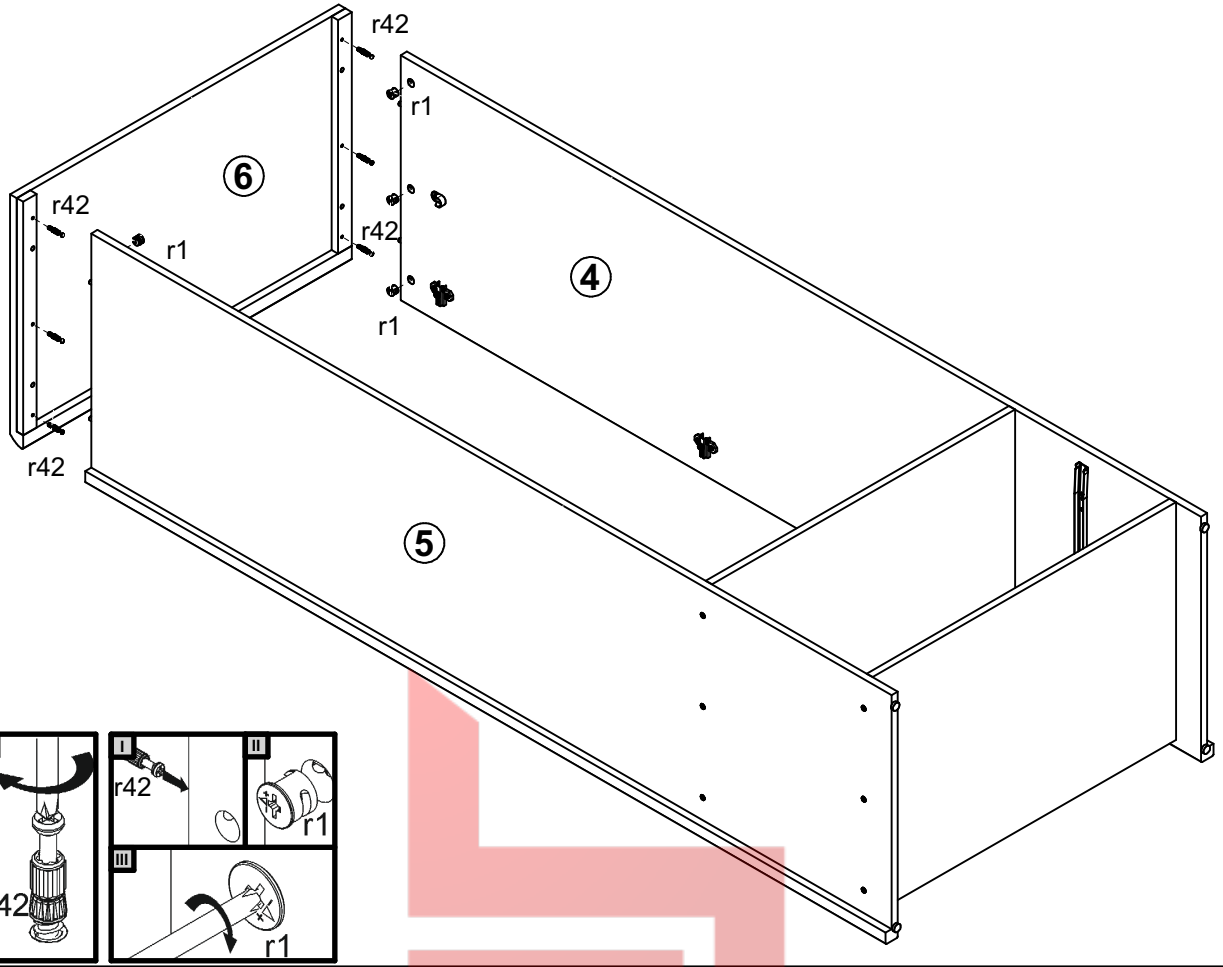

4

