

# КАЛІПСО / КАЛИПСО

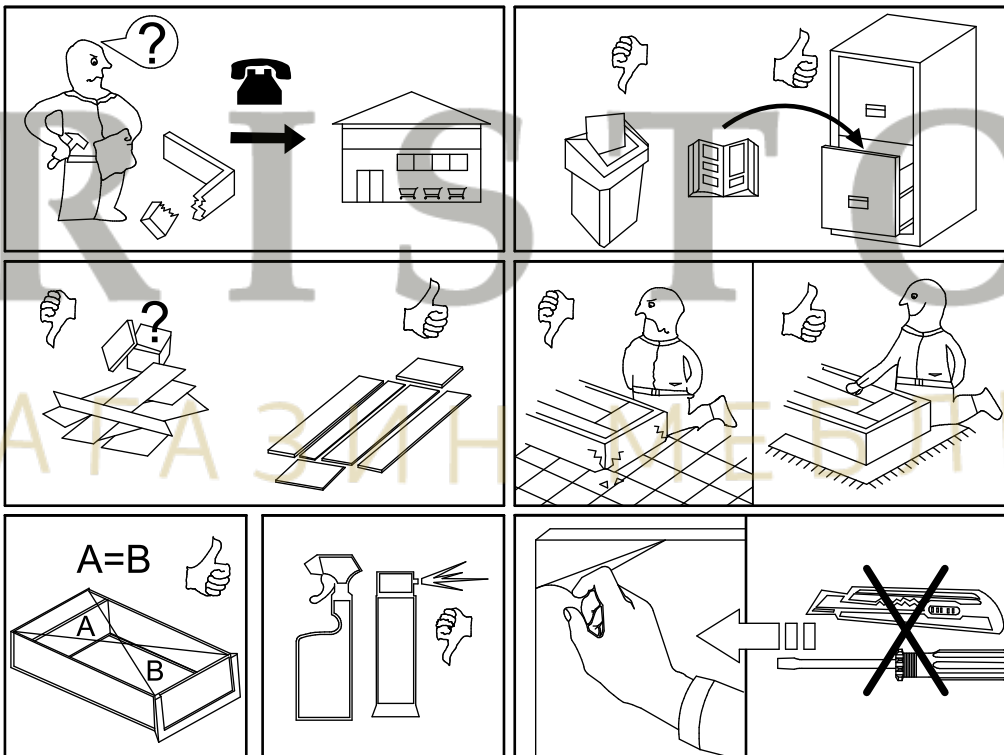

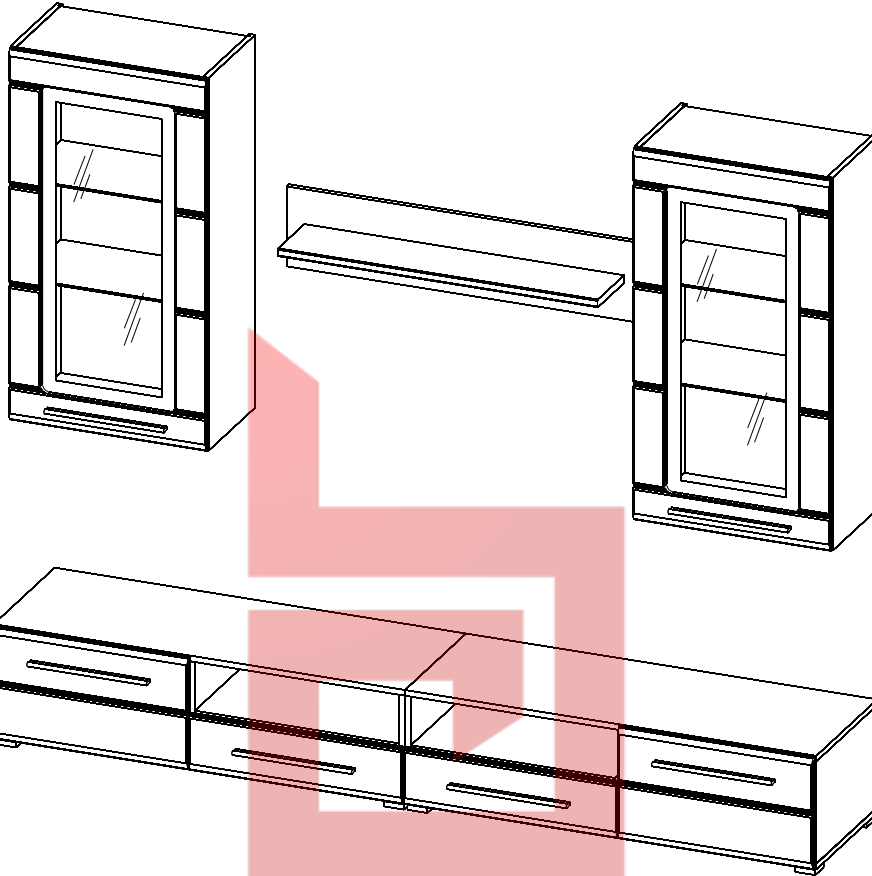

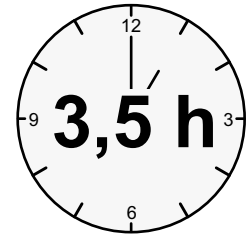
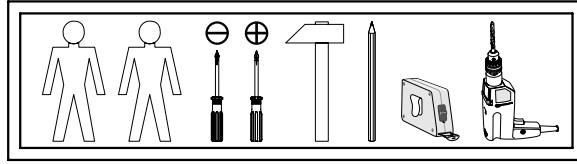
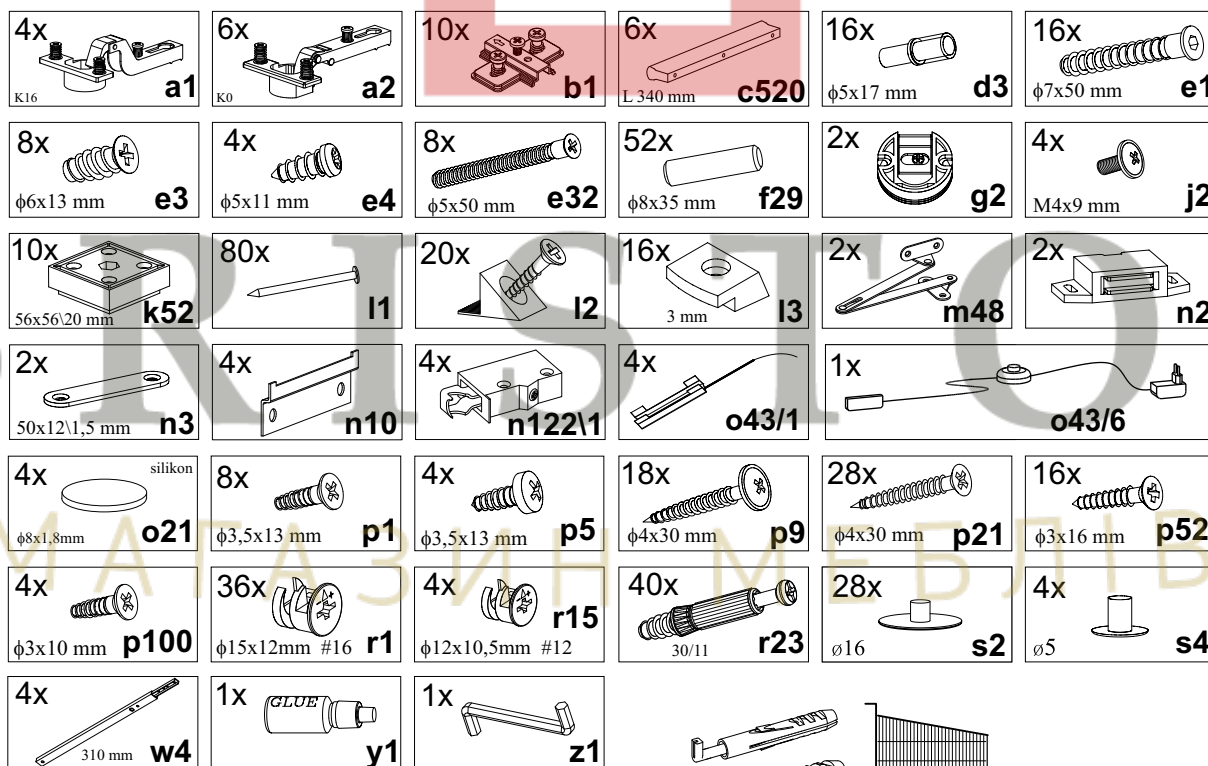
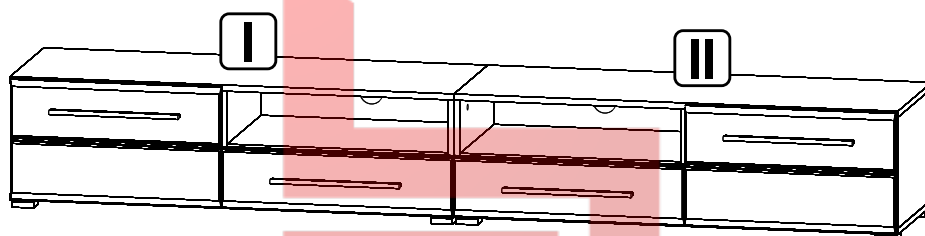
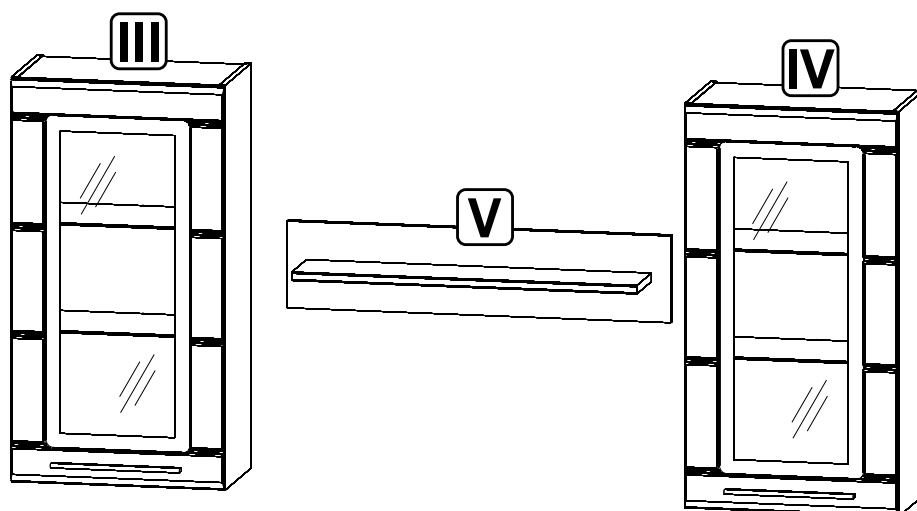

Тумба РТВ ліва / Тумба РТВ левая

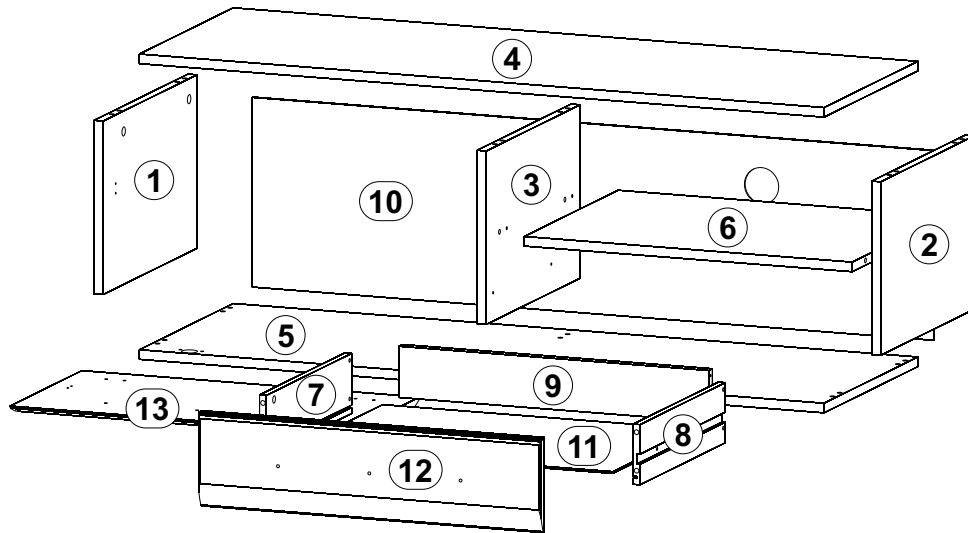

A	B	C	D	A	B	C	D		
1	PU1-101	288	413	1/4	8	PU1-552	375	100	1/4
2	PU1-103	288	413	1/4	9	PU1-553	543	85	1/4
3	PU1-102	288	413	1/4	10	PU1-913	1194	315	1/4
4	PU1-212	1200	413	1/4	11	PU1-904	554	378	1/4
5	PU1-213	1200	413	1/4	12	PU1-003A	600	158	4/4
6	PU1-301	575	413	1/4	13	PU1-014A	592	316	4/4
7	PU1-551	375	100	1/4					



1

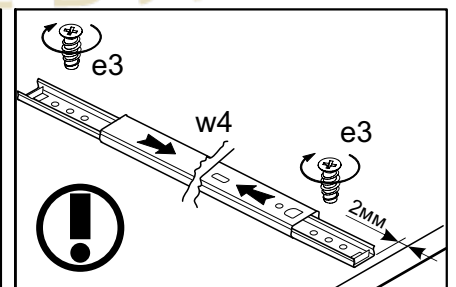
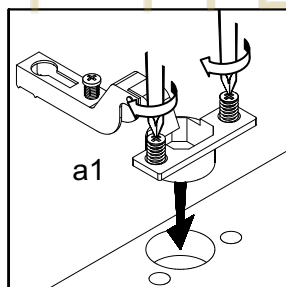
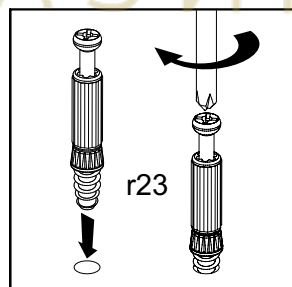
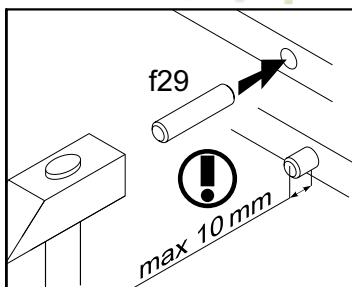
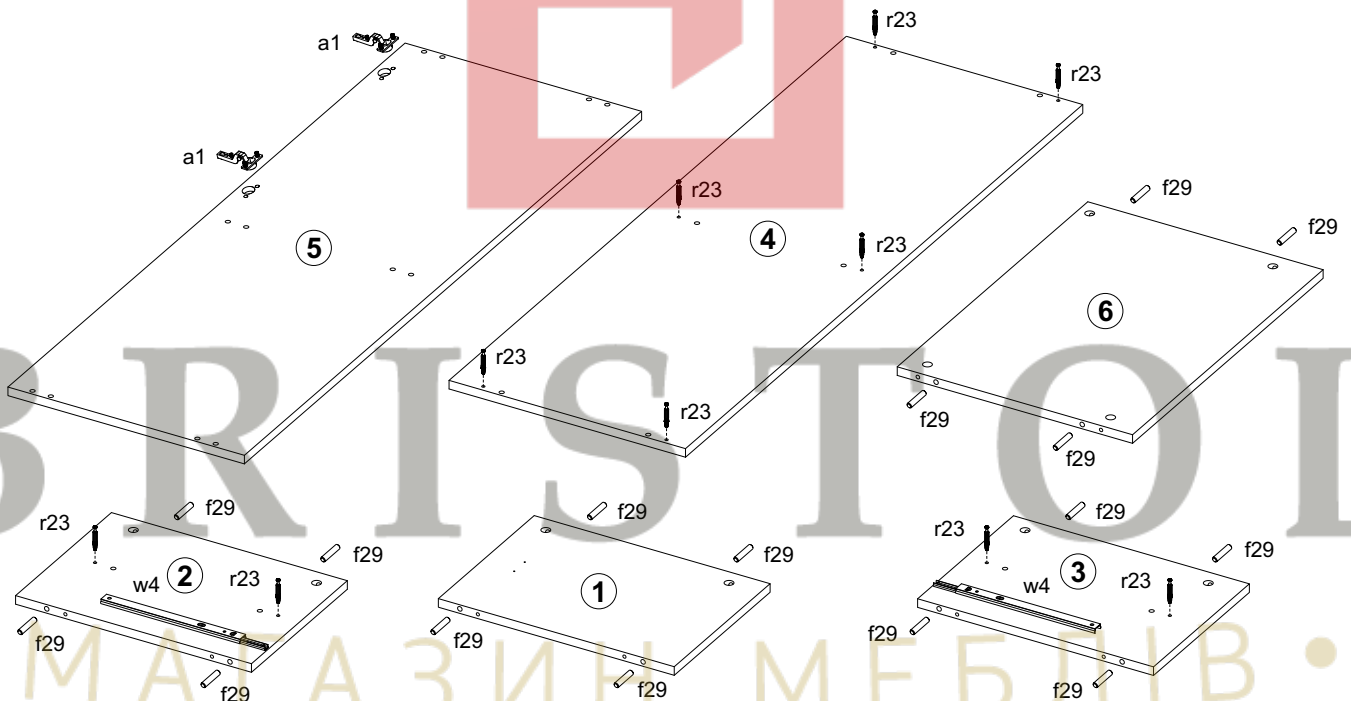
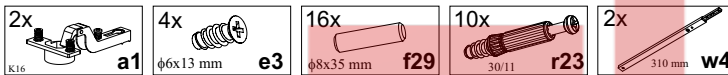

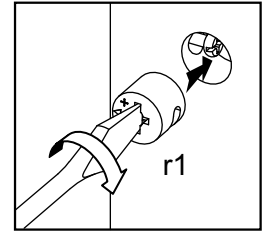
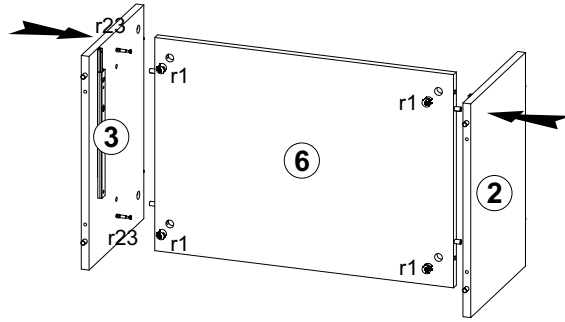
**2**4x  $\phi 15 \times 12 \text{ mm}$  #16 r1**3**6x  $\phi 7 \times 50 \text{ mm}$  e16x  $\phi 15 \times 12 \text{ mm}$  #16 r1

1x z1

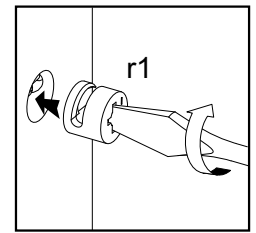
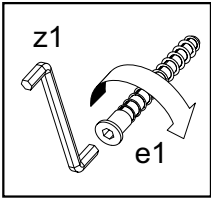
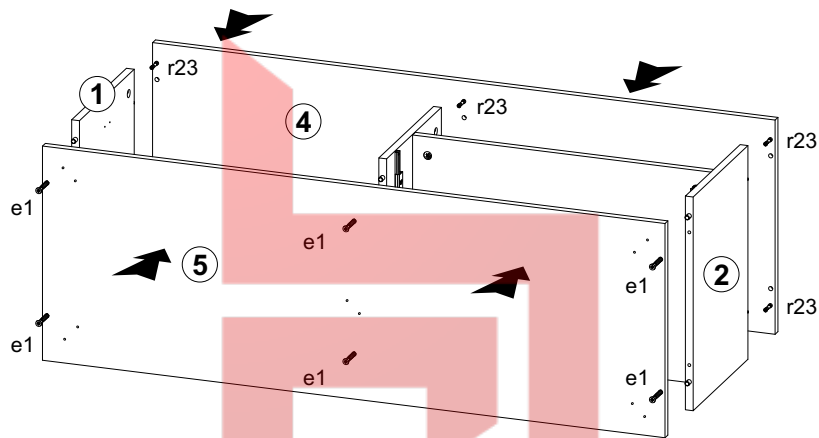
**4**

36x l1

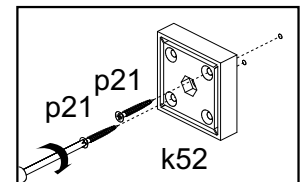
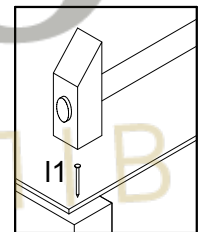
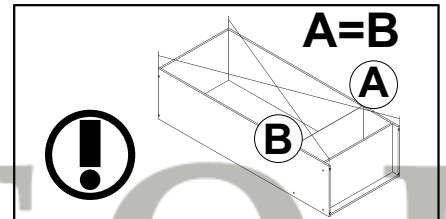
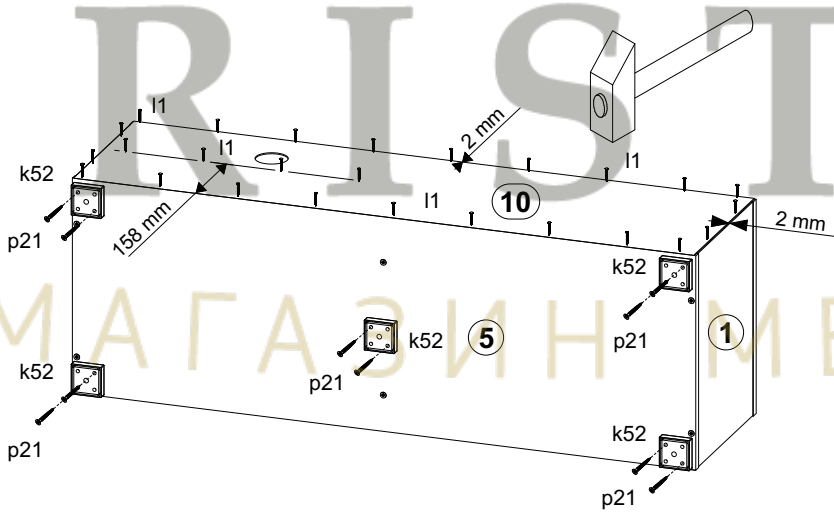
5x  $56 \times 56 \times 20 \text{ mm}$  k5210x  $\phi 4 \times 30 \text{ mm}$  p21

# 5

- 4x  $\phi 5 \times 50$  mm e32
- 2x  $\phi 8 \times 35$  mm f29
- 6x I1
- 2x I2
- 2x  $\phi 12 \times 10,5$  mm #12
- 2x 3011 r23
- 1x y1

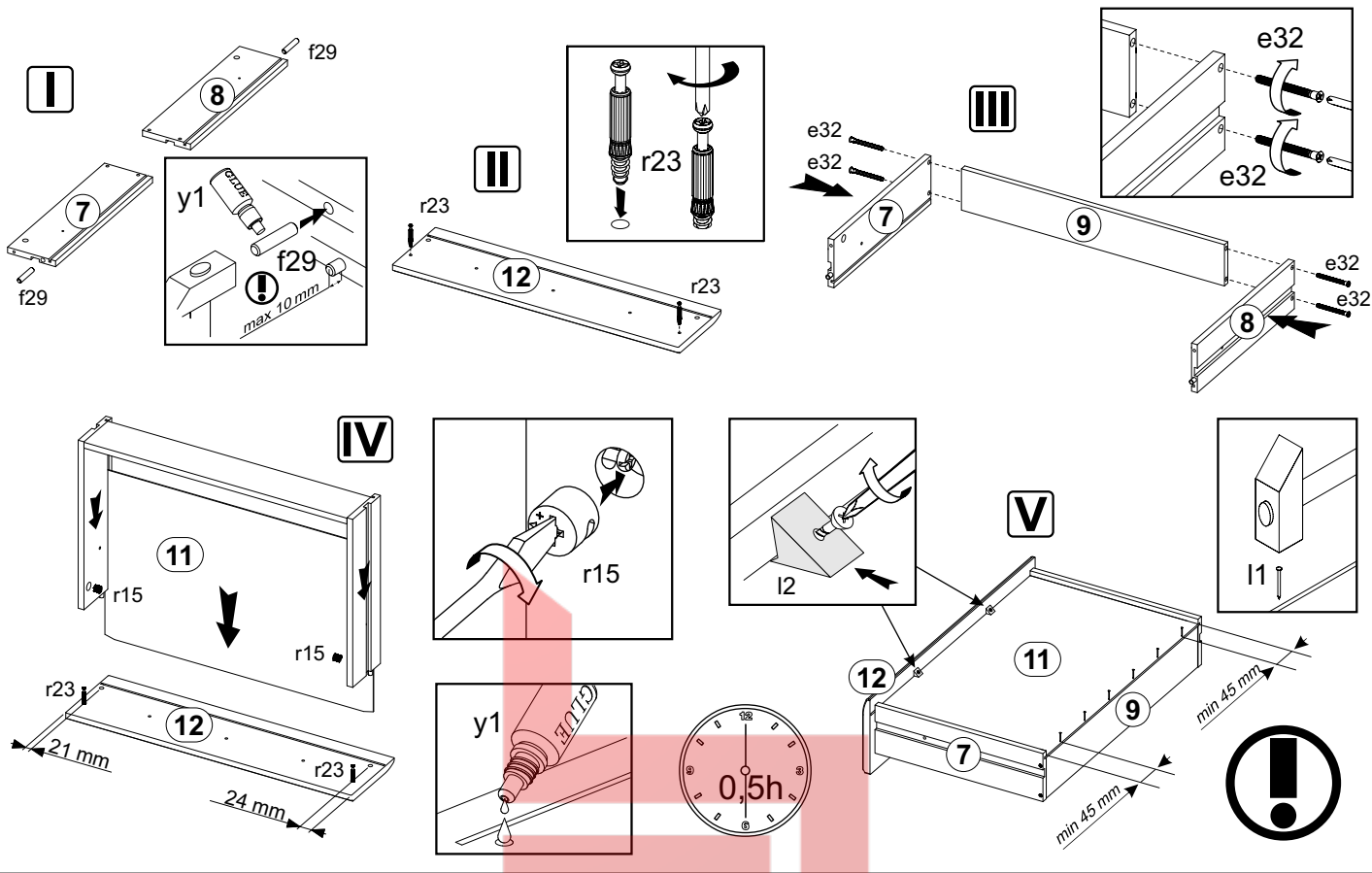

# 6

- 2x L 340 mm c520
- 2x M4x9 mm j2
- 1x m48
- 4x  $\phi 3,5 \times 13$  mm p1
- 6x  $\phi 4 \times 30$  mm p9
- 6x  $\phi 16$  s2

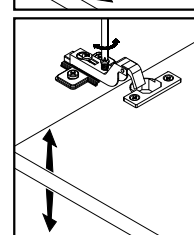
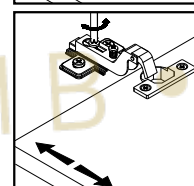
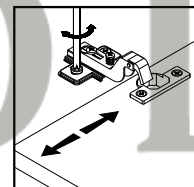
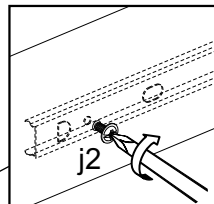
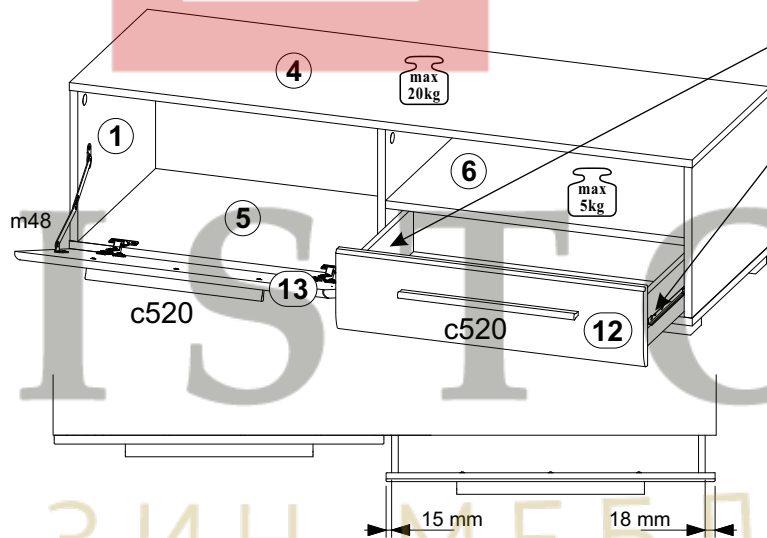
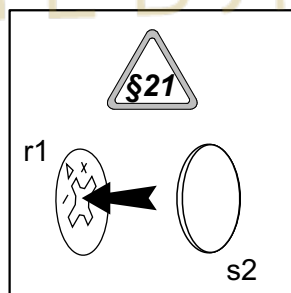
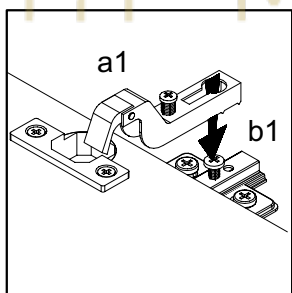
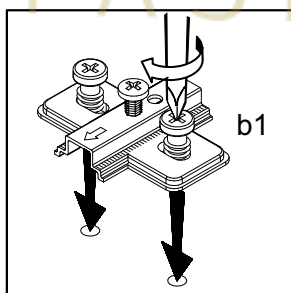
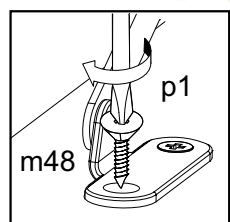
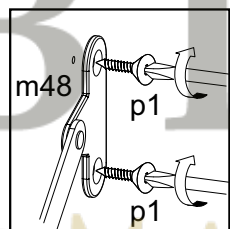
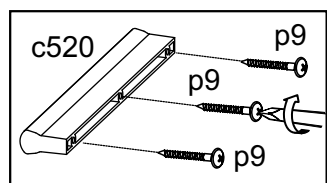



Тумба РТВ права / Тумба РТВ правая

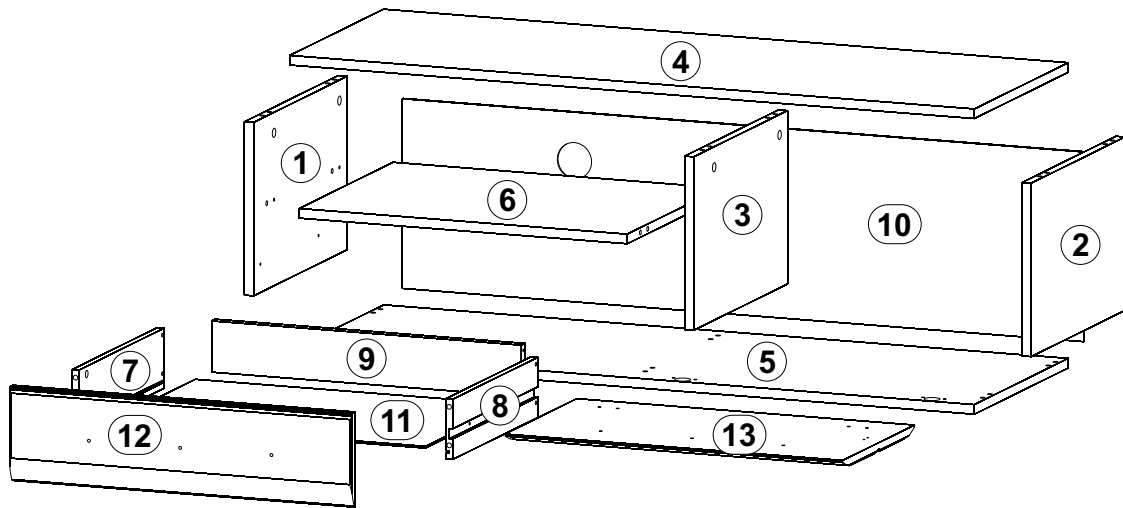







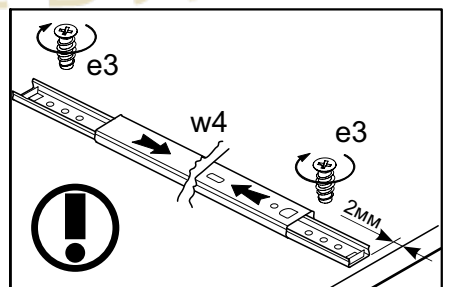
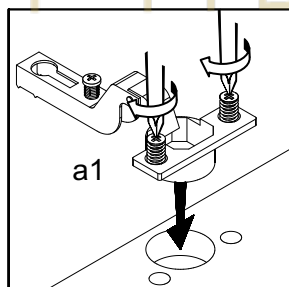
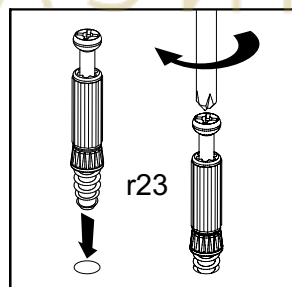
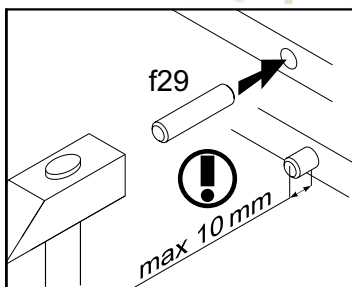
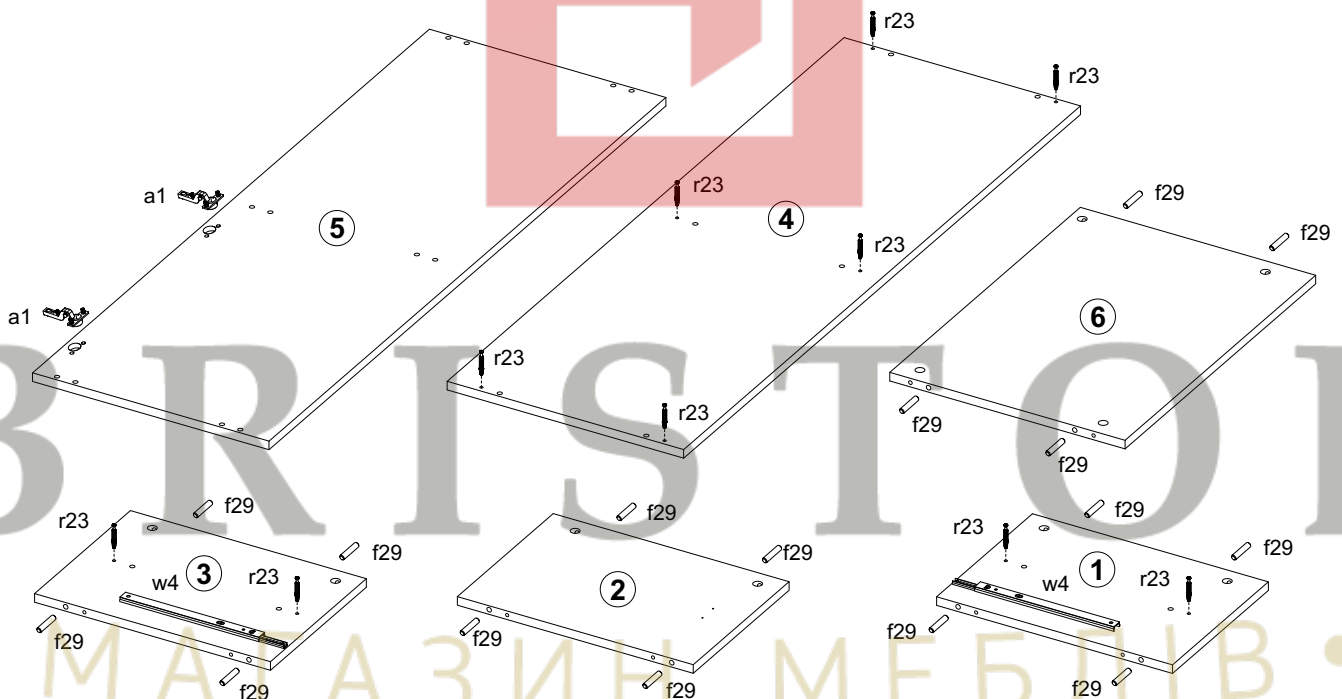
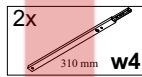
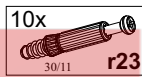
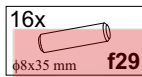
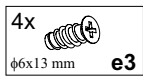
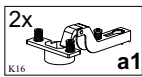

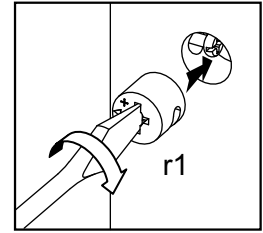
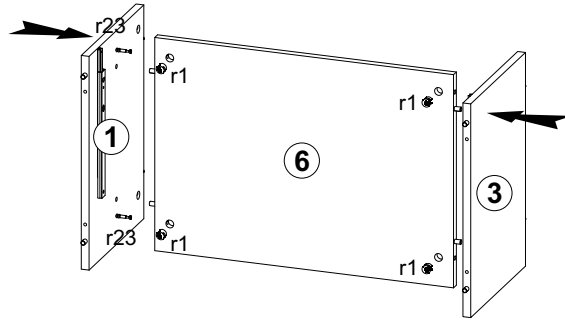
A	B	C	D	A	B	C	D		
1	PU1-104	288	413	2/4	8	PU1-552	375	100	2/4
2	PU1-106	288	413	2/4	9	PU1-553	543	85	2/4
3	PU1-105	288	413	2/4	10	PU1-914	1194	315	2/4
4	PU1-214	1200	413	2/4	11	PU1-904	554	378	2/4
5	PU1-215	1200	413	2/4	12	PU1-005A	600	158	4/4
6	PU1-301	575	413	2/4	13	PU1-015A	592	316	4/4
7	PU1-551	375	100	2/4					

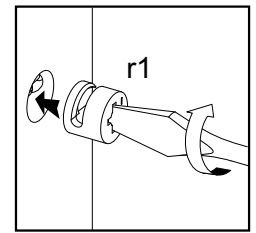
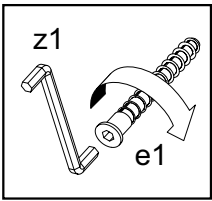
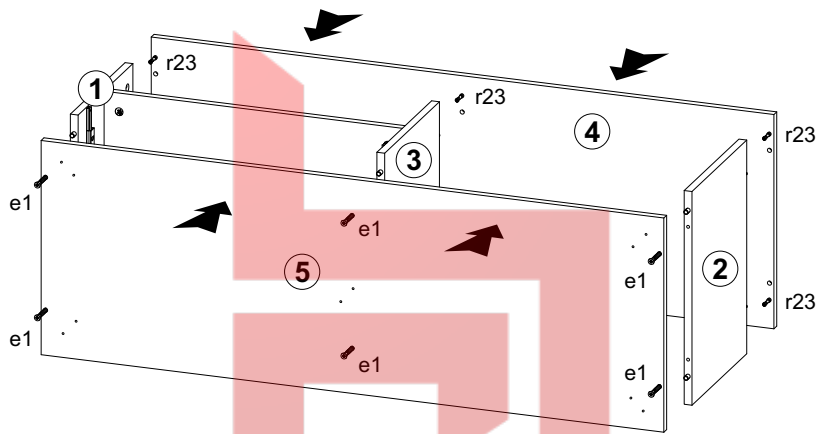

7

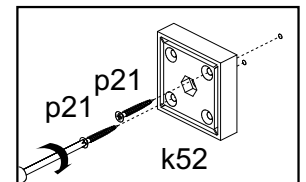
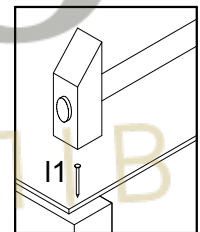
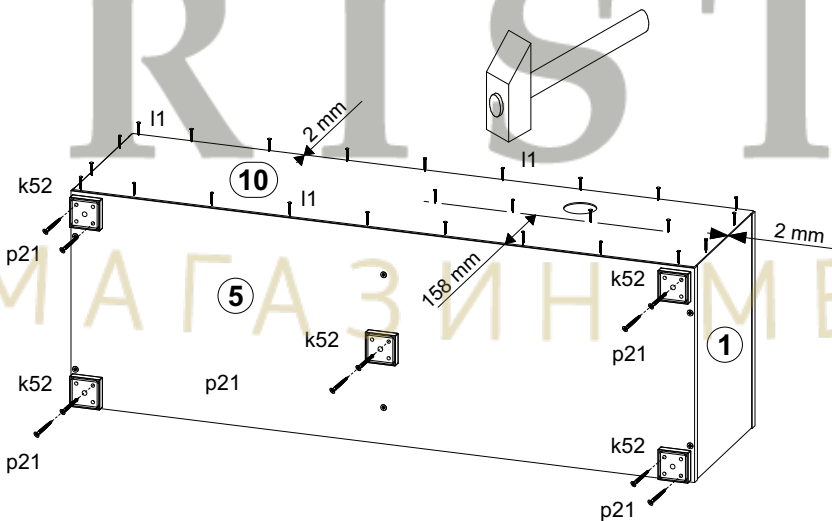
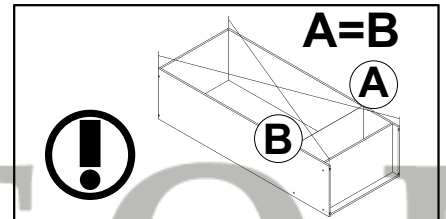

**8**4x   $\phi 15 \times 12 \text{ mm}$  #16 r1**9**6x   $\phi 7 \times 50 \text{ mm}$  e16x   $\phi 15 \times 12 \text{ mm}$  #16 r11x  z1**10**36x  l15x  56x56/20 mm k5210x   $\phi 4 \times 30 \text{ mm}$  p21

# 11

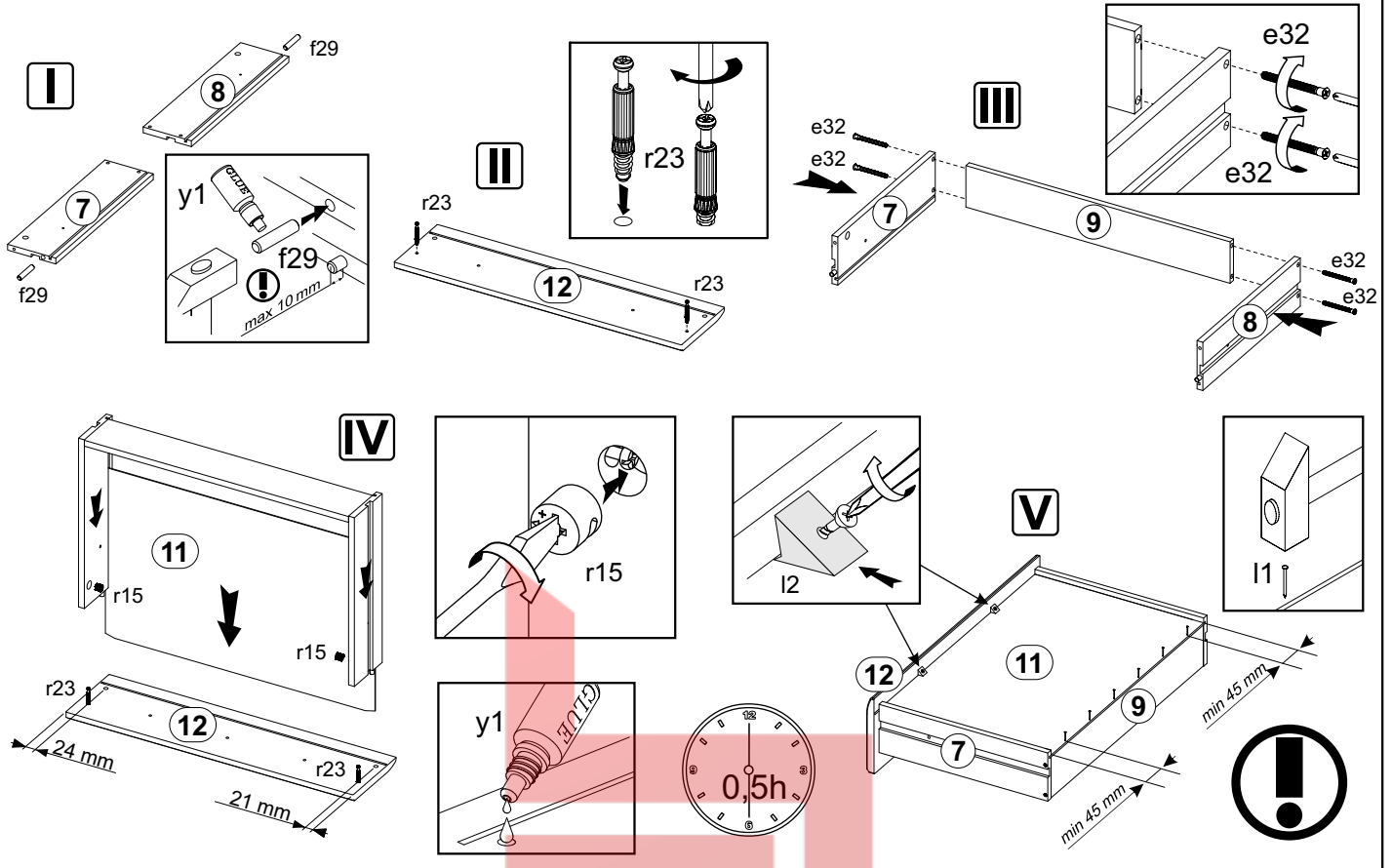
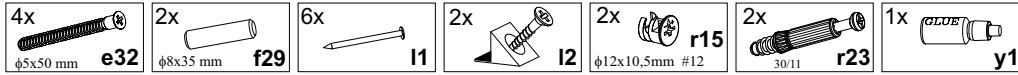

# 12

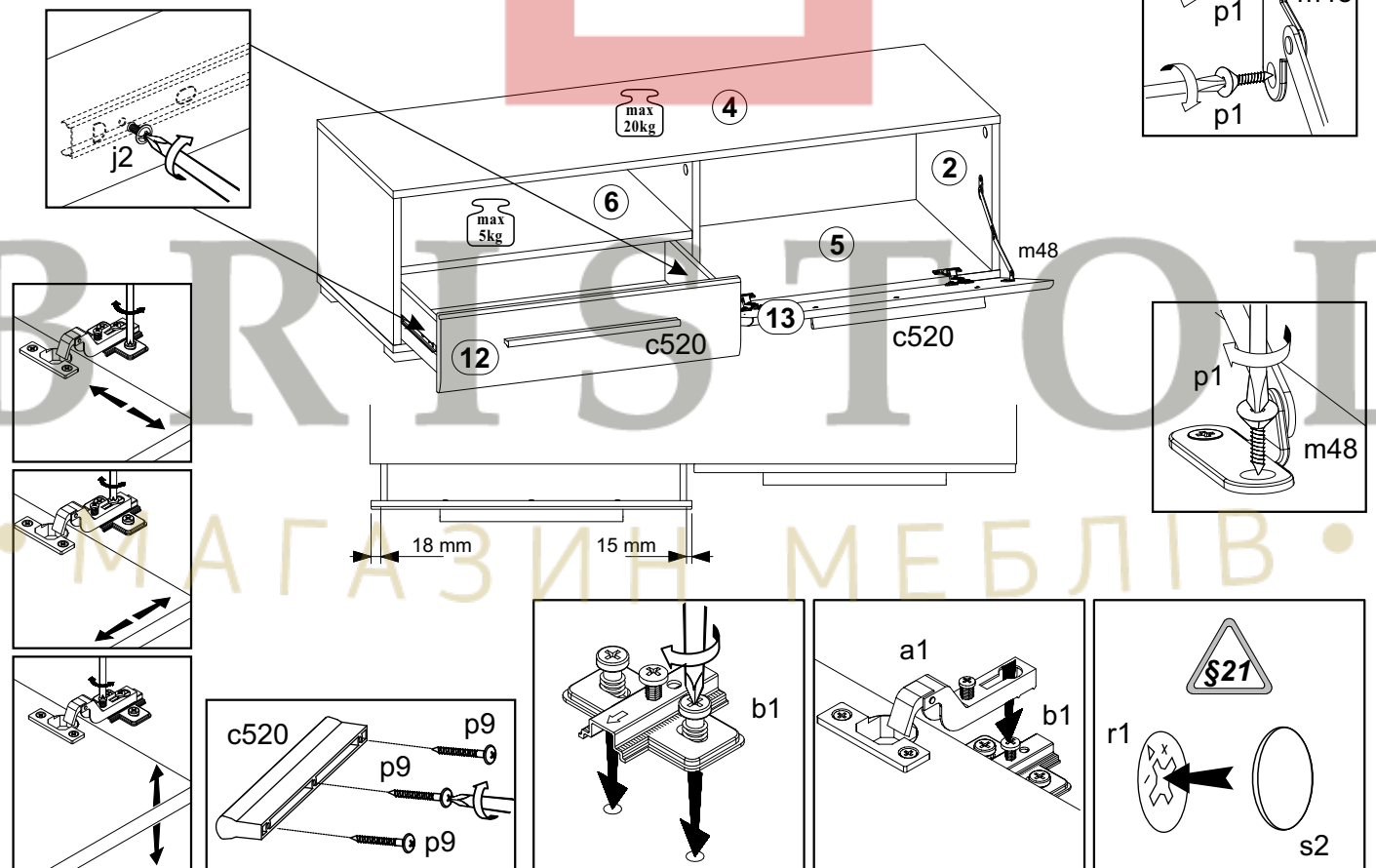
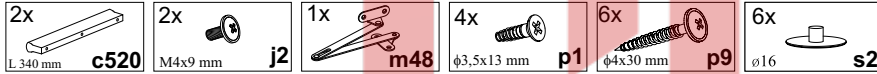





Вітрина навісна ліва / Витрина навесная левая

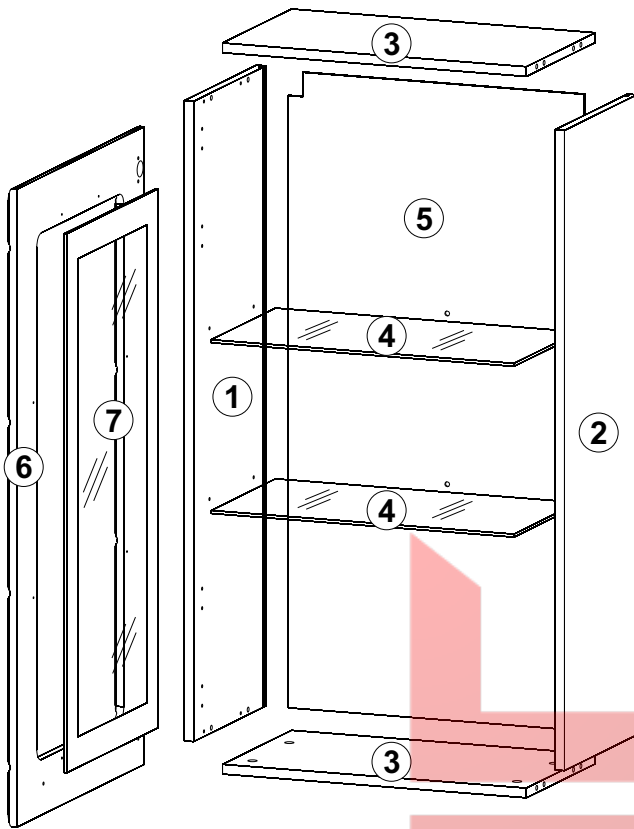

A	B	C	D	
1	PU1-113-01	1050	314	3/4
2	PU1-108-01	1050	314	3/4
3	PU1-309	568	300	3/4
4	PU1-310	565	279	3/4
5	PU1-912	1044	579	4/4
6	PU1-012A	1046	596	4/4
7	PU1-501	884	398	4/4

13

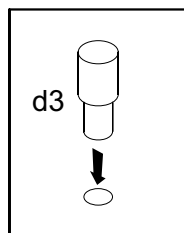
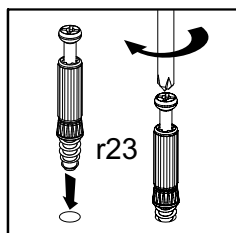
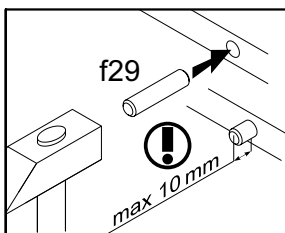
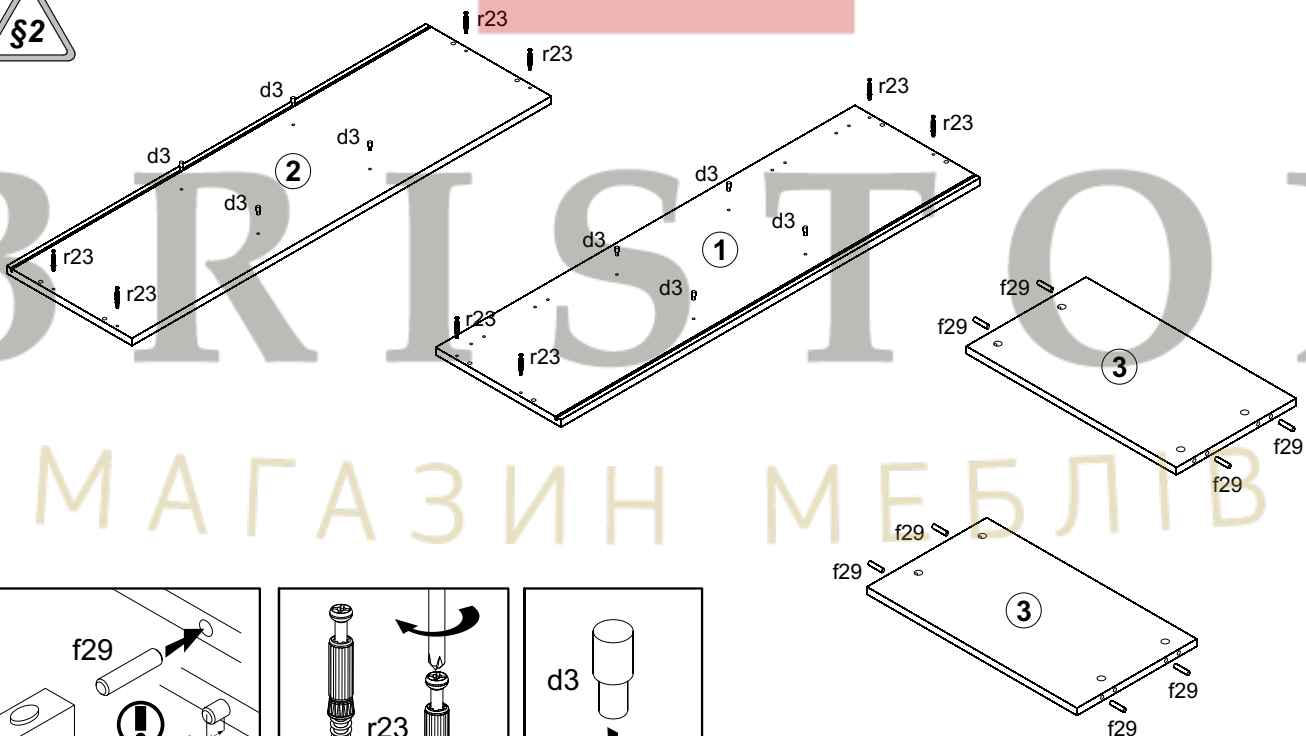
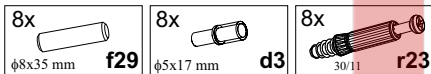

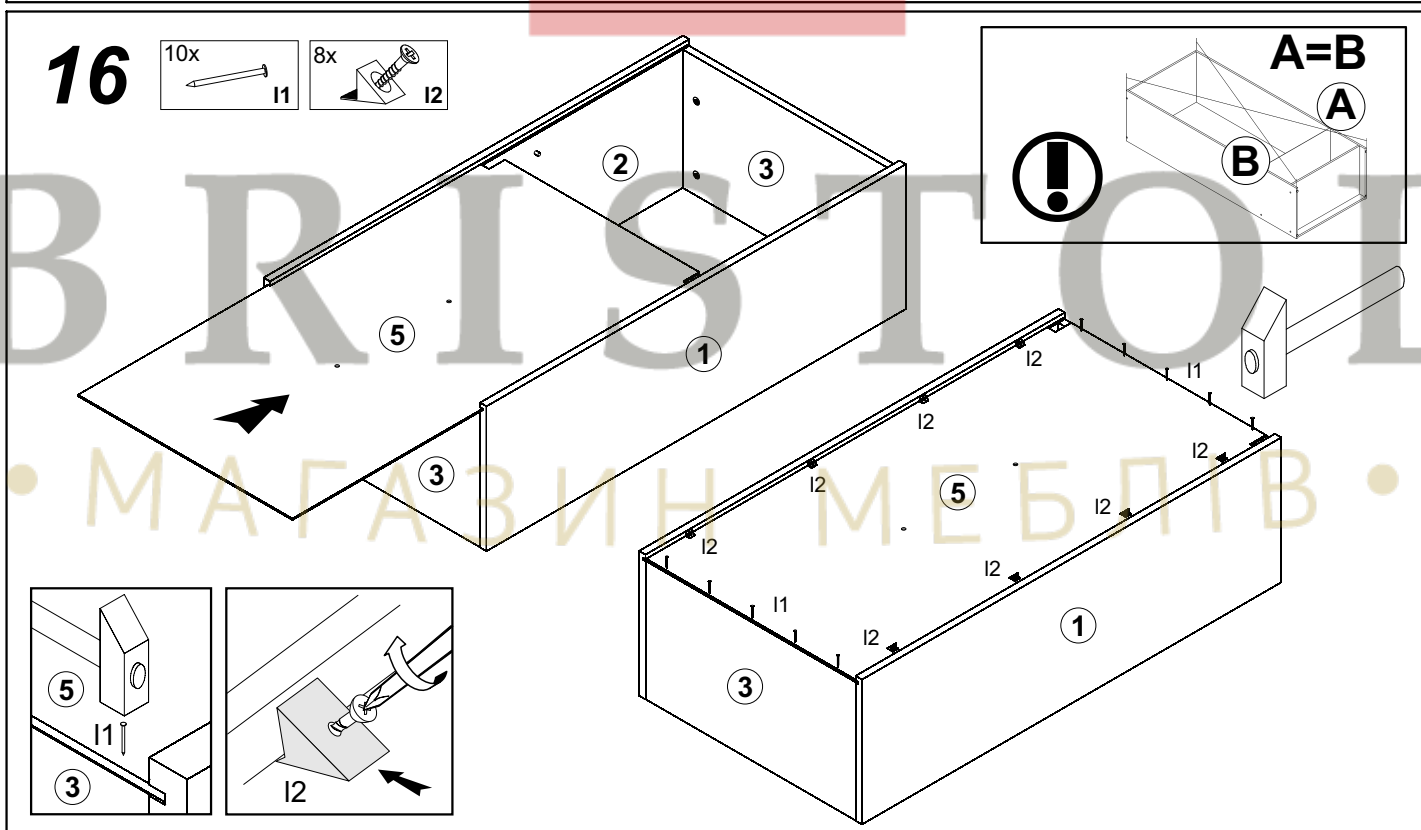
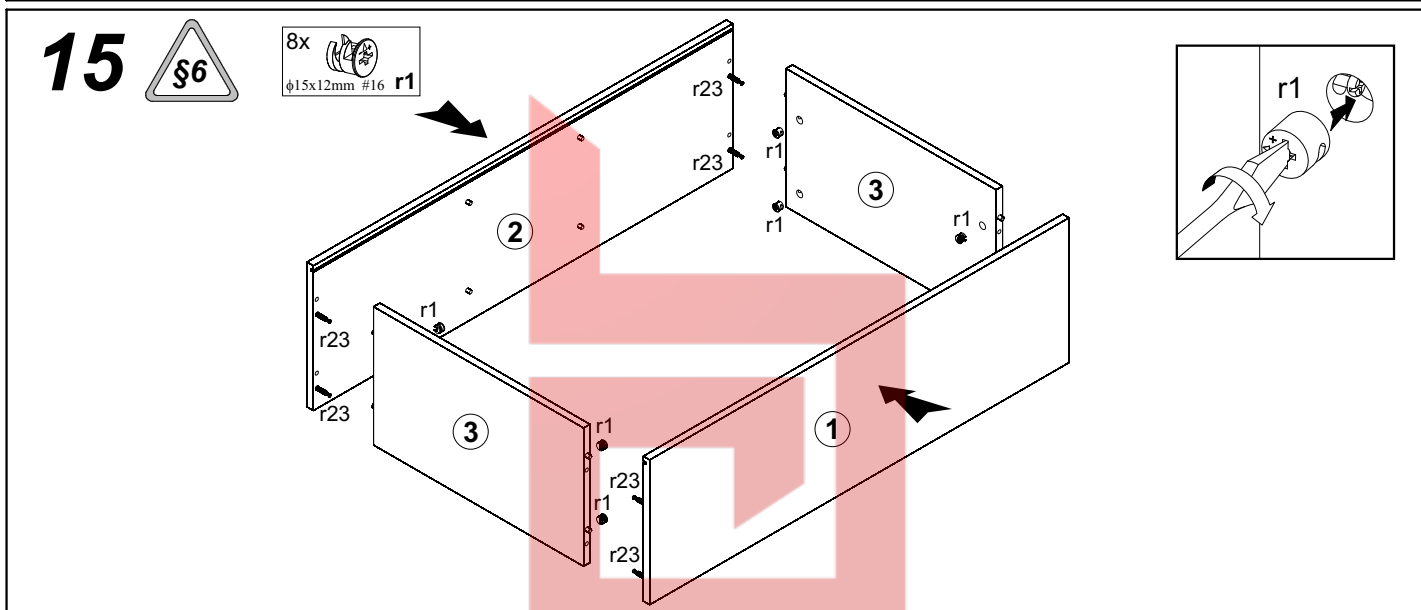
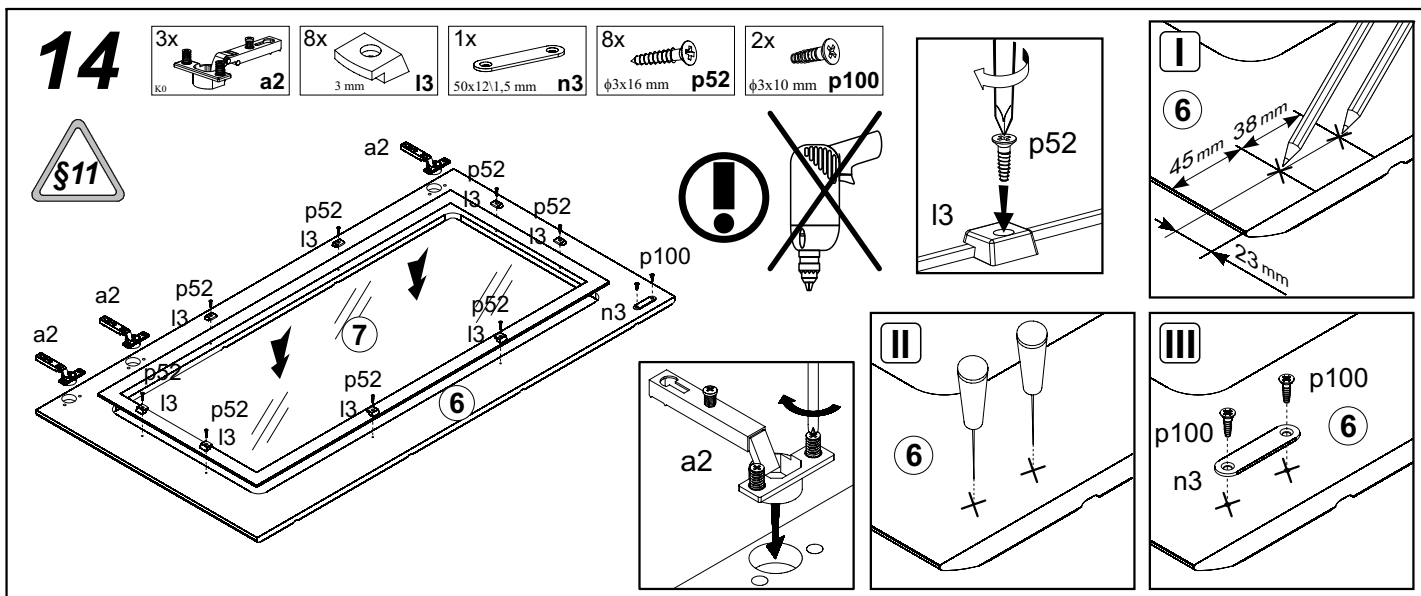

# 17

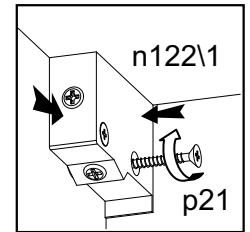
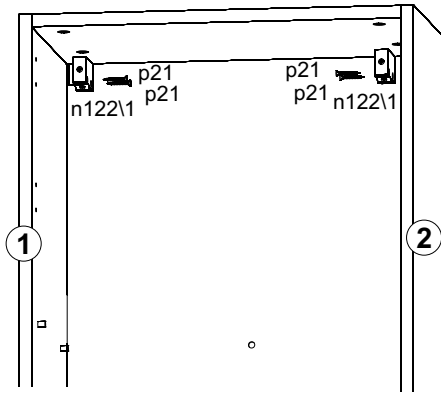
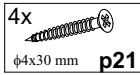
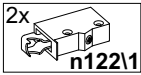

# 18

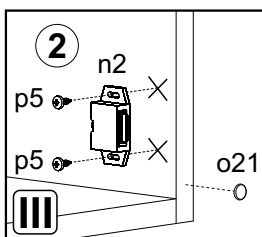
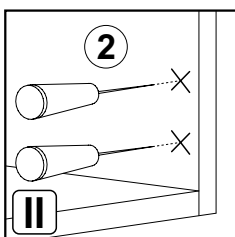
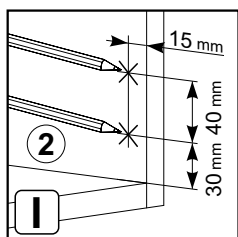
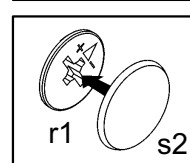
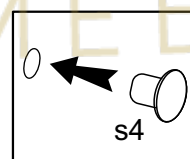
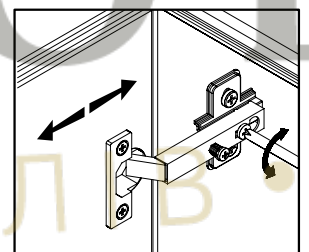
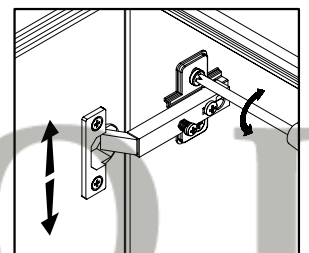
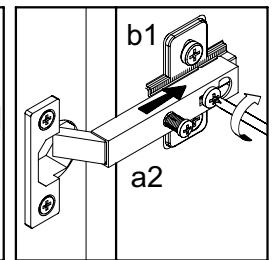
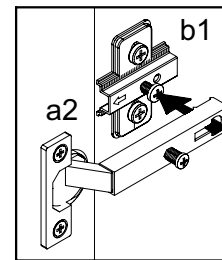
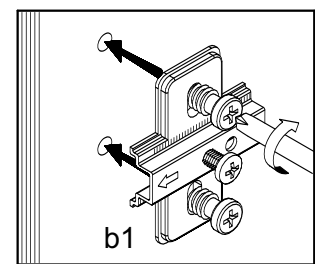
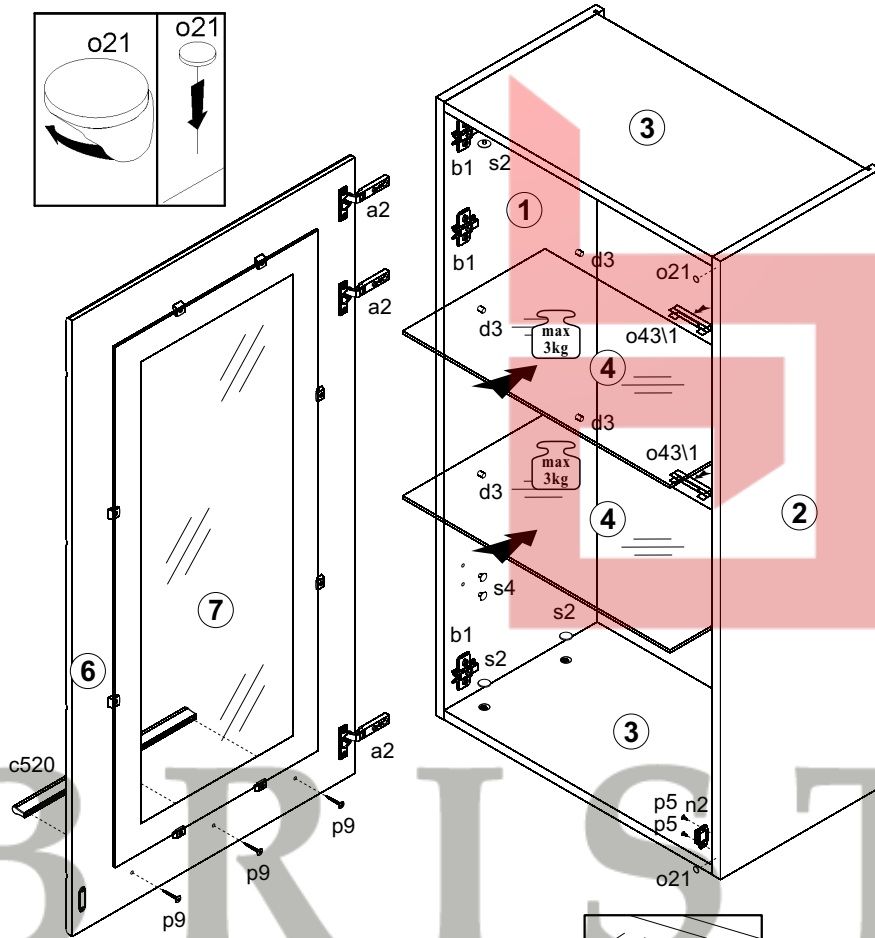
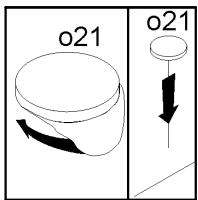
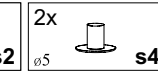
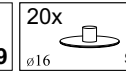
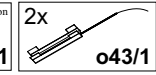
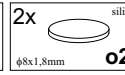
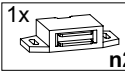
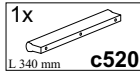

**IV**

Вітрина навісна права / Витрина навесная правая

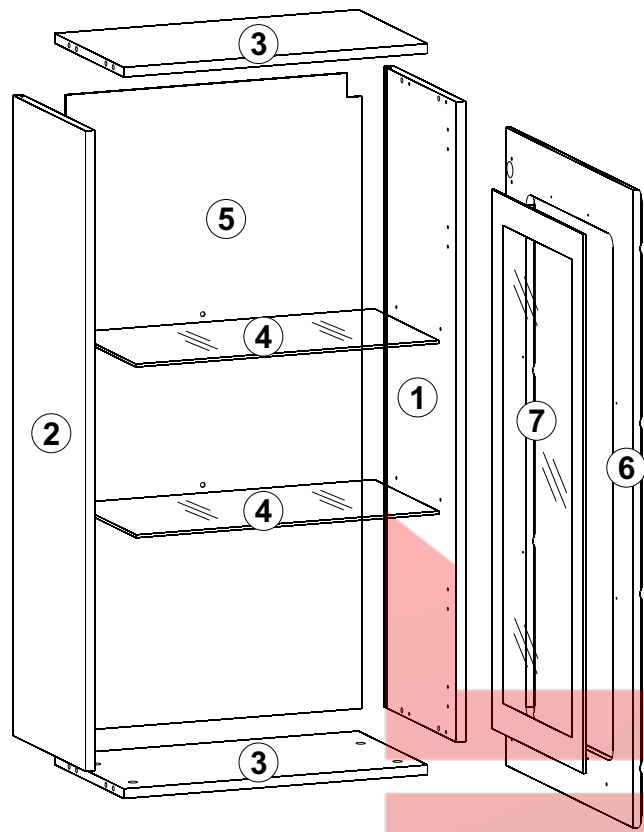

A	B	C	D
1	PU1-113-01	1050	314 3/4
2	PU1-108-01	1050	314 3/4
3	PU1-309	568	300 3/4
4	PU1-310	565	279 3/4
5	PU1-912	1044	579 4/4
6	PU1-013A	1046	596 4/4
7	PU1-501	884	398 4/4

**19**

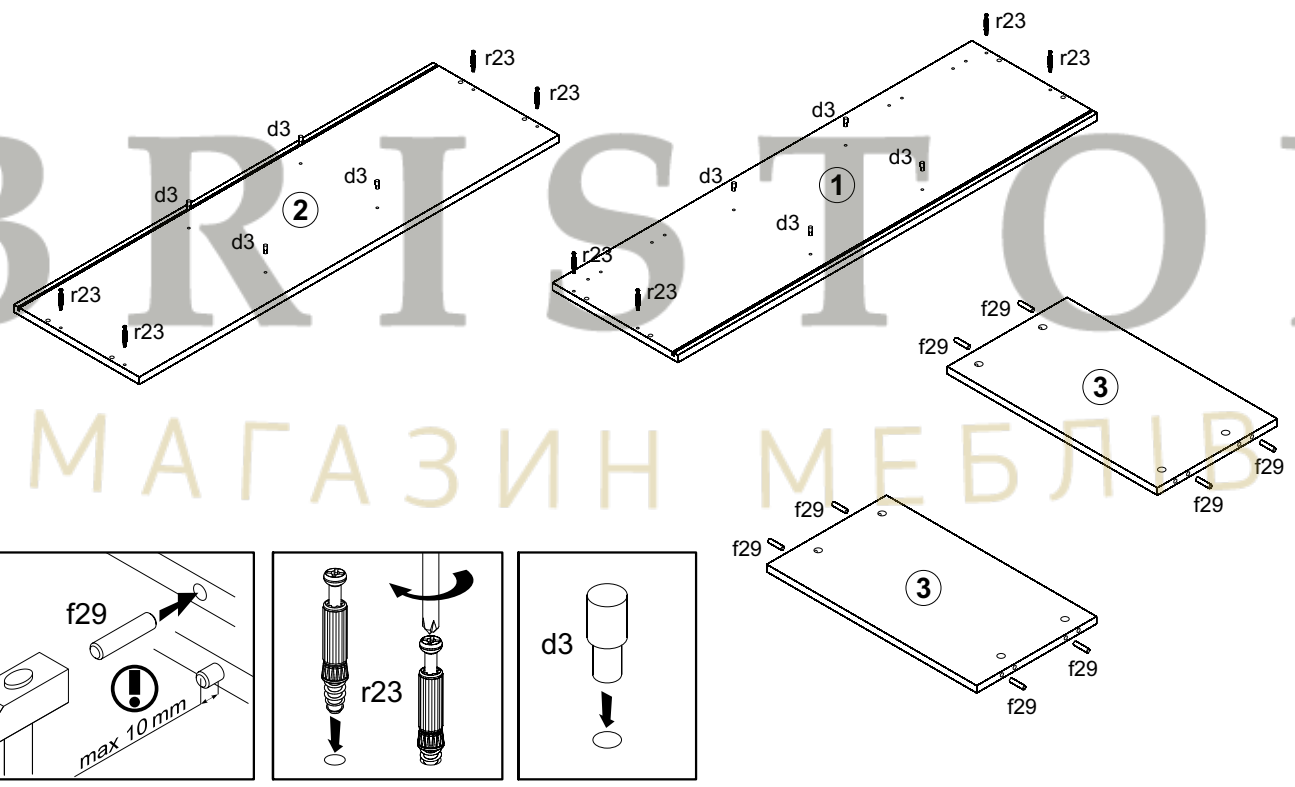
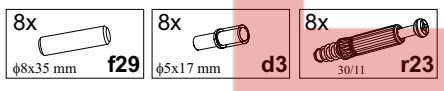

# 20

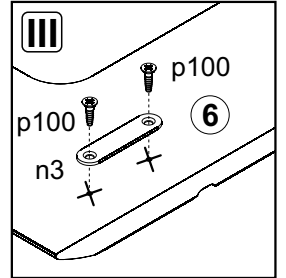
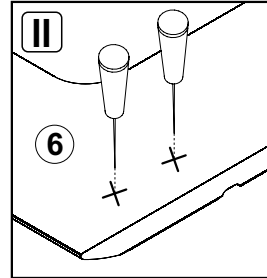
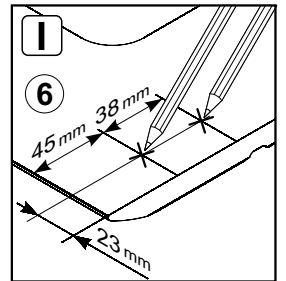
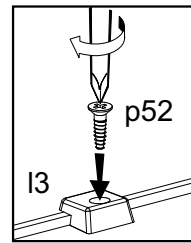
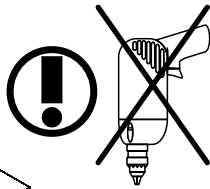
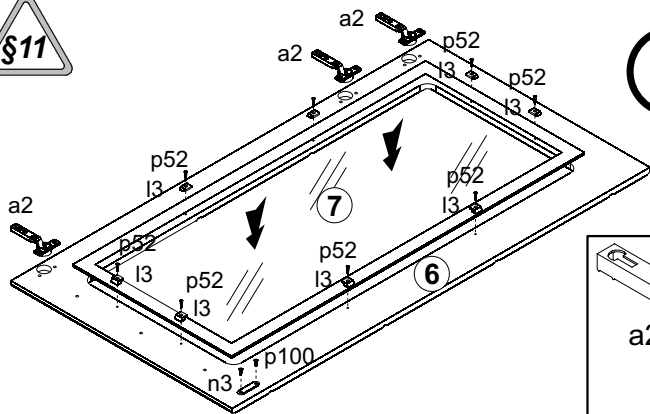
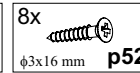
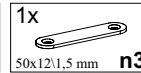
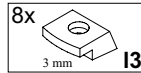
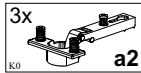

# 21

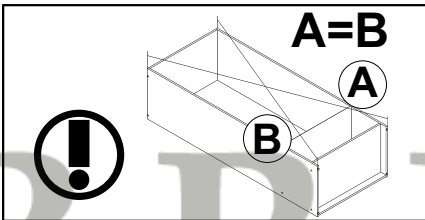
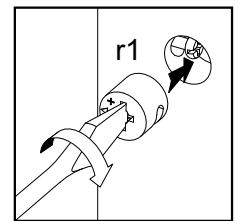
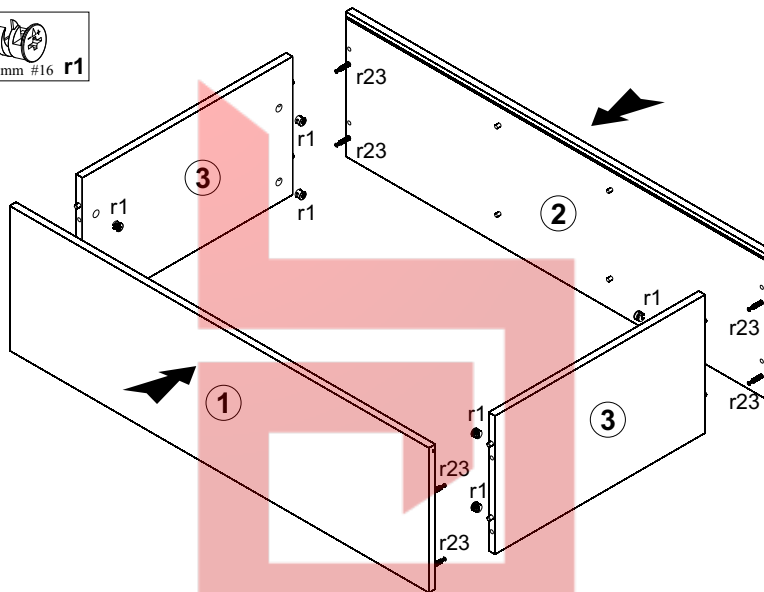
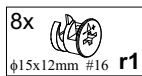

# 22

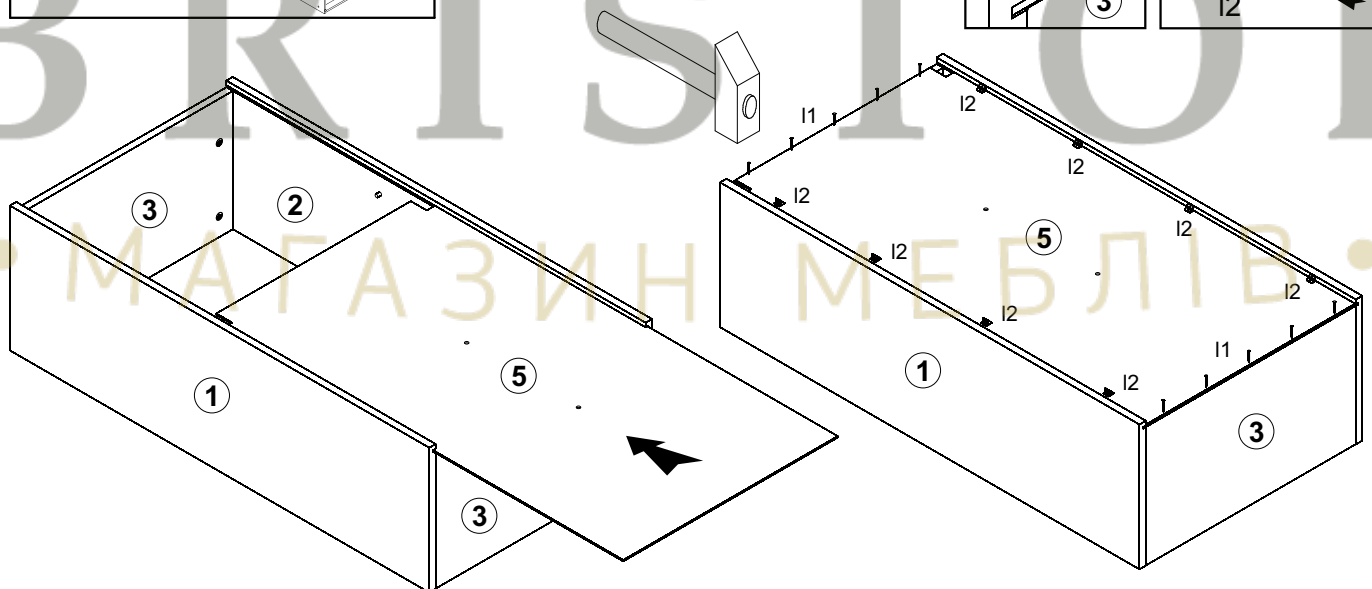
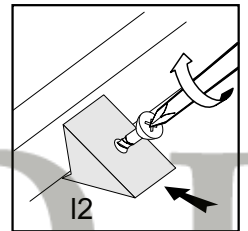
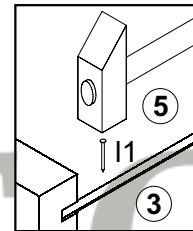
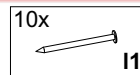

# 23

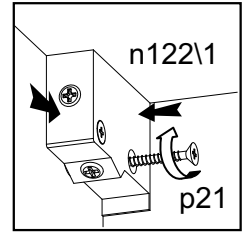
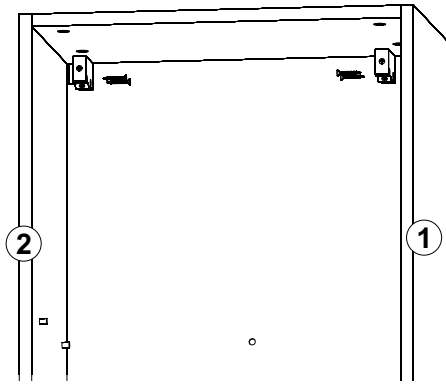
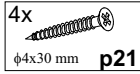
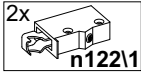

# 24

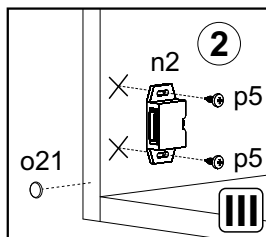
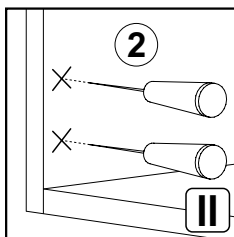
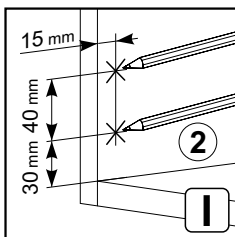
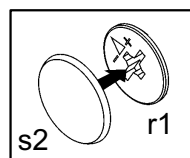
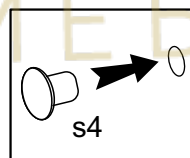
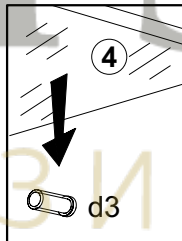
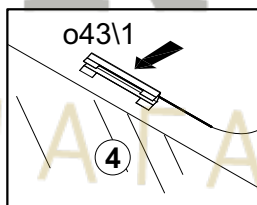
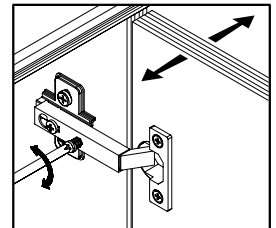
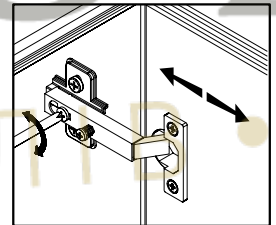
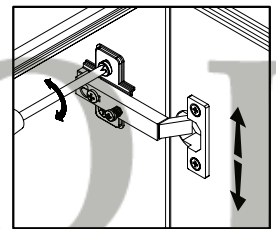
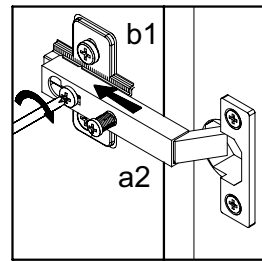
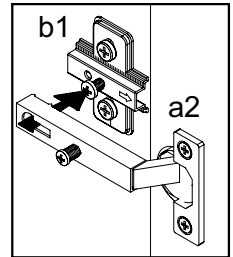
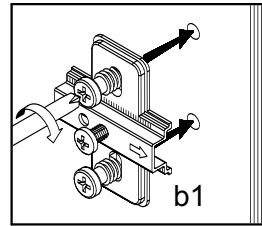
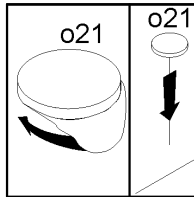
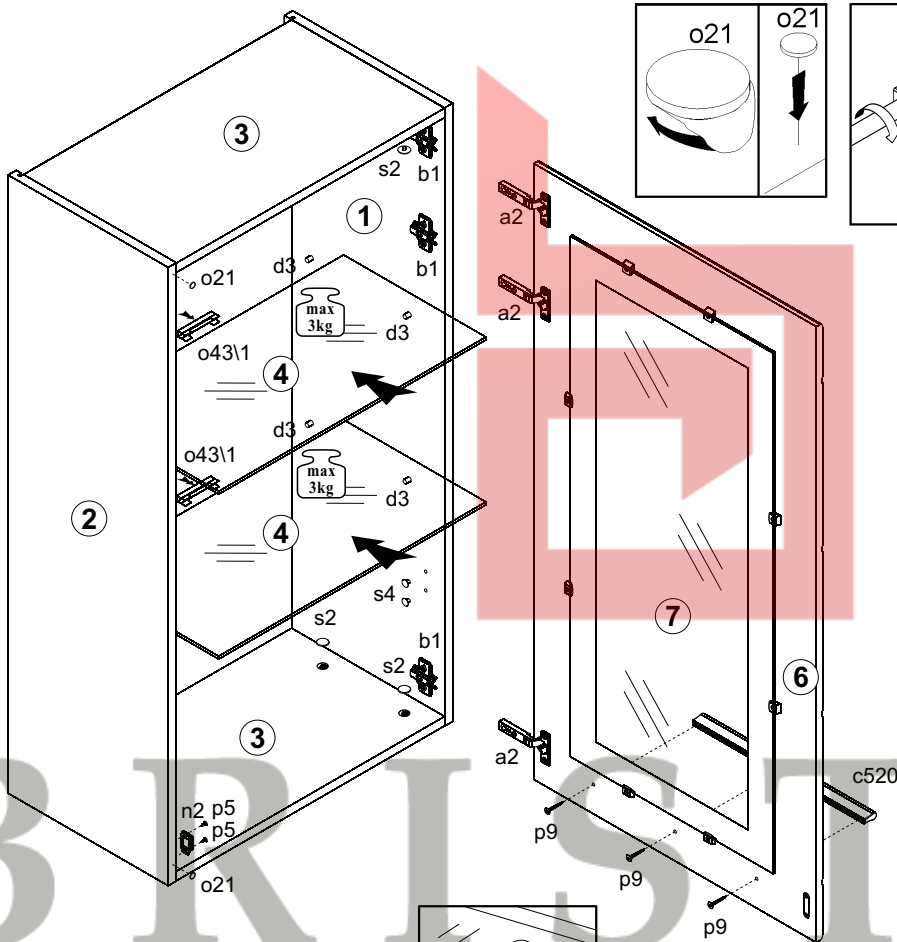
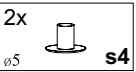
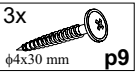
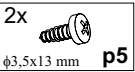
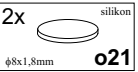
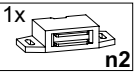
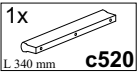

**V** Полиця / Полка

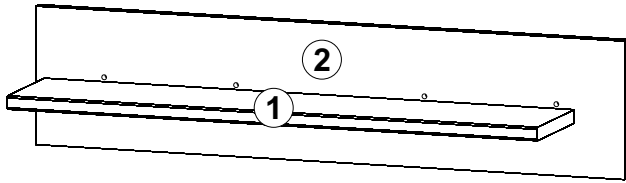

A	B	C	D
1	PU1-306	900	180
2	PU1-401	225	1000



**25**

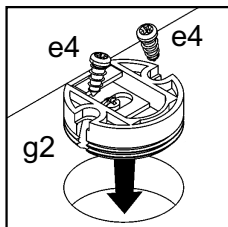
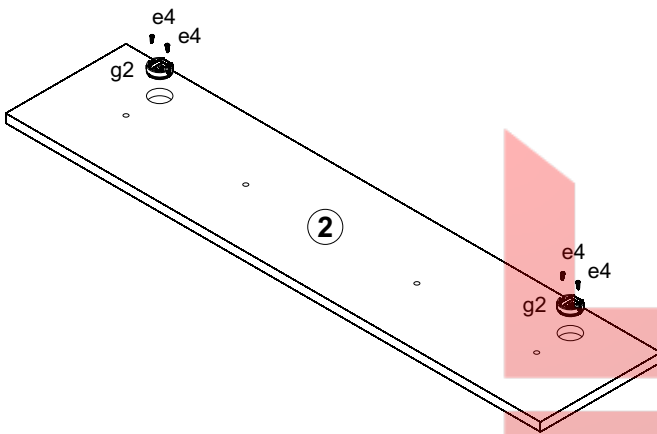
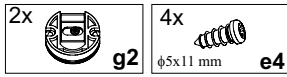

**26**

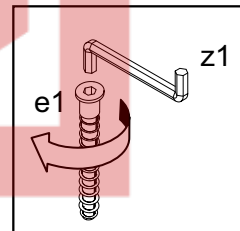
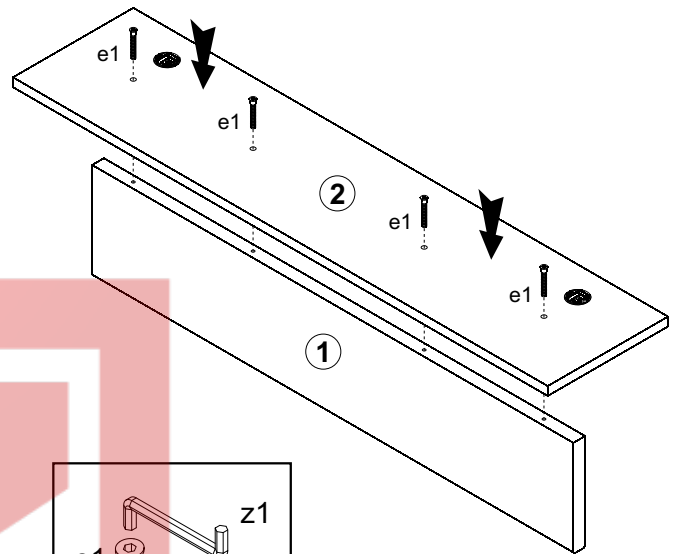
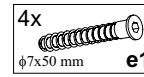

**27**

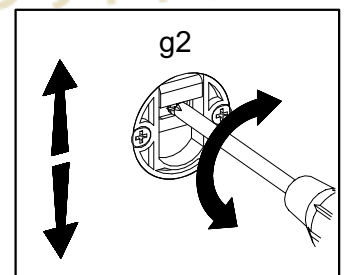
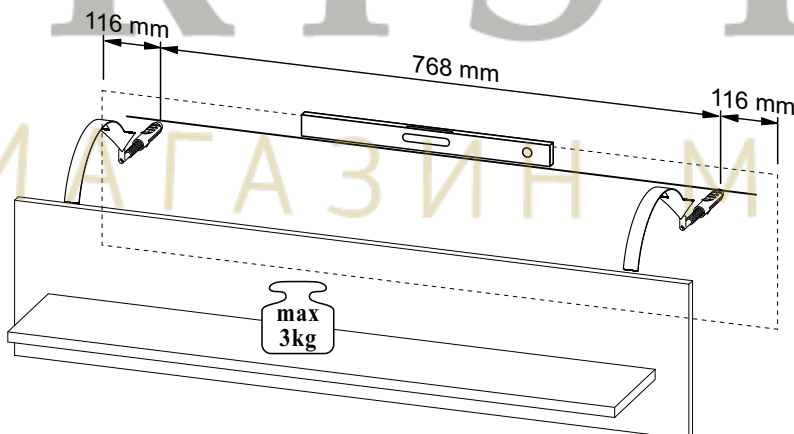
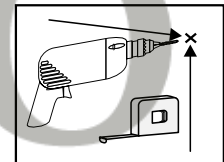
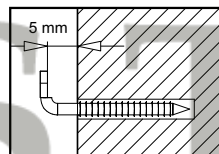
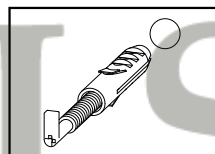

28

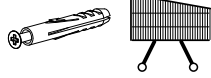
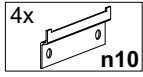

25 mm

64 mm

64 mm

25 mm

