

A	B	C	D
1	S52-011A	496	167 3/3
2	S52-118	1988	370 1/3
3	S52-119	1988	370 1/3
4	S52-206	500	395 2/3
5	S52-309	467	370 2/3
6	S52-310	467	365 2/3
7	S52-408	467	80 2/3
8	S52-409	498	56 2/3
9	S52-503	350	120 2/3
10	S52-504	350	120 2/3
11	S52-508	418	120 2/3
12	S52-907	428	348 2/3
13	S52-9904	1944	493 1/3

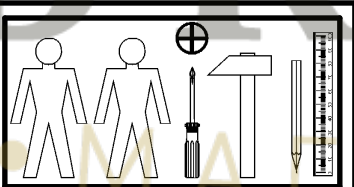

2x 160 mm c128	16x φ5x17 mm d1	4x φ7x50 mm e1	12x φ6x13 mm e3	16x φ8x30 mm f1	8x φ6.5x40 mm f25	4x k1	55x l1	2x l37
4x φ4x30 mm p9	8x φ3x12 mm p54	10x φ1.5x12mm #16 r1	8x φ1.2x10.5mm #12 r15	18x r16	4x s1	4x φ16 s2	2x 350 mm w45\CL	2x 350 mm w45\CR
2x 350 mm w45\DL	2x 350 mm w45\DR	1x z1	1x n26\1	1x φ3.5x16 mm p38				

1 

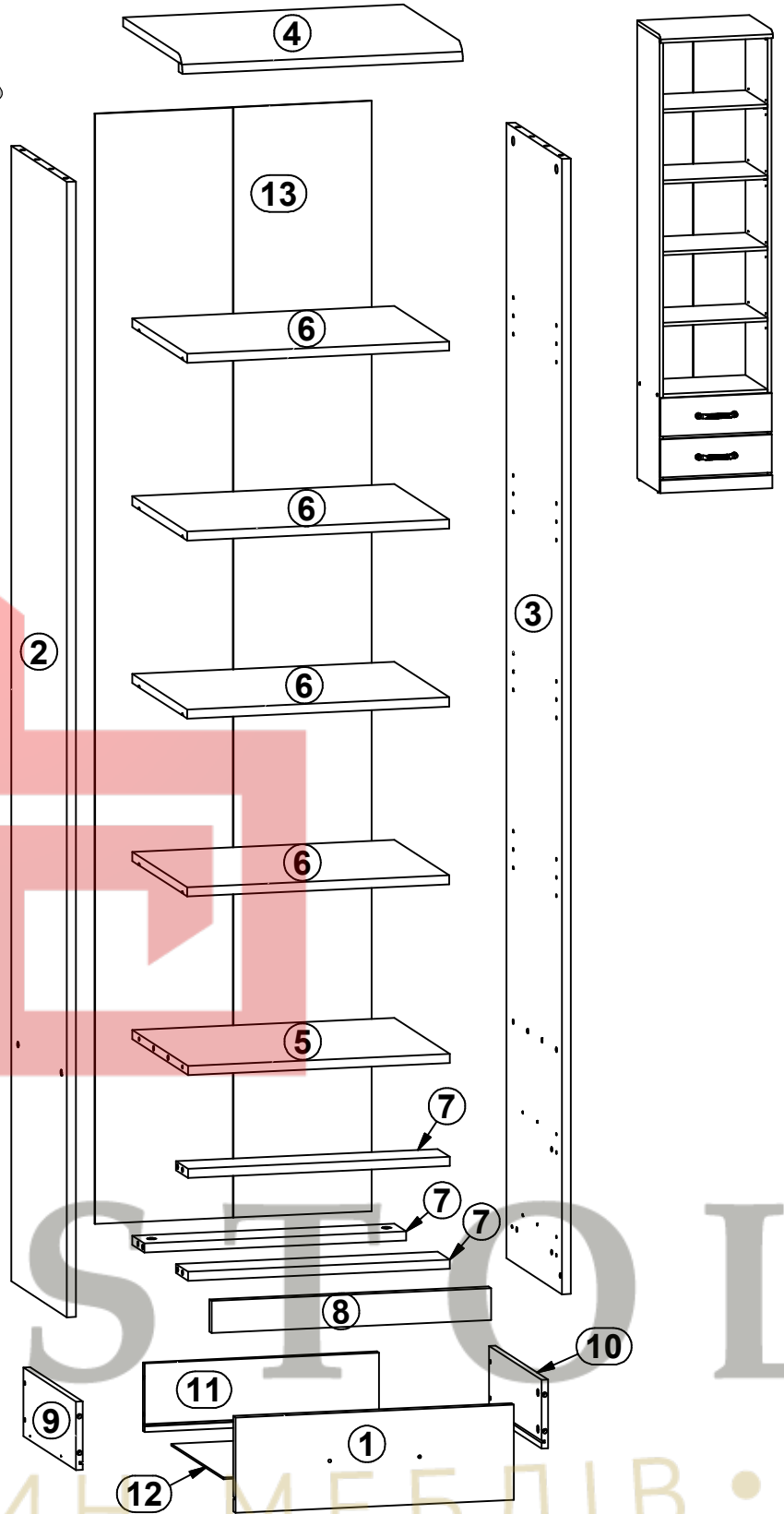
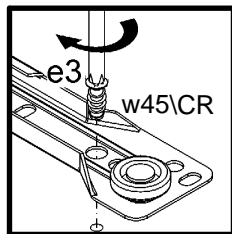
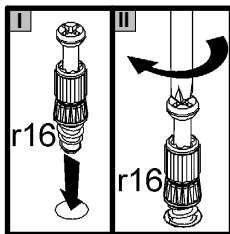
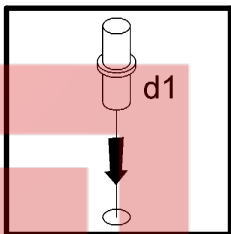
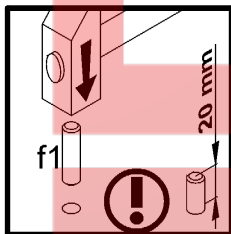
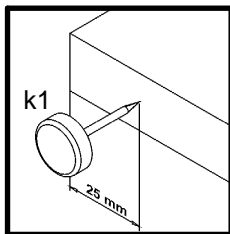
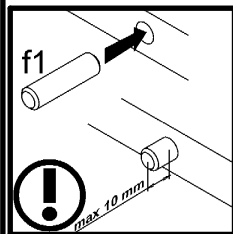
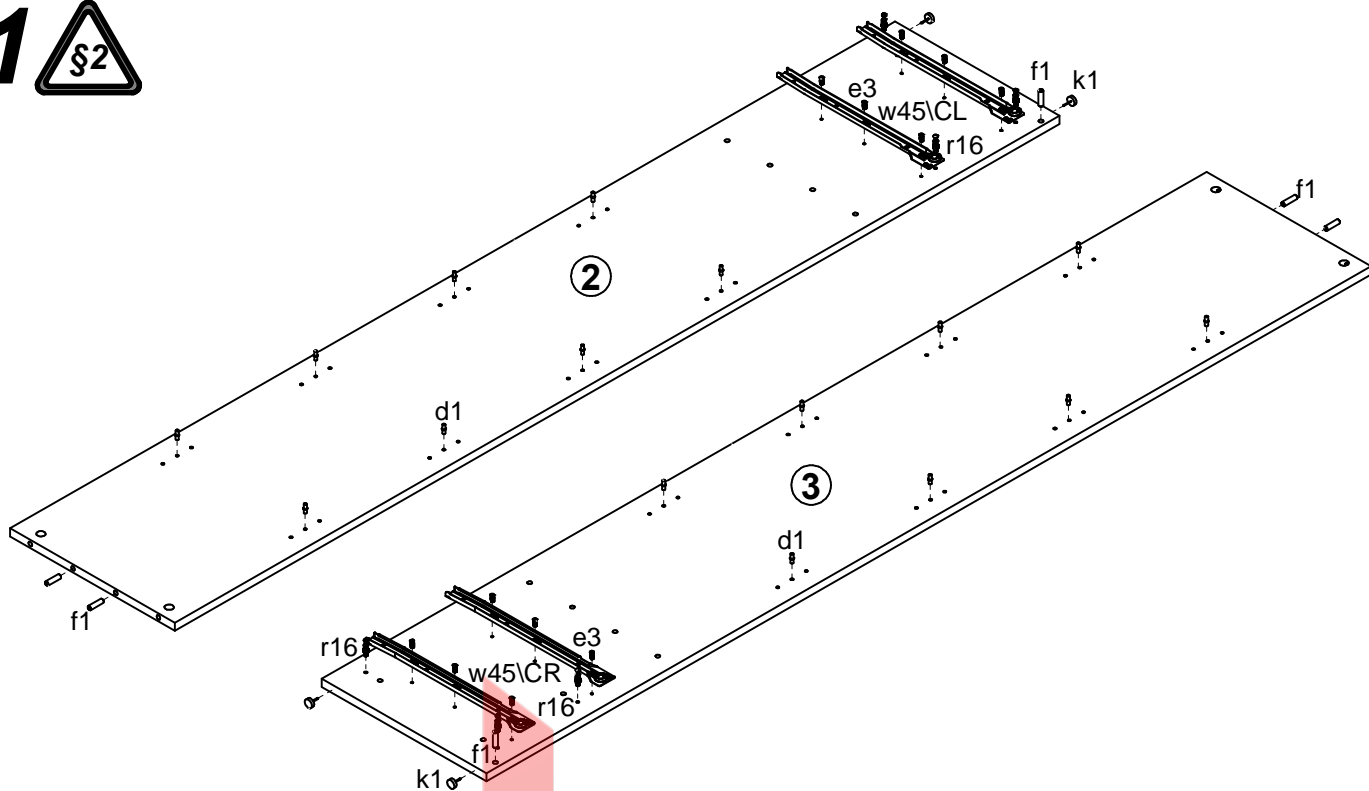

2 

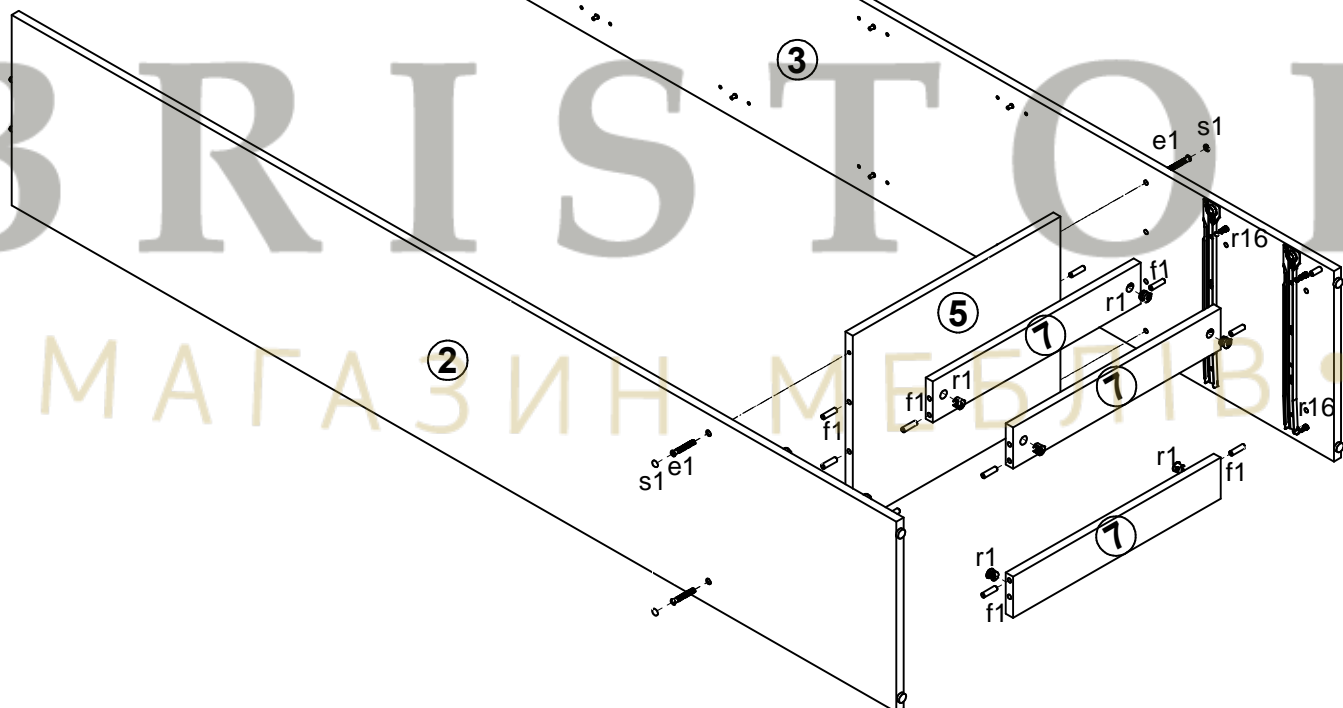
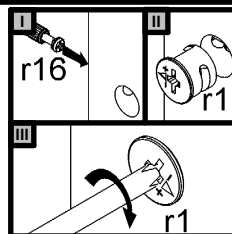
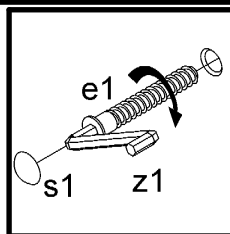
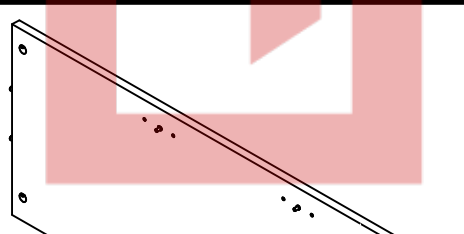
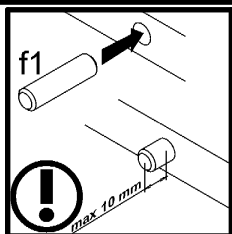

3

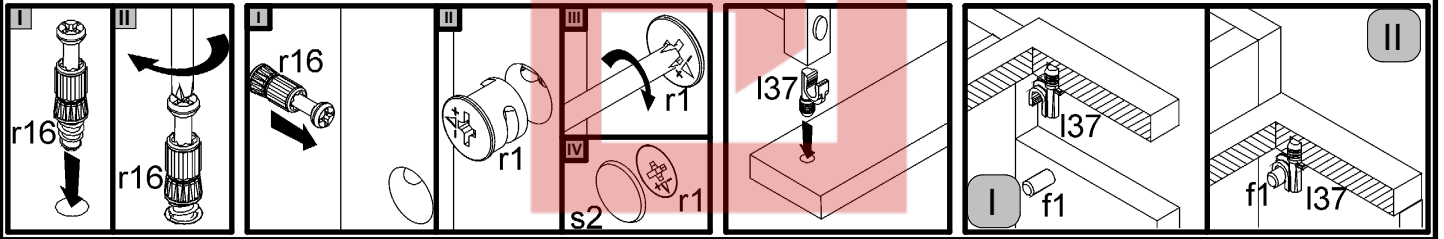
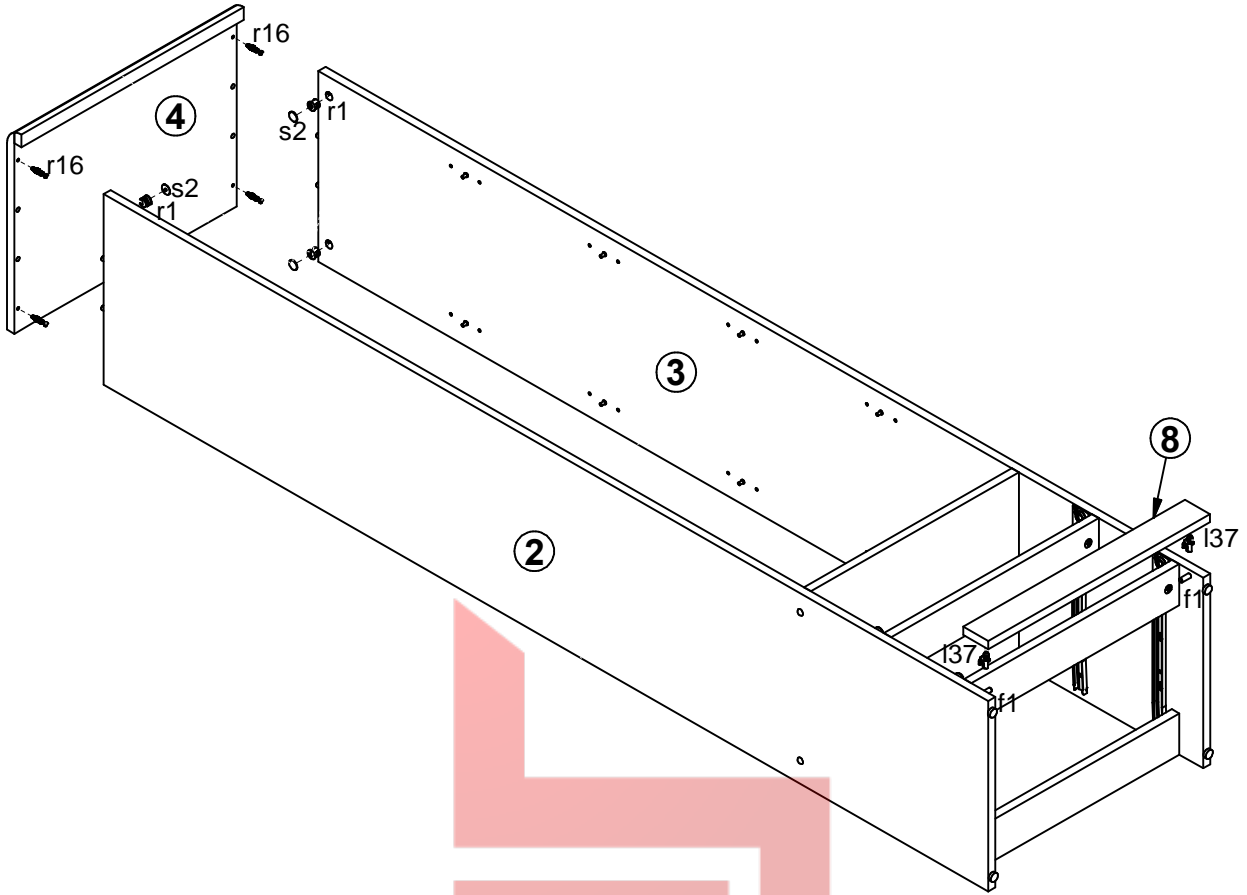

4

