

A	B	C	D
1	SM1-107	343	475 1/2
2	SM1-106	343	475 1/2
3	SM1-201	900	500 1/2
4	SM1-202	900	475 1/2
5	SM1-401	383	90 1/2
6	SM1-502	400	280 1/2
7	SM1-503	400	280 1/2

A	B	C	D
8	SM1-504	810	280 1/2
9	SM1-505	899	482 1/2
10	SM1-906	825	399 1/2
11	SM1-905	370	895 1/2
12	SM1-007	895	354 2/2
13	SM1-402	900	100 2/2

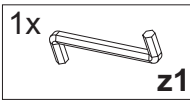

1 

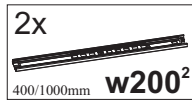
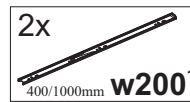
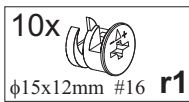
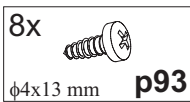
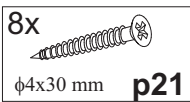
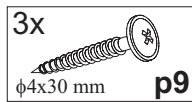
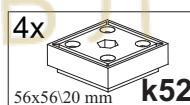
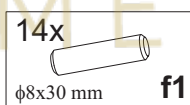
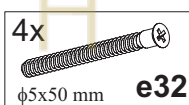
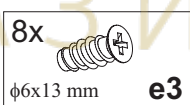
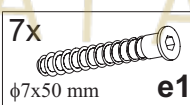
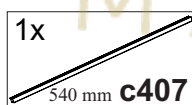
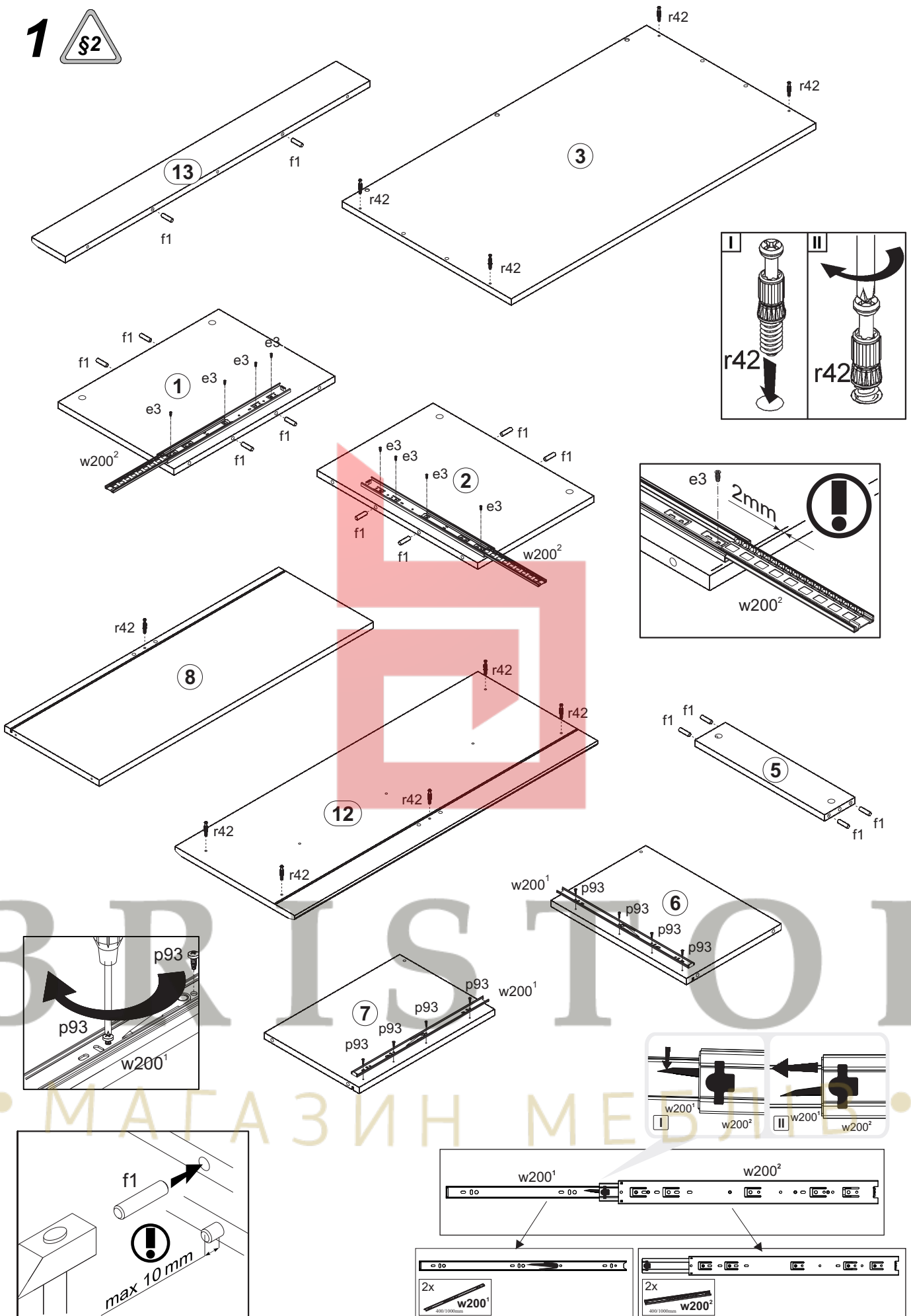

2

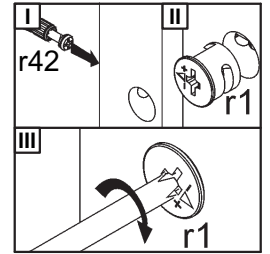
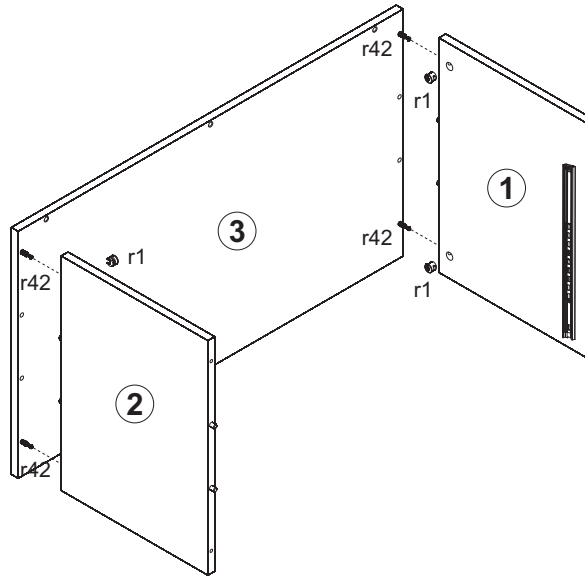

3

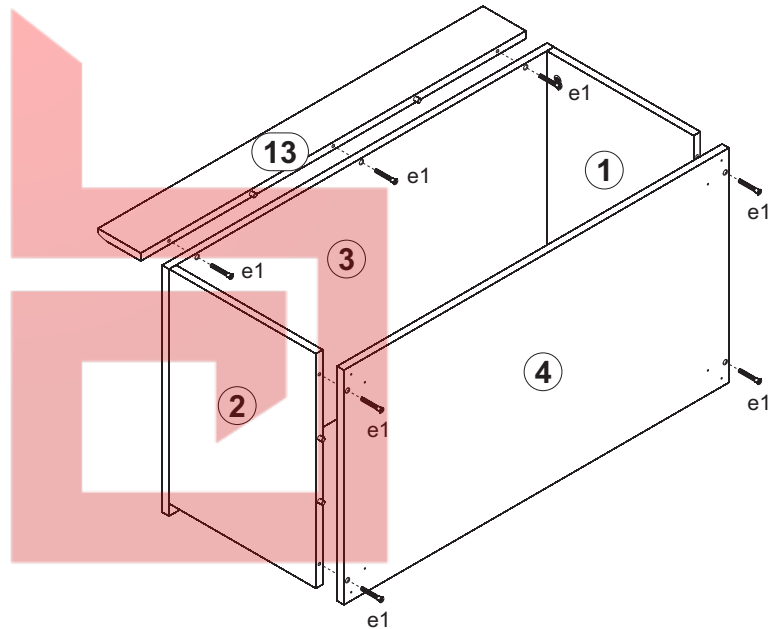
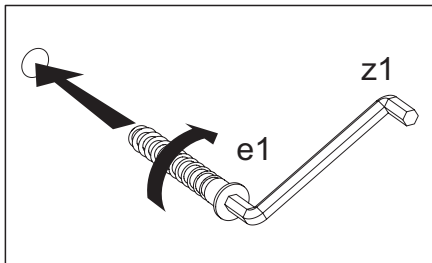

4

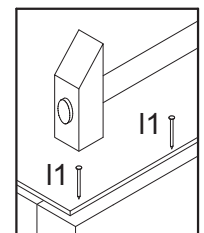
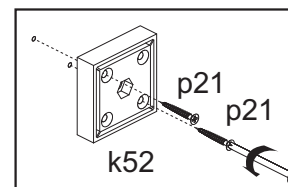
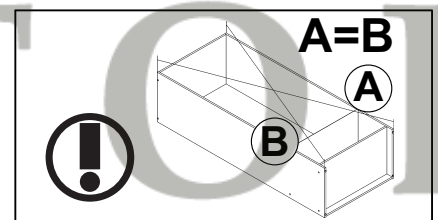
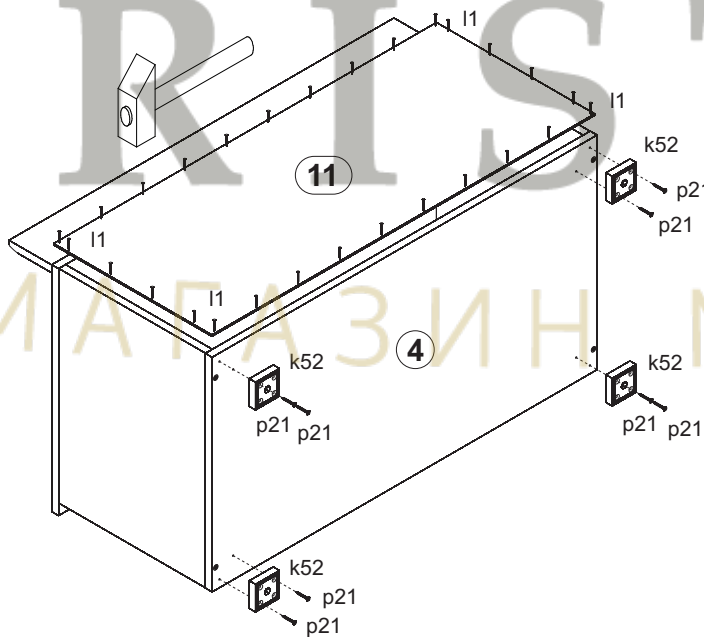

5

