

A	B	C		D
1	S322-0003	794	240	4/4
2	S322-0004	1616	396	3/4
3	S322-1103	1968	540	1/4
4	S322-1104	1968	540	1/4
5	S322-2202	884	551	2/4
6	S322-3301	800	537	2/4
7	S322-4402	800	80	2/4
8	S322-4403	800	80	2/4
9	S322-9904	772	505	2/4
10	S322-9905	1925	413	1/4
11	ZB-5510	743	200	2/4
12	BB-505	500	200	2/4
13	BB-506	500	200	2/4
14	dr-792	792	22	2/4
15	S322-9905	1885	14	1/4

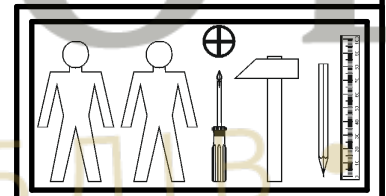

8x K16 a43	8x b19	3x M4 c415	4x d4 Ø6,3x15 mm	6x e3 Ø6x13 mm	6x e19 Ø5x9 mm	14x f1 Ø8x30 mm	4x f25 Ø6,5x40 mm	3x j1 M4x20 mm
4x k1	65x l1	2x h=22mm n1	1x n26	2x p1 Ø3,5x13 mm	1x p25 Ø3,5x16 mm	1x p35 Ø3,5x10 mm	7x p38 Ø3,5x16 mm	16x p51 Ø3,5x15 mm
20x Ø15x12 mm #16 r1	20x 20/11 r42	6x s2 Ø16	1x 500 mm t34	1x 500 mm w26\CL	1x 500 mm w26\CR	1x 500 mm w26\DL	1x 500 mm w26\DR	

# 1

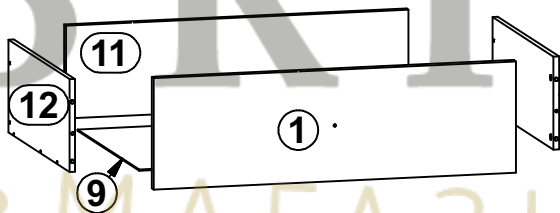
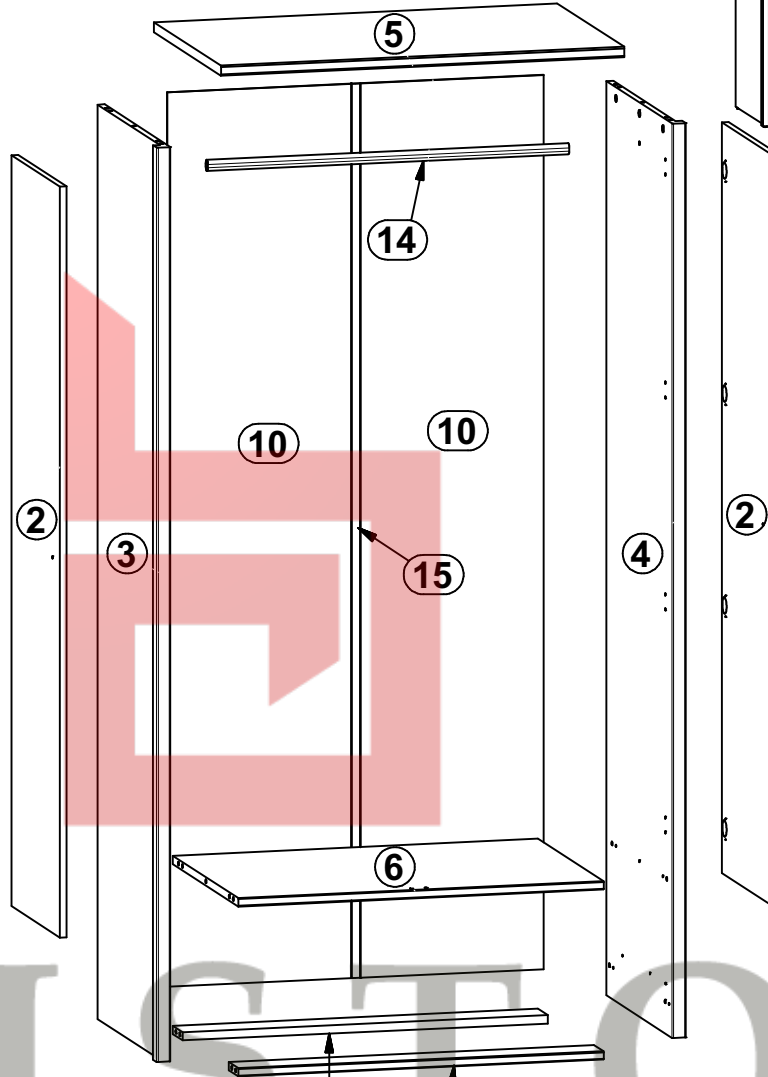
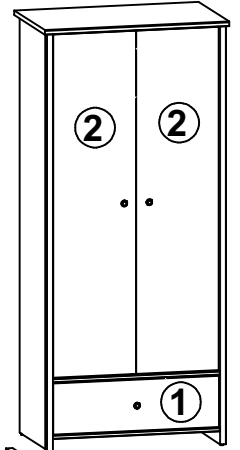
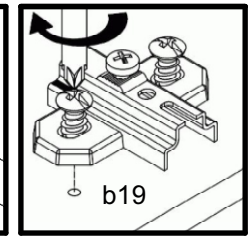
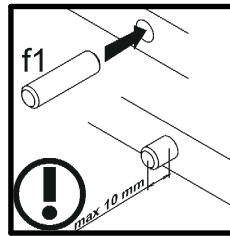
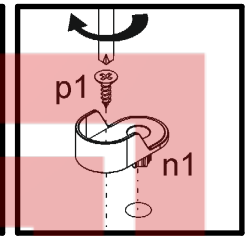
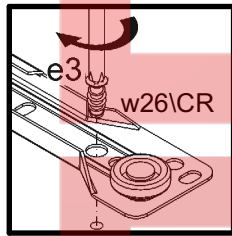
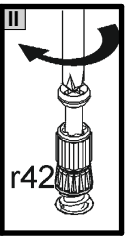
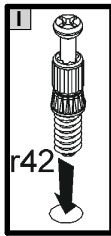
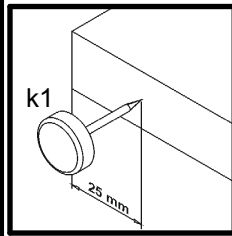
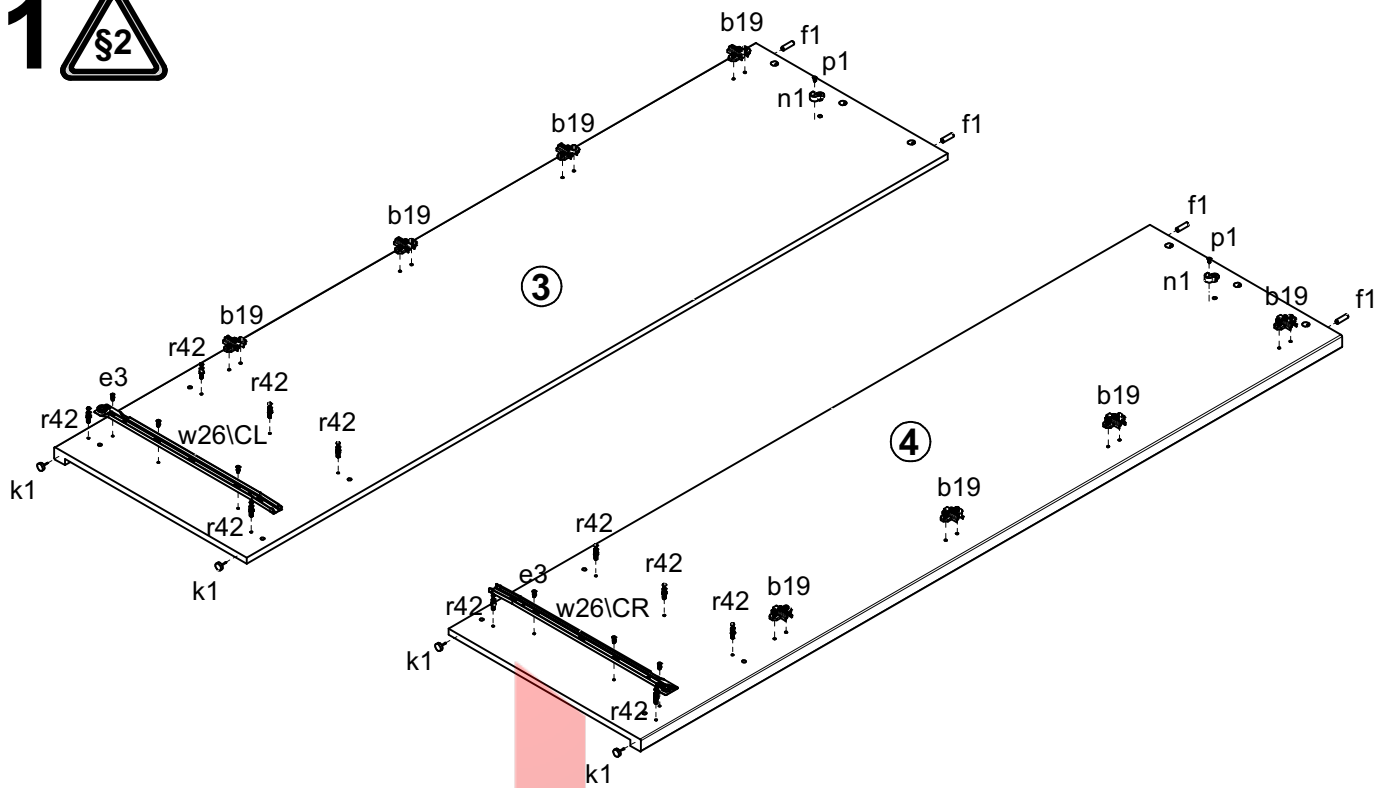

# 2

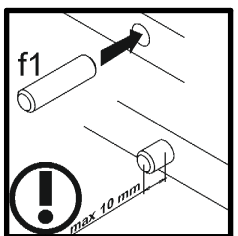
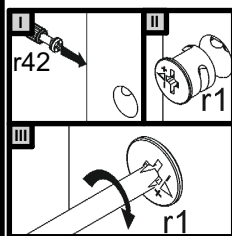
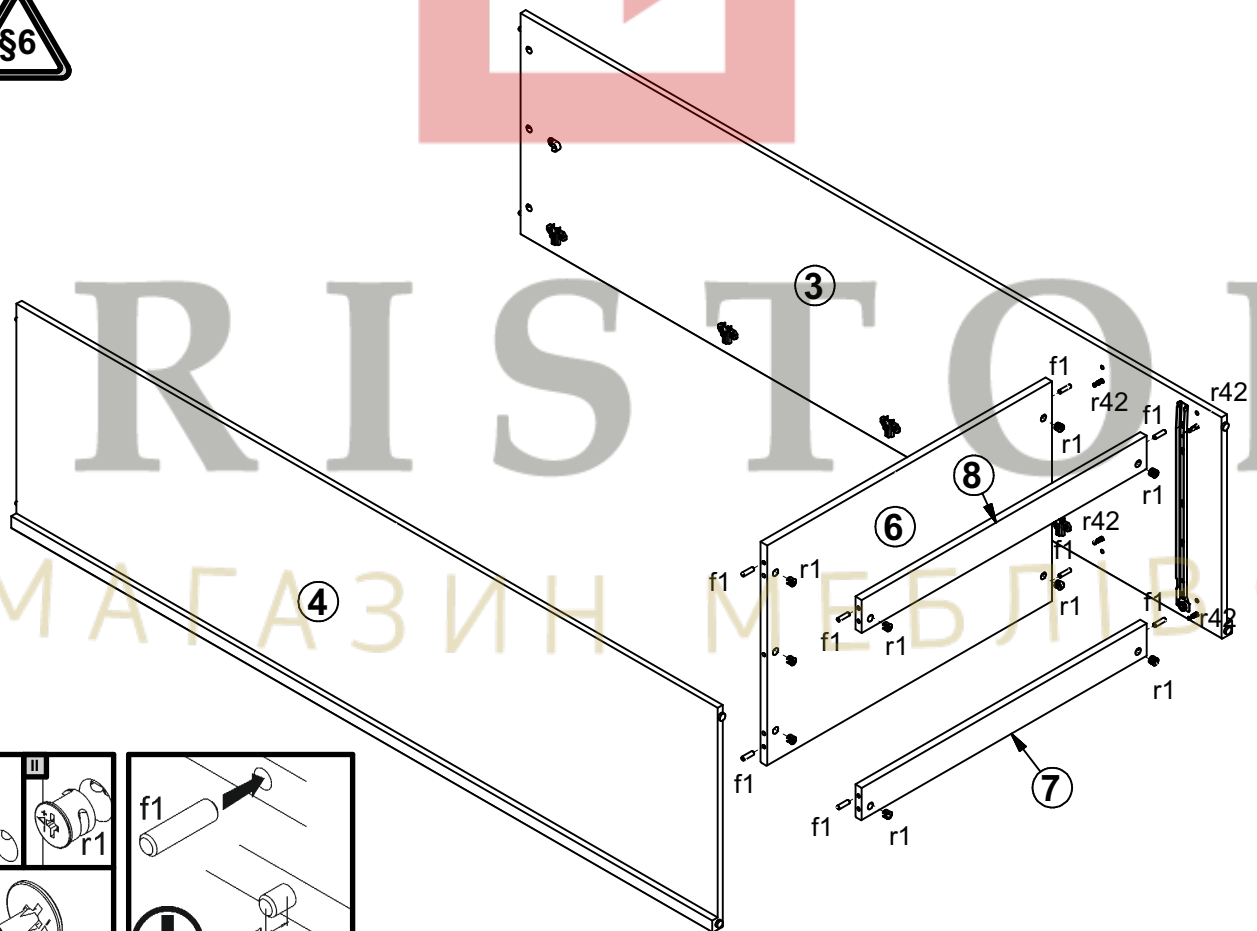

# 3

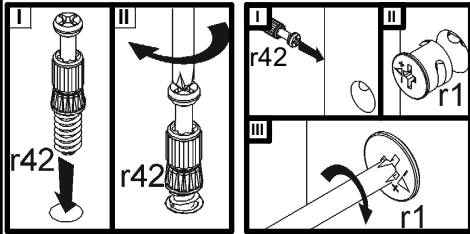
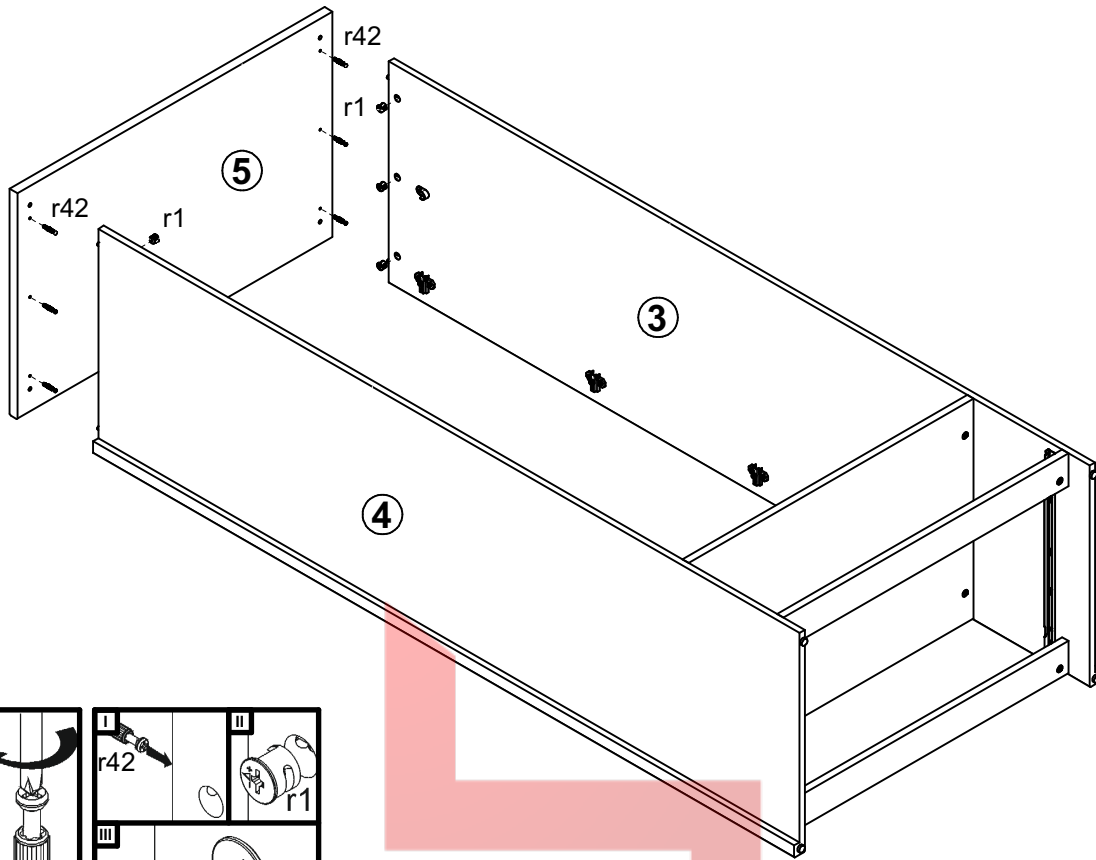

# 4

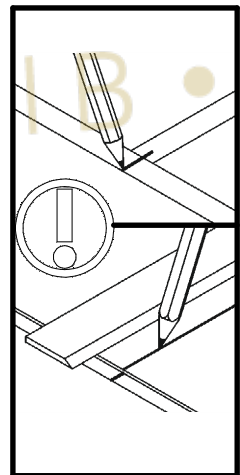
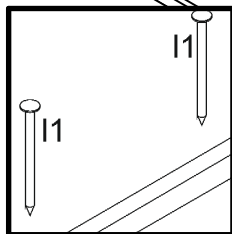
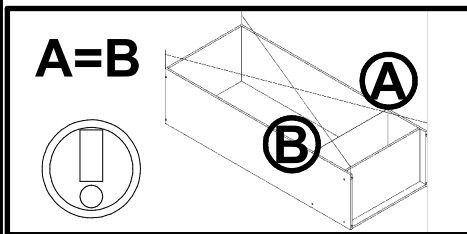
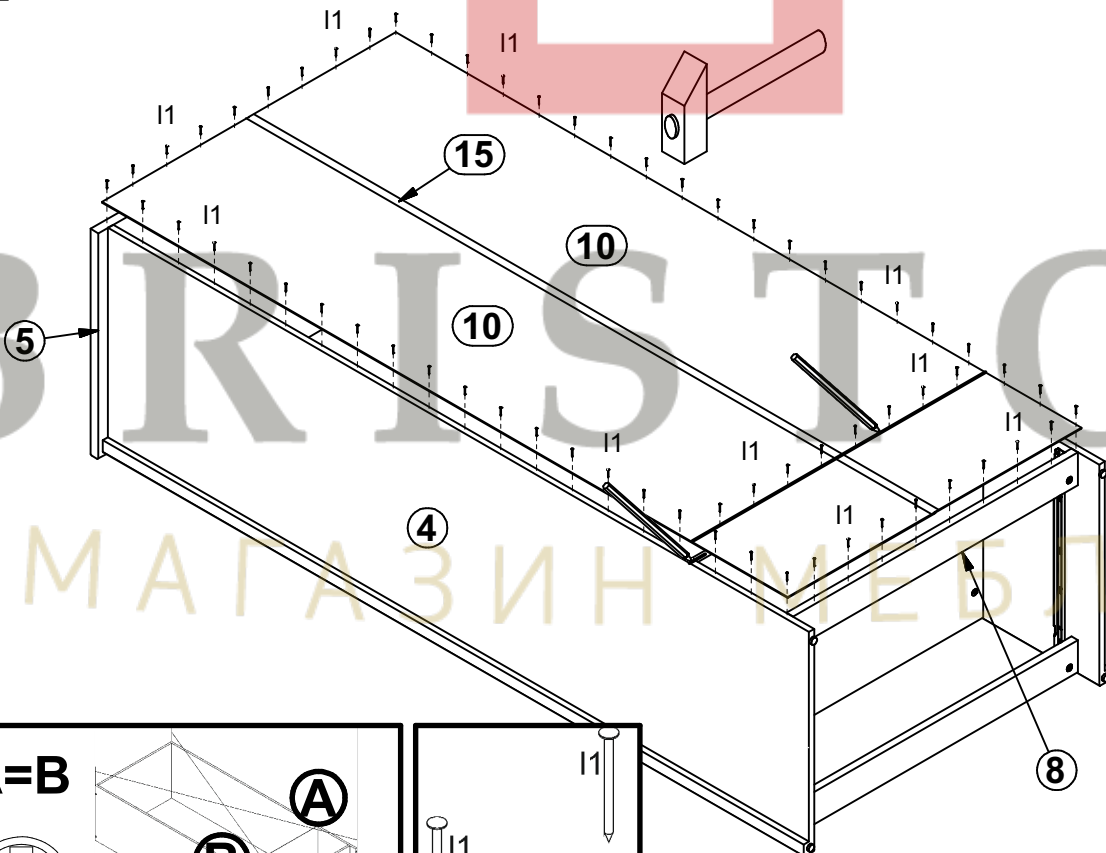

# 5

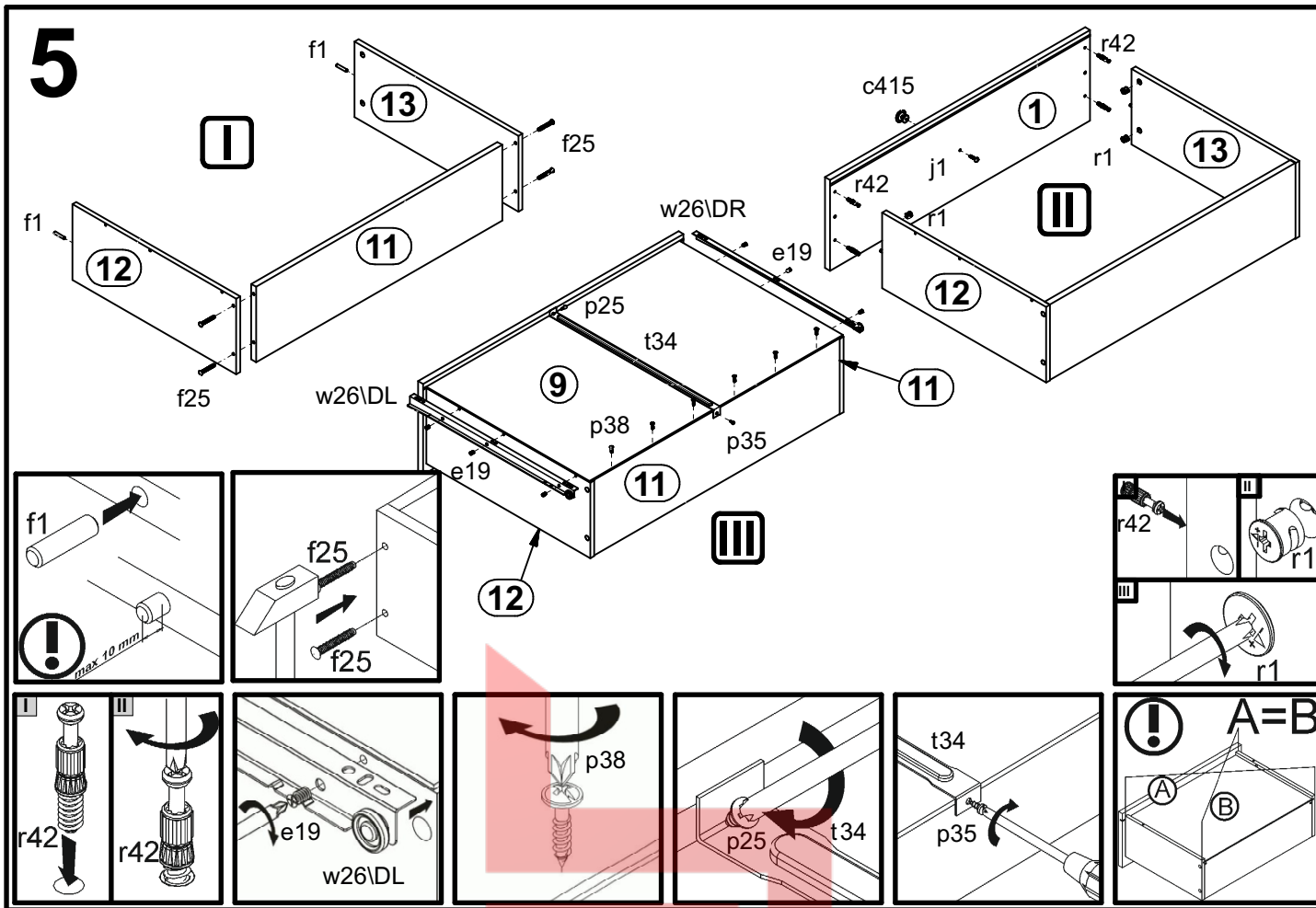

# 6

