

**A**

# PORTO

**S322-SZF3D2S**

A	B	C	D	A	B	C	D
1	S322-0014	595	240	3/4	11	S322-3310	1199 537
2	S322-0015	595	240	3/4	12	S322-3311	396 512
3	S322-0016	1616	396	4/4	13	S322-9917	564 505
4	S322-0017	1616	396	4/4	14	S322-9919	1925 403
5	S322-1116	1968	540	1/4	15	S322-9920	1925 417
6	S322-1117	1968	540	1/4	16	ZB-5511	534 200
7	S322-1118	248	516	1/4	17	BB-505	500 200
8	S322-1119	1624	518	1/4	18	BB-506	500 200
9	S322-2206	1283	551	2/4	19	dr-782	782 22
10	S322-3309	1199	537	2/4	20	Lh-1885	1885 14

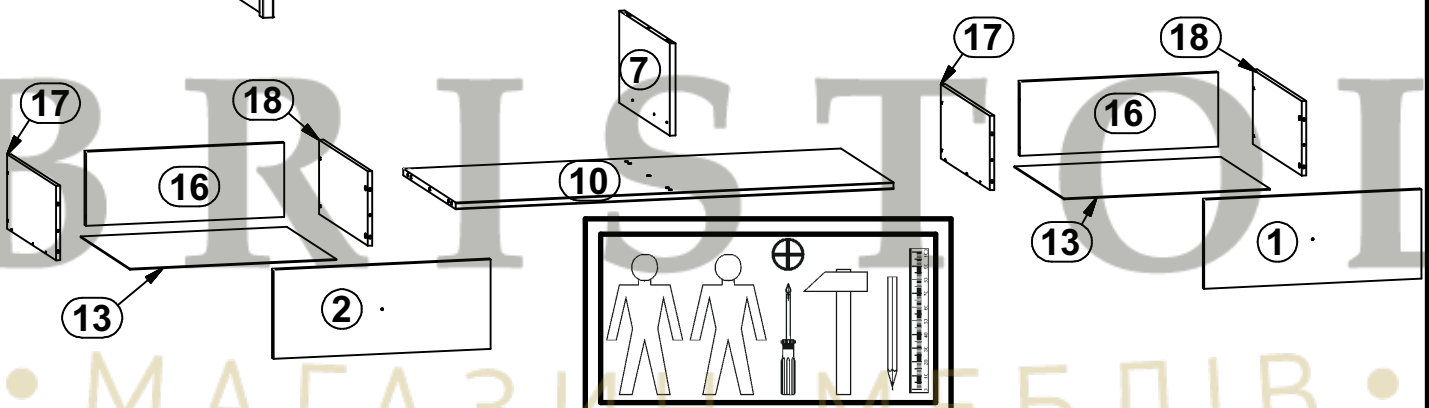
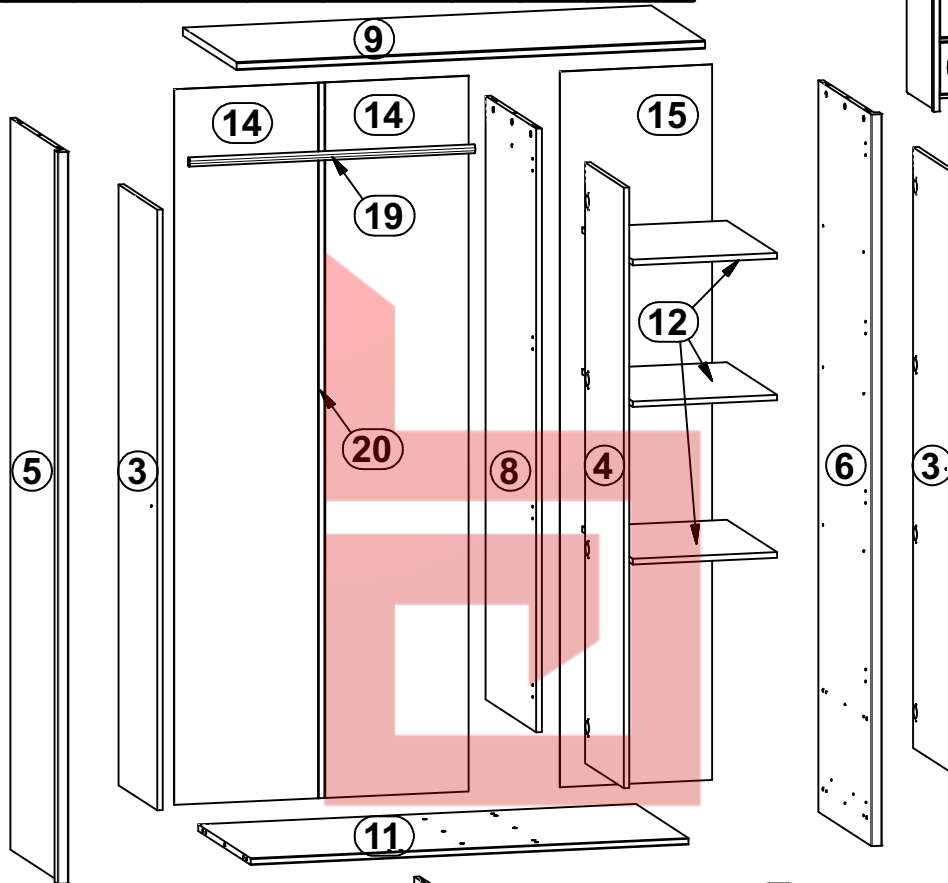
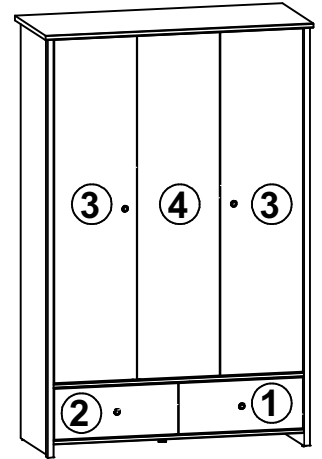

8x K16 a43	4x K1 a44	12x D9 b19	4x M4 c415	12x d1 Ø5x17 mm	4x d4 Ø6,3x15 mm	9x e1 Ø7x50 mm	1x e2 Ø6,3x13 mm	9x e3 Ø6x13 mm
12x e19 Ø5x9 mm	24x f1 Ø6x30 mm	8x f25 Ø6,5x40 mm	4x j1 M4x20 mm	4x k1	1x k3813 42,5x42,5x4 mm	1x k388 30x30x60 mm	120x l1	2x n1 h=22mm
2x o21 silikon	2x p1 Ø3,5x13 mm	12x p38 Ø3,5x16 mm	24x p51 Ø3,5x15 mm	3x p54 Ø3x12 mm	29x r1 Ø15x12 mm #16	29x r42 20/11	2x w26\CL 500 mm	2x w26\CR 500 mm
2x w26\DL 500 mm	2x w26\DR 500 mm	3x s1	9x s2 Ø16	1x z1				

1 

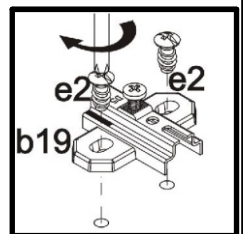
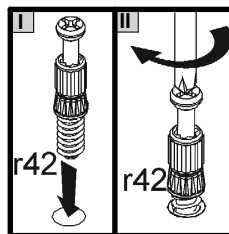
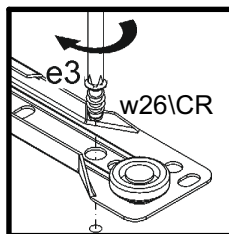
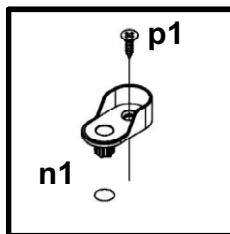
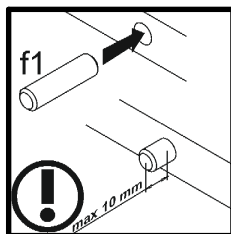
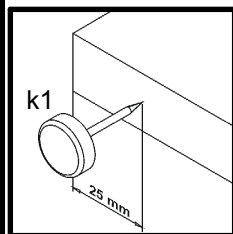
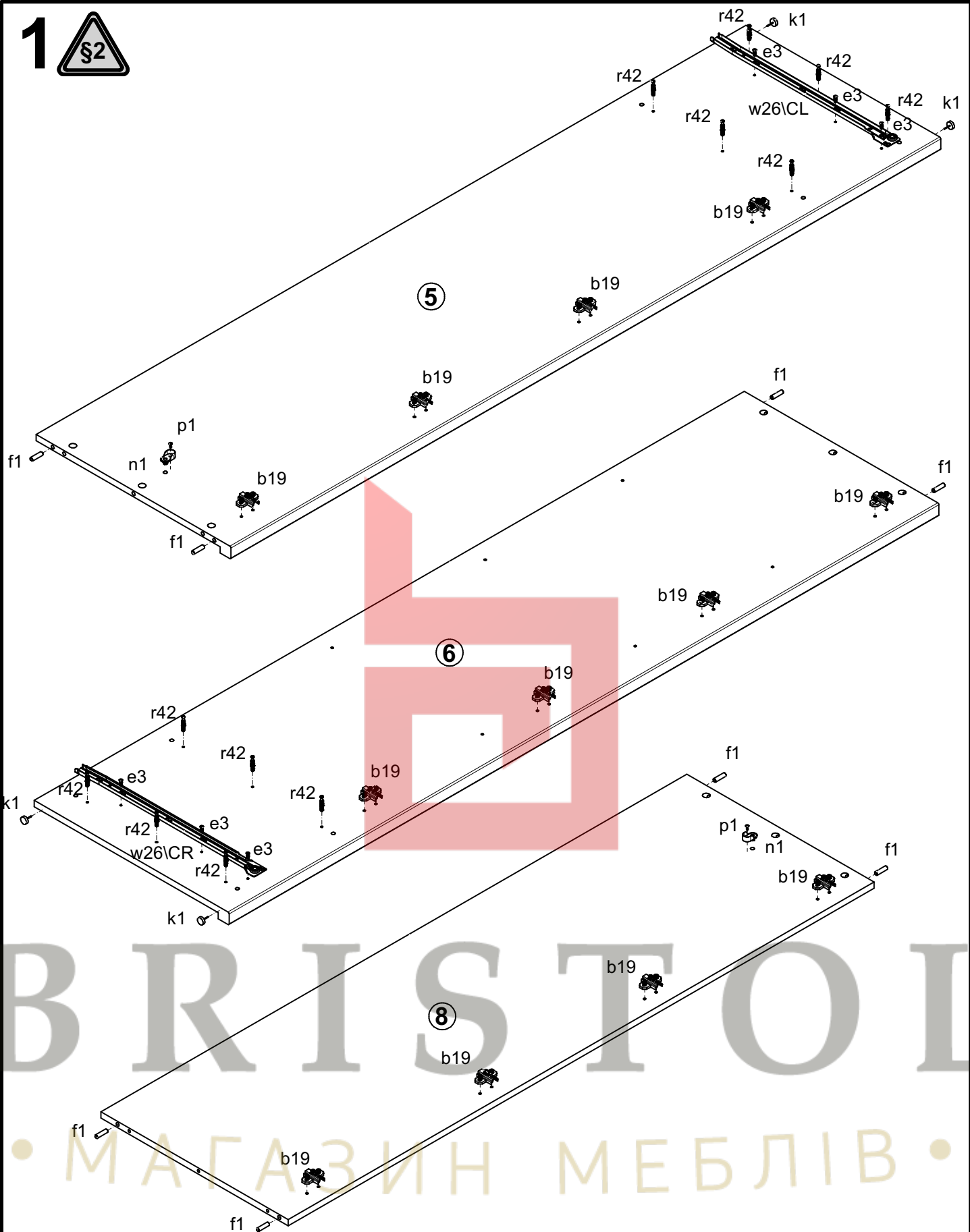

# 2

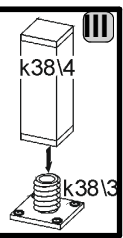
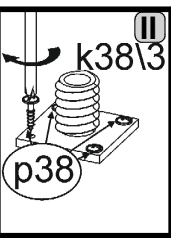
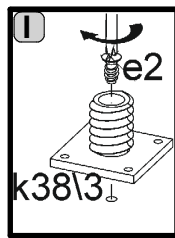
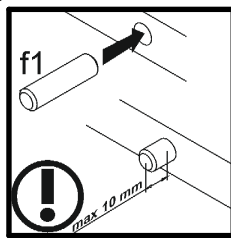
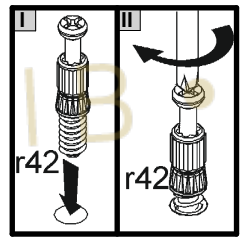
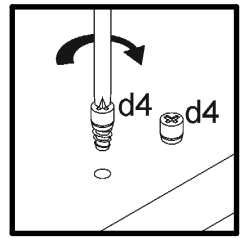
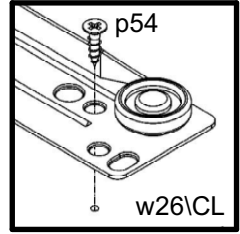
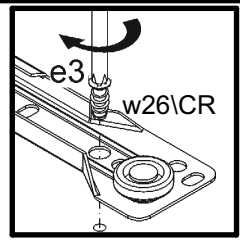
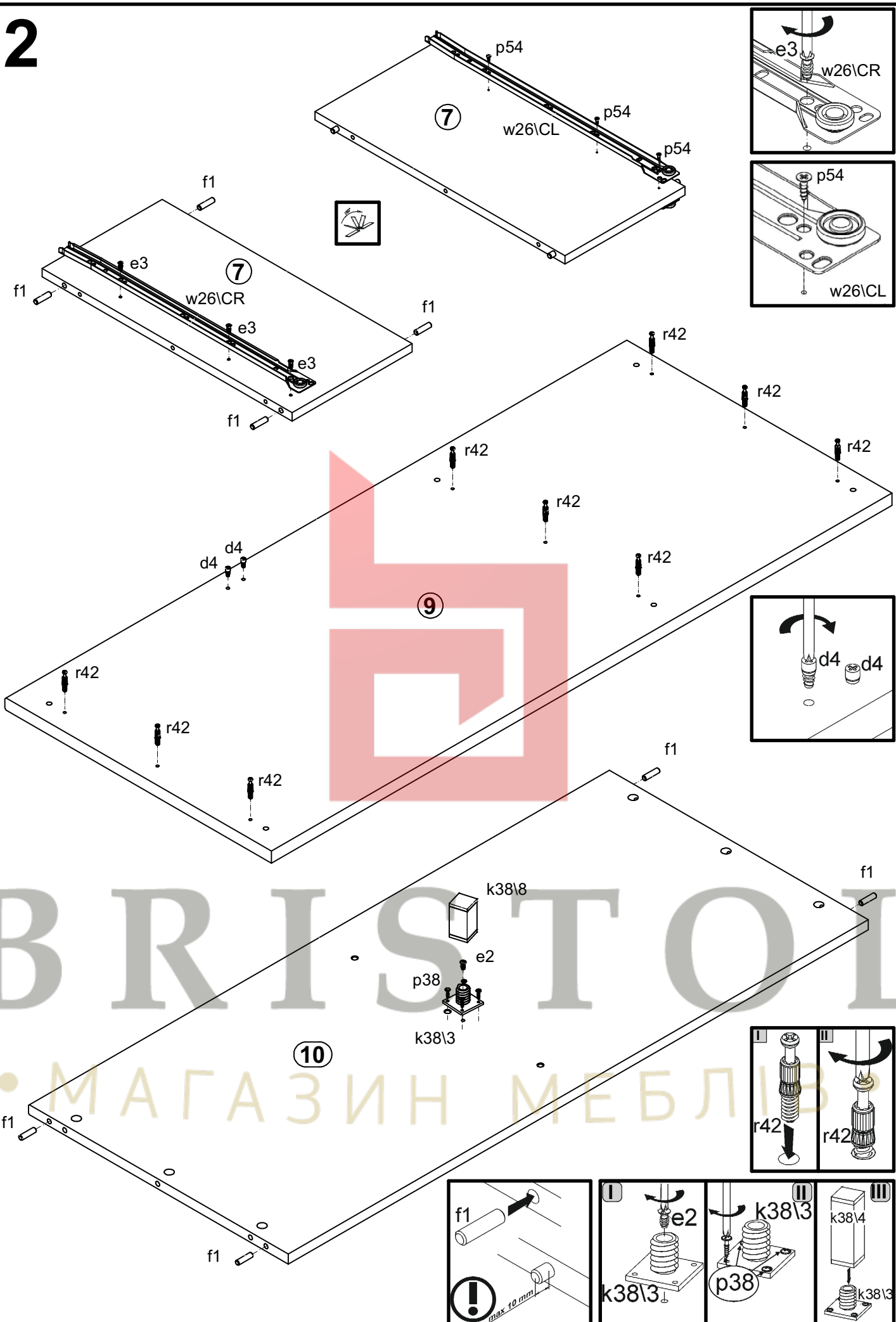

# 3

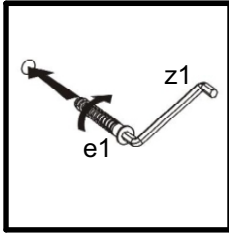
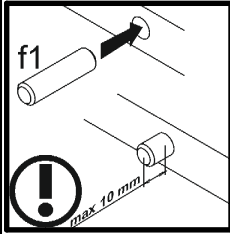
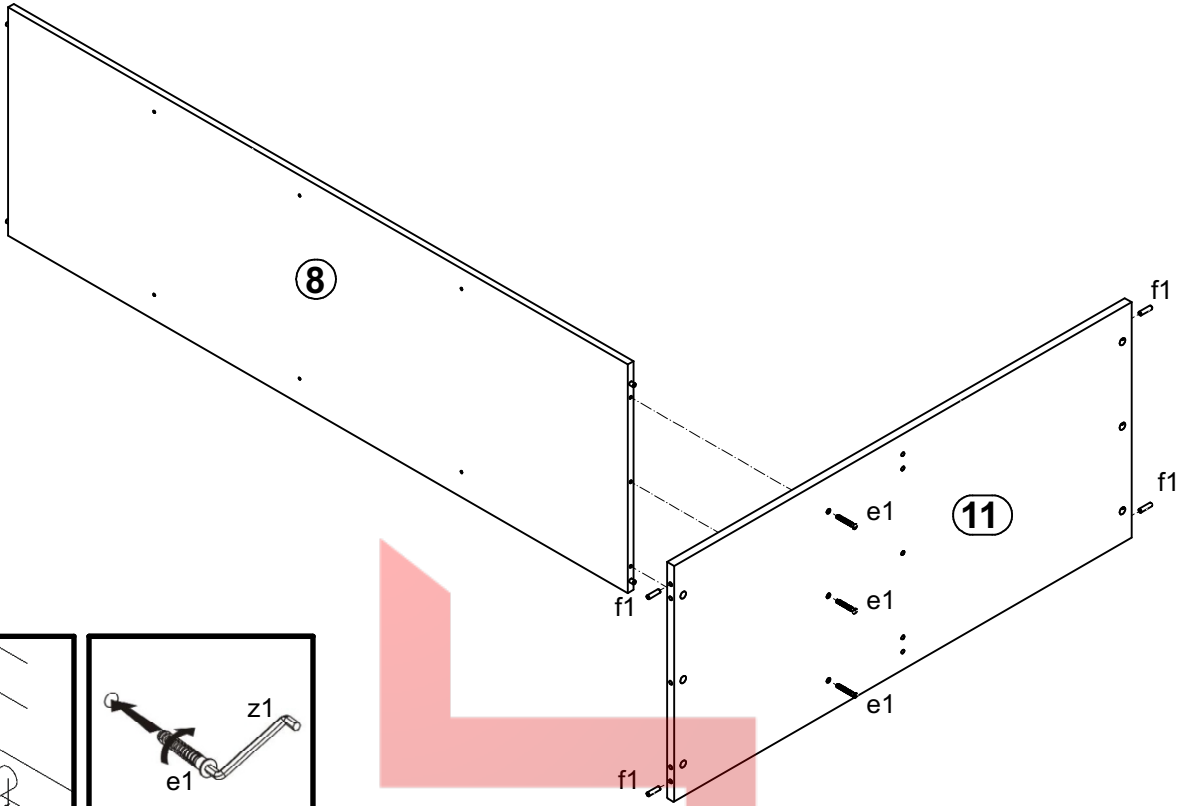

# 4

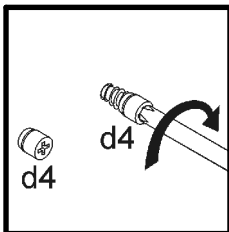
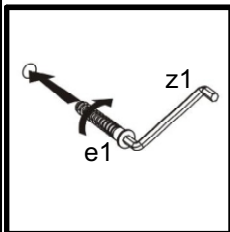
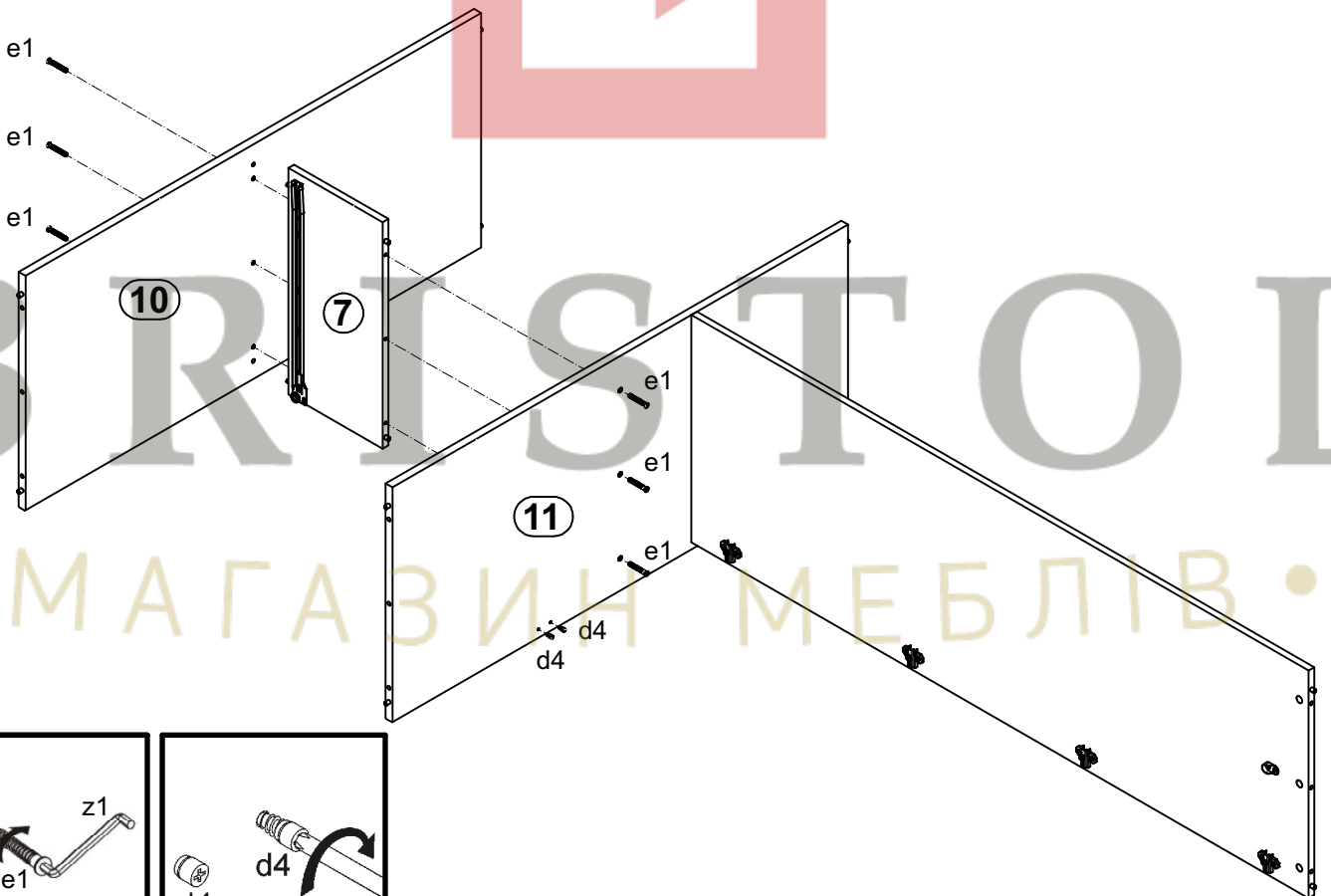

# 5

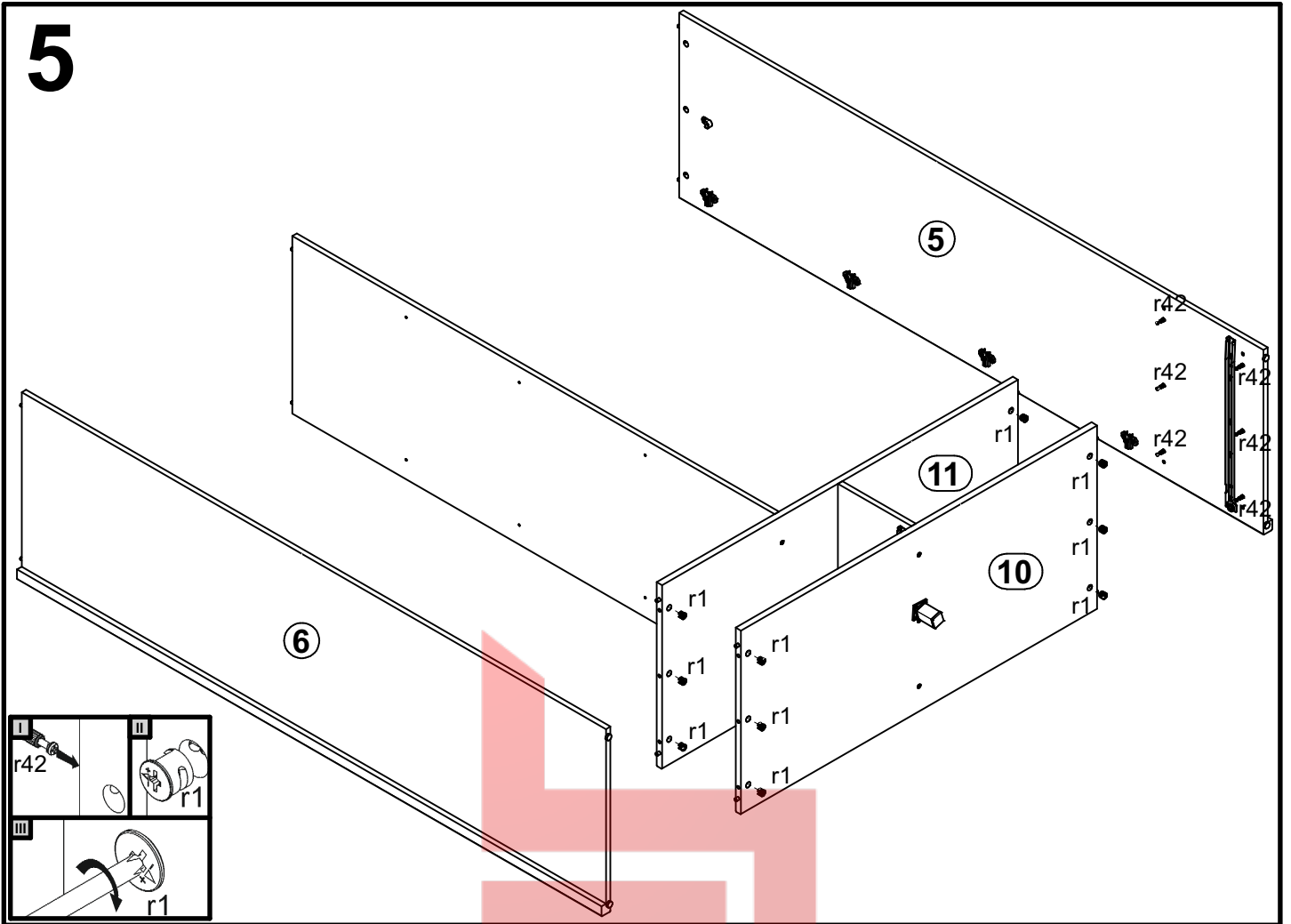

# 6

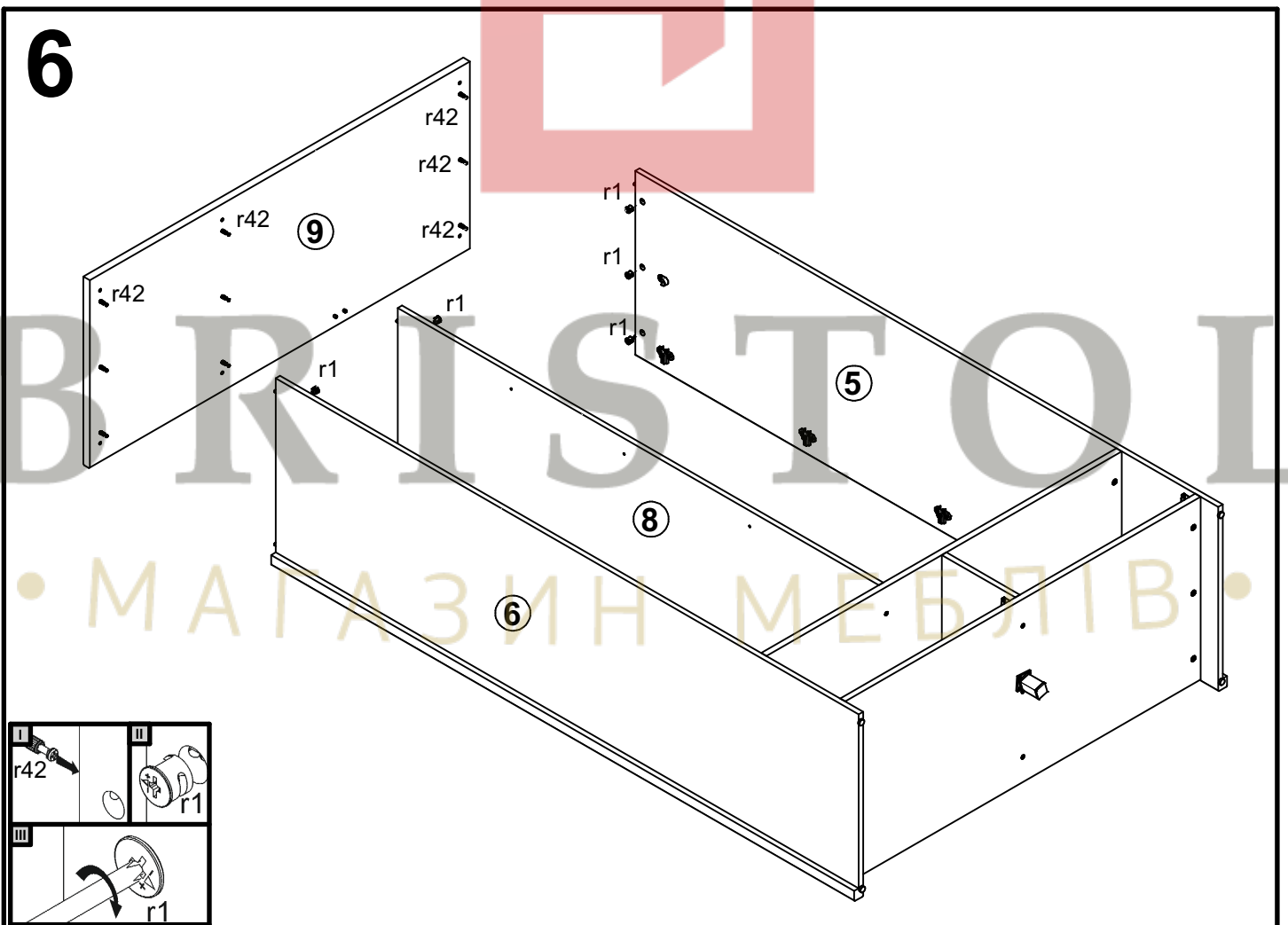

# 7

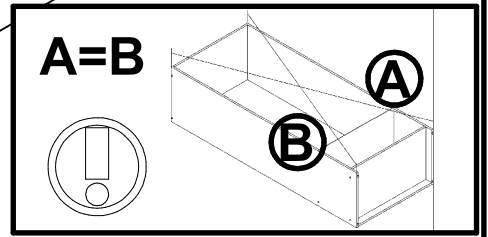
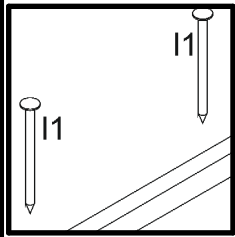
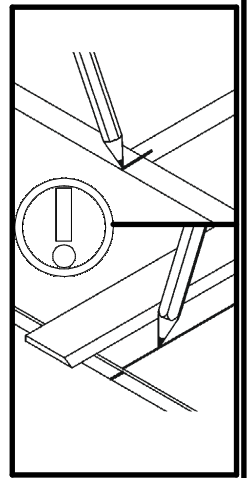
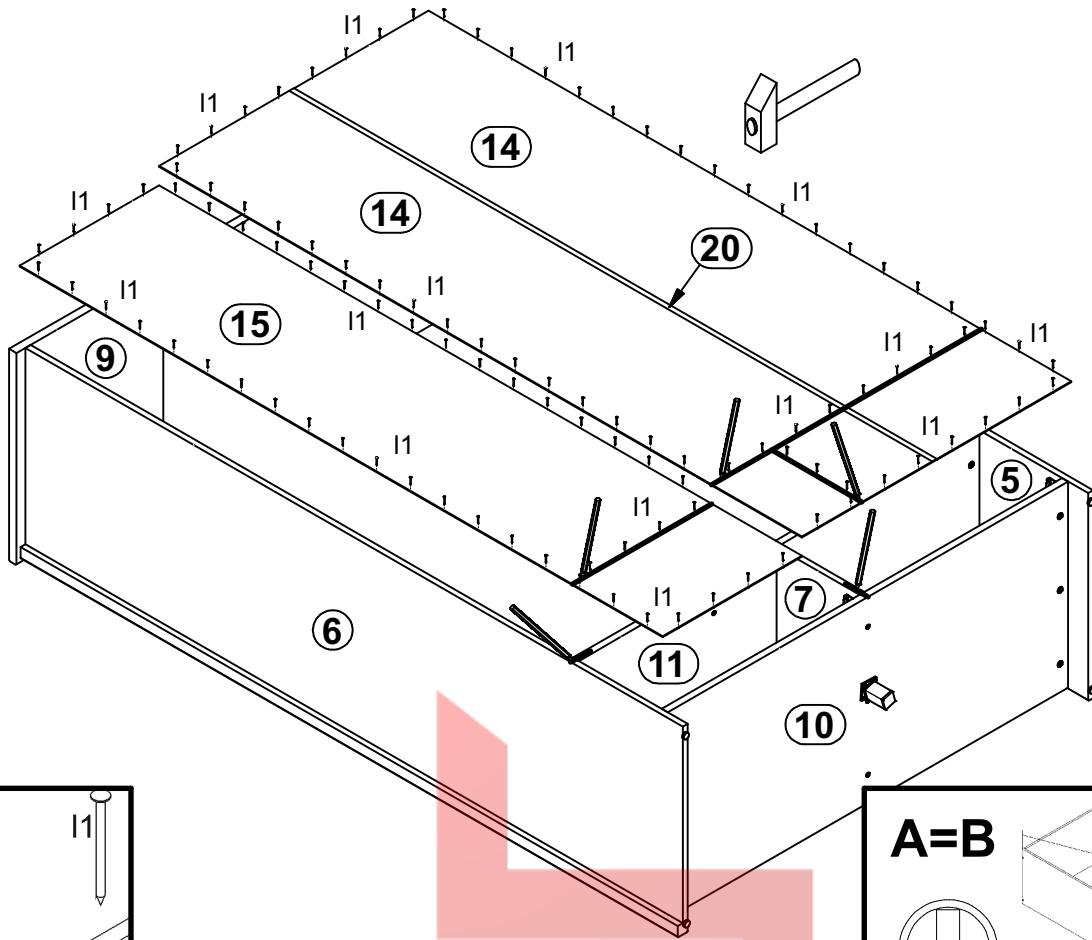

# 8

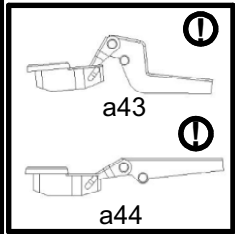
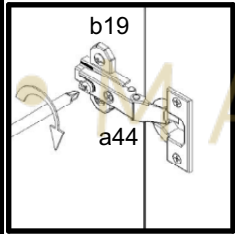
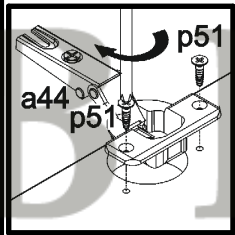
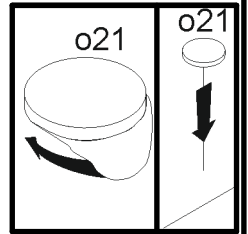
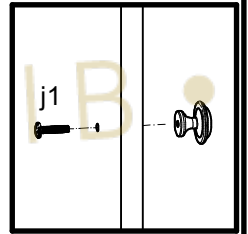
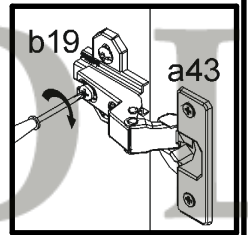
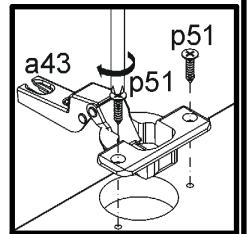
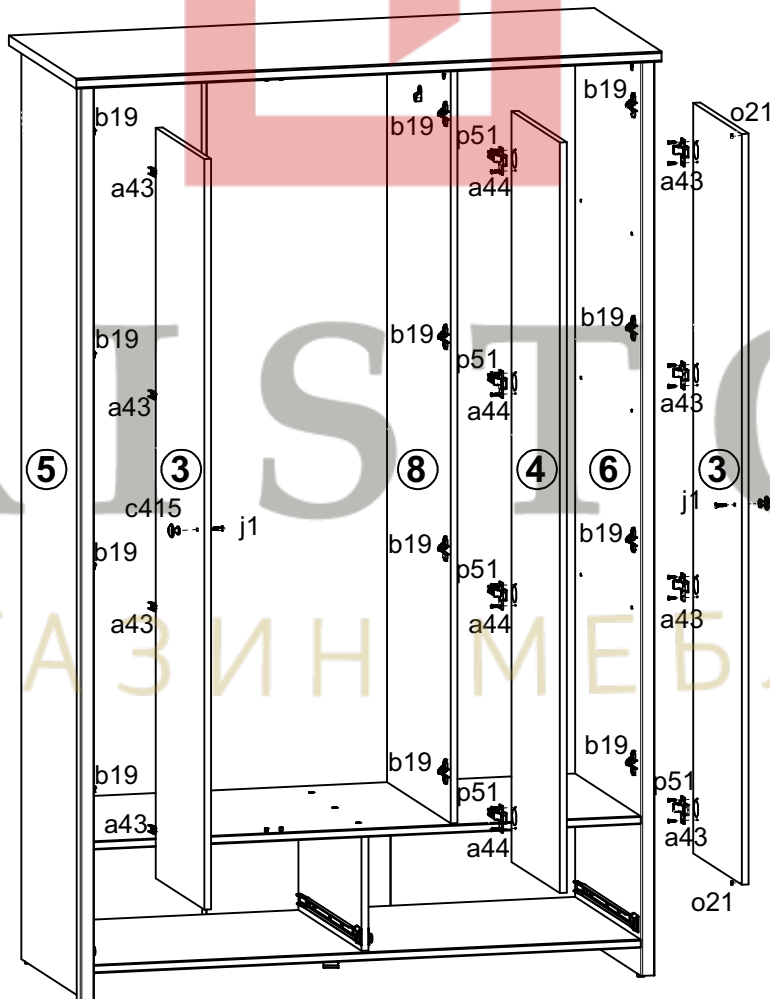

# 9

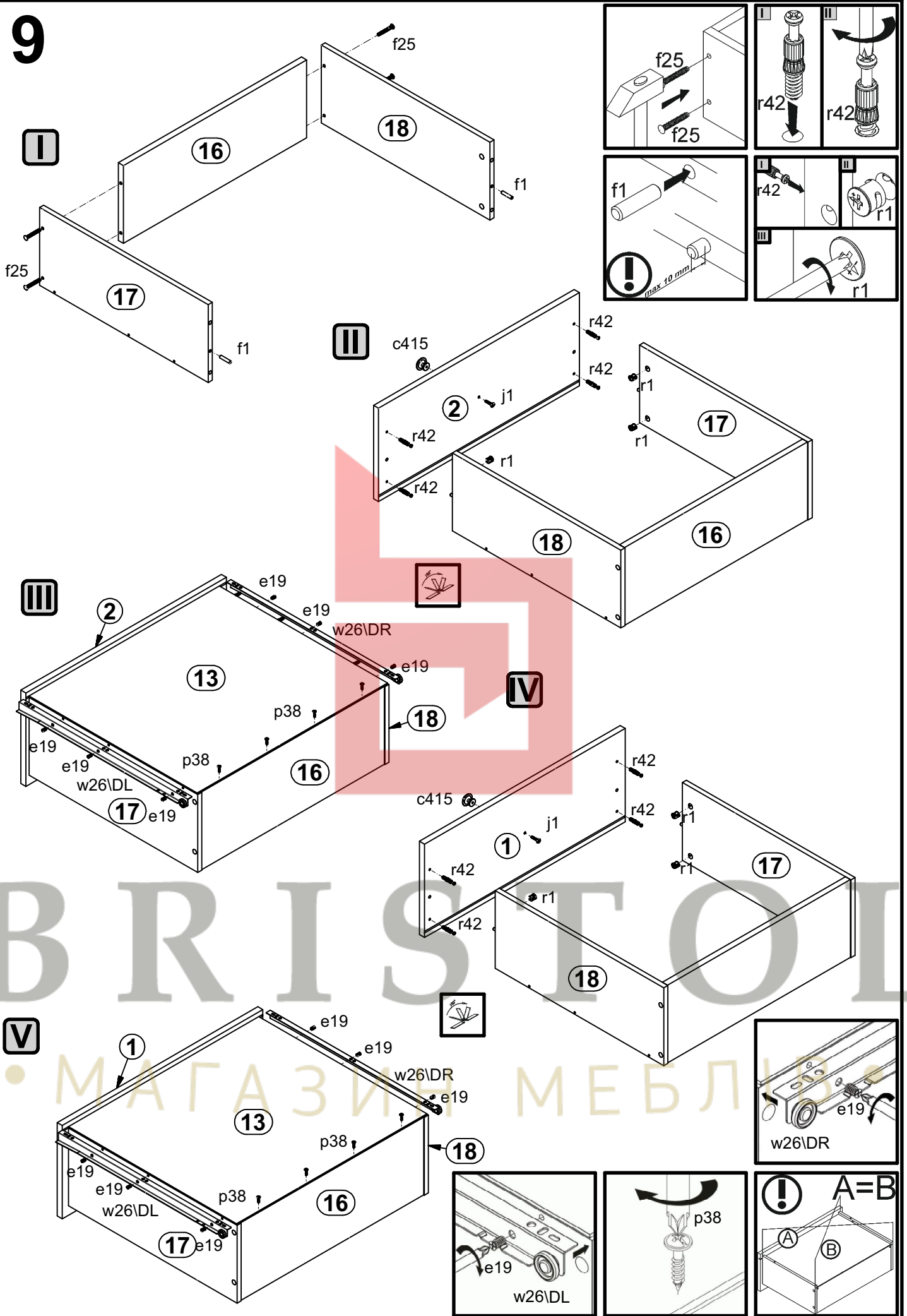

# 10

