

A	B	C		D	A	B	C		D
1	S190-009	1550	596	6/6	11	S190-553	156	80	3/6
2	S190-016	596	196	5/6	12	S190-554	196	80	3/6
3	S190-017	596	196	5/6	13	S190-555	40	80	3/6
4	S190-111	1926	371	1/6	14	S190-908	1940	290	1/6
5	S190-112	1926	371	1/6	15	S190-909	525	333	2/6
6	S190-217	600	371	2/6	16	S190-505	350	120	2/6
7	S190-208	600	371	2/6	17	S190-506	350	120	2/6
8	S190-305	567	355	2/6	18	S190-507	510	120	2/6
9	S190-306	567	350	2/6	19	S190-508	510	120	2/6
10	S190-563	558	340	4/6	20	LH-1925	1925	14	1/6
					21	S190-927	1940	290	1/6

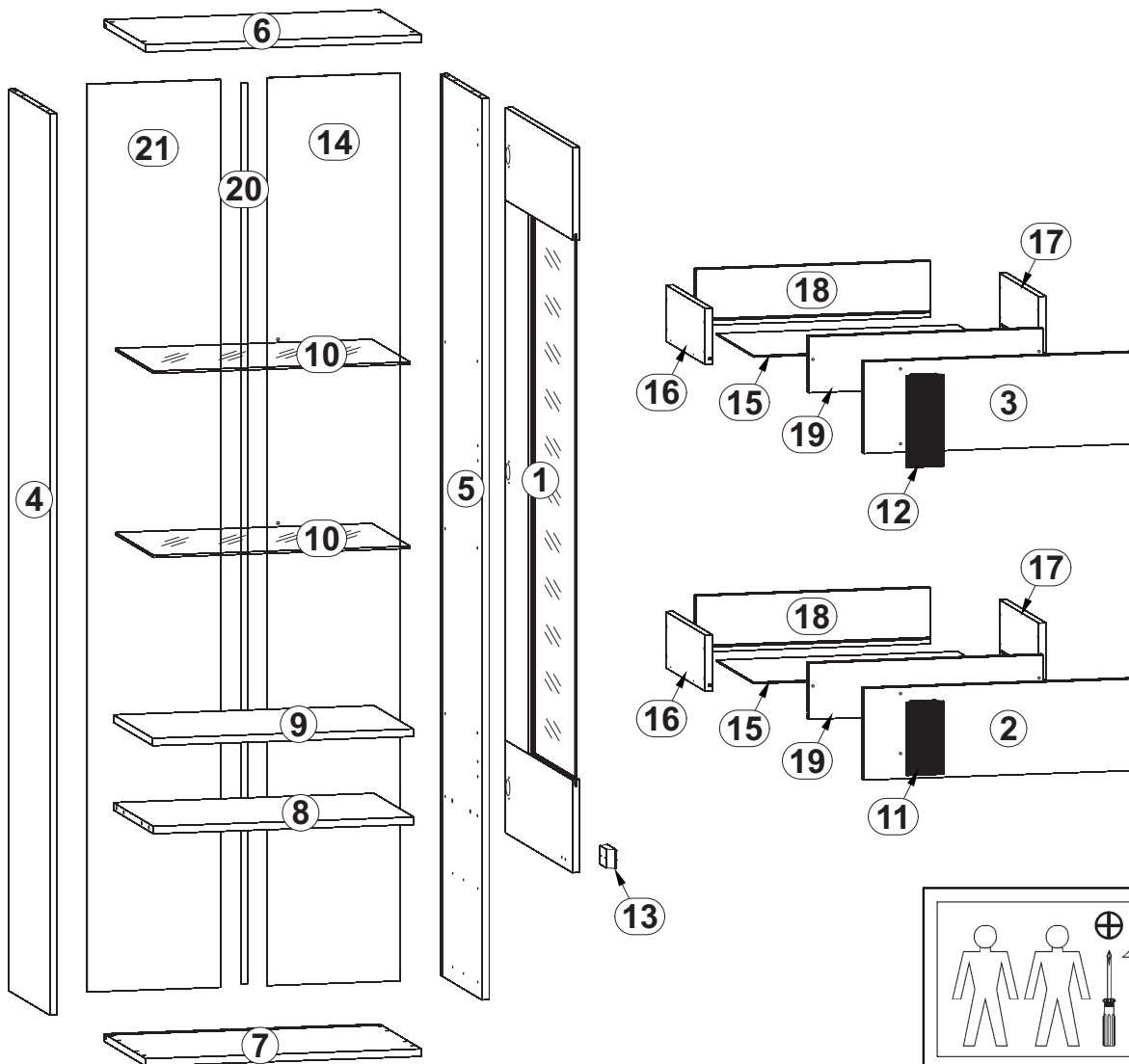

3x a44	3x b19 D5	4x d1 φ5x17 mm	8x d12	8x e1 φ7x50 mm	28x e3 φ6x13 mm	16x e32 φ5x50 mm	12x f1 φ8x30 mm
4x j30 M4x22 mm	4x k82\1	4x k82\2	6x l1	20x l2	1x n26\1	1x o99\1	
2x o99\2	1x p38 φ3,5x16 mm	6x p51 φ3,5x15 mm	8x p54 φ3x12 mm	1x p90 φ4x28 mm	5x p94 φ4x28 mm	4x r1 φ15x12mm #16	4x r31 φ21x10mm
4x r42 20/11	2x w45\CL 350 mm	2x w45\CR 350 mm	2x w45\DL 350 mm	2x w45\DR 350 mm	1x z1		

1

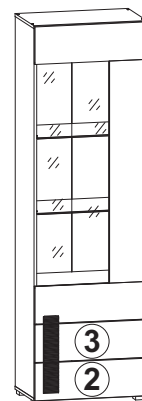
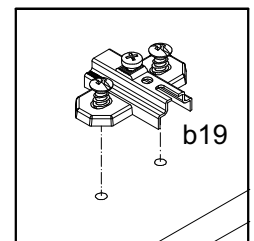
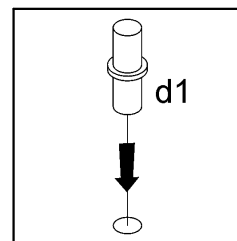
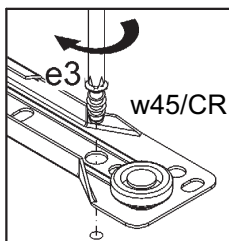
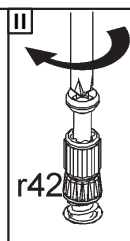
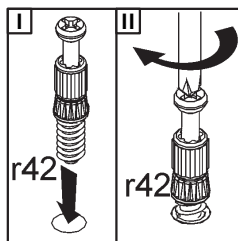
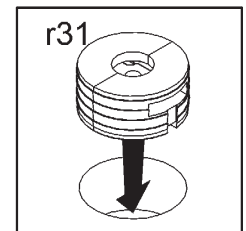
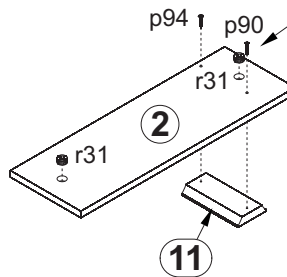
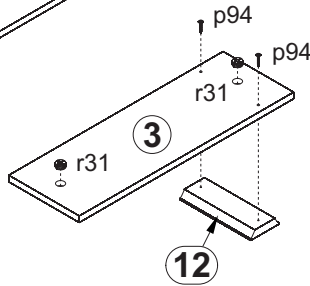
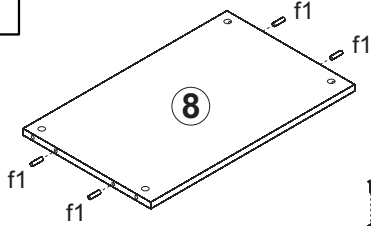
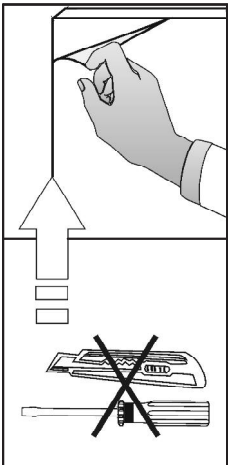
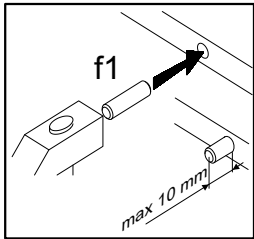
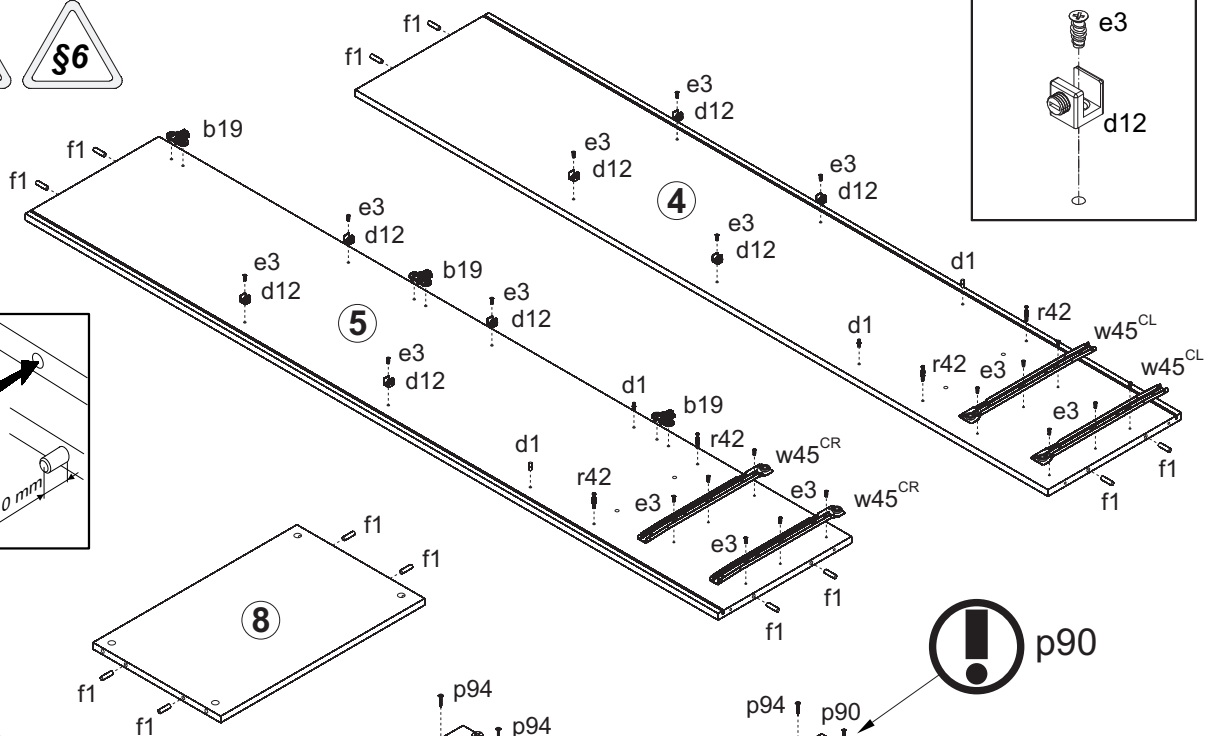

2

