

ПОЛА / POLA

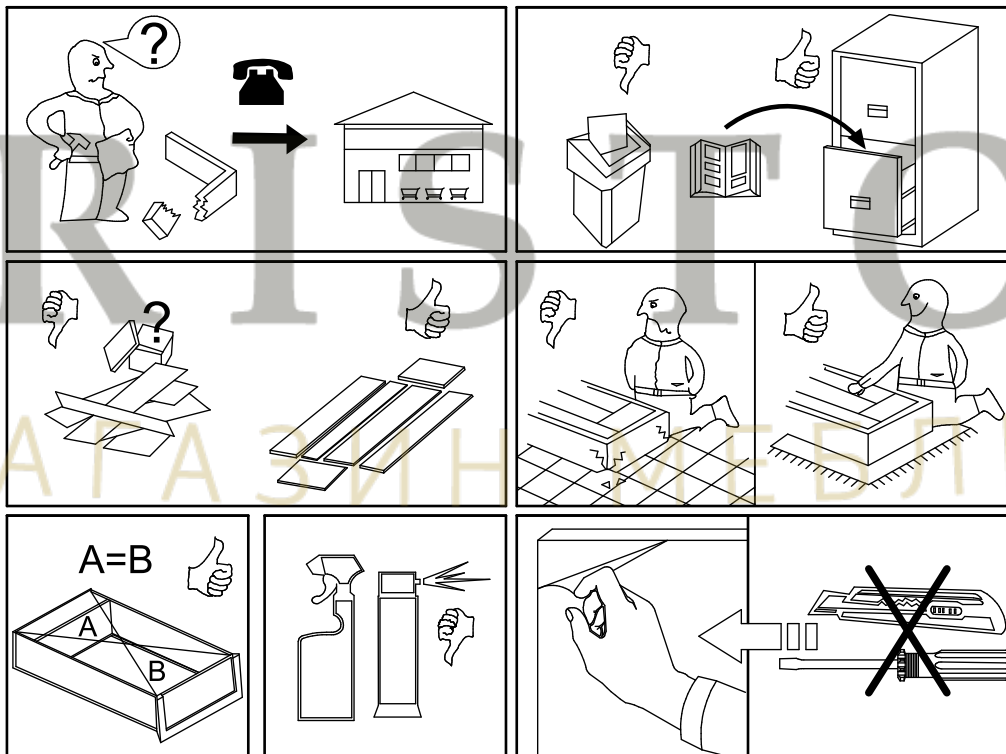

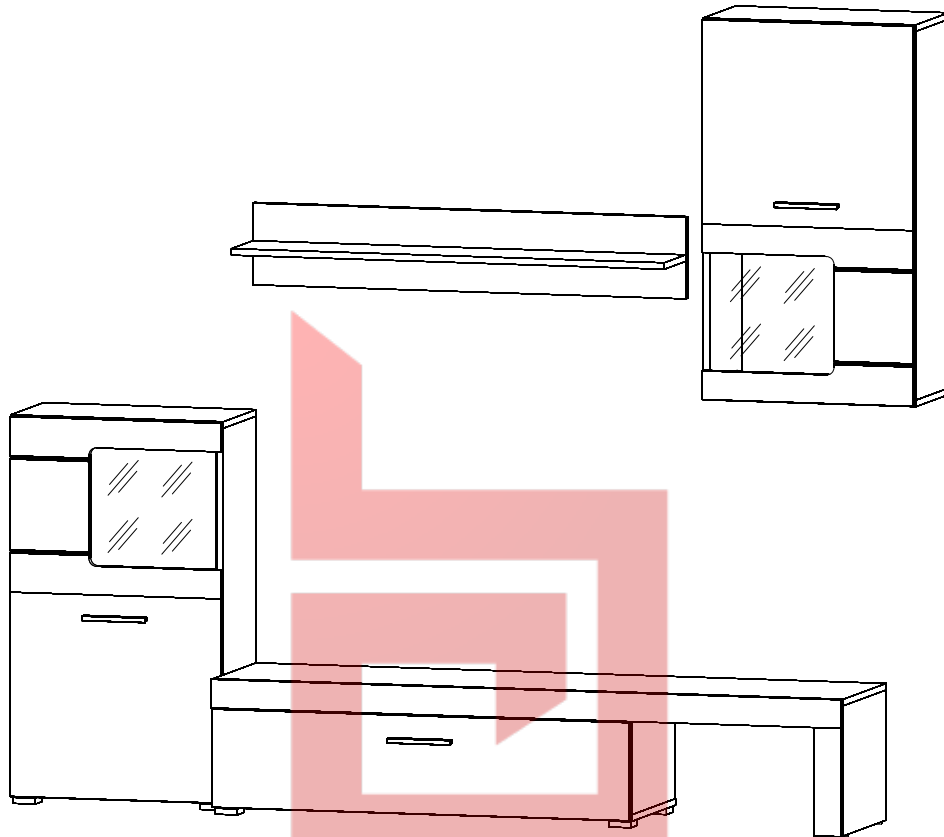

8x K0 a44	8x b19	3x c328	8x φ5x17 mm d1	13x φ7x50 mm e1	2x φ6,3x13 mm e2
4x φ5x11 mm e4	42x φ8x30 mm f1	5x φ8x50 mm f6	2x g2	2x k1	8x 56x56x20 mm k52
82x l1	12x 3 mm l3	2x m48	2x n10	1x 81x21x15/1,5mm n14	2x n122/1
1x o100	8x φ3,5x13 mm p1	2x φ3,5x13 mm p5	6x φ4x30 mm p9	20x φ4x30 mm p21	16x φ3,5x15 mm p51
12x φ3x16 mm p52	48x φ15x12mm #16 r1	5x r10	38x 20/9 r16	26x ø16 s2	4x ø16 s2
1x z1					

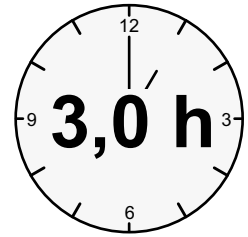
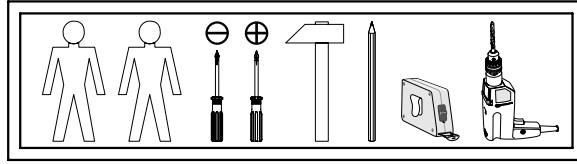
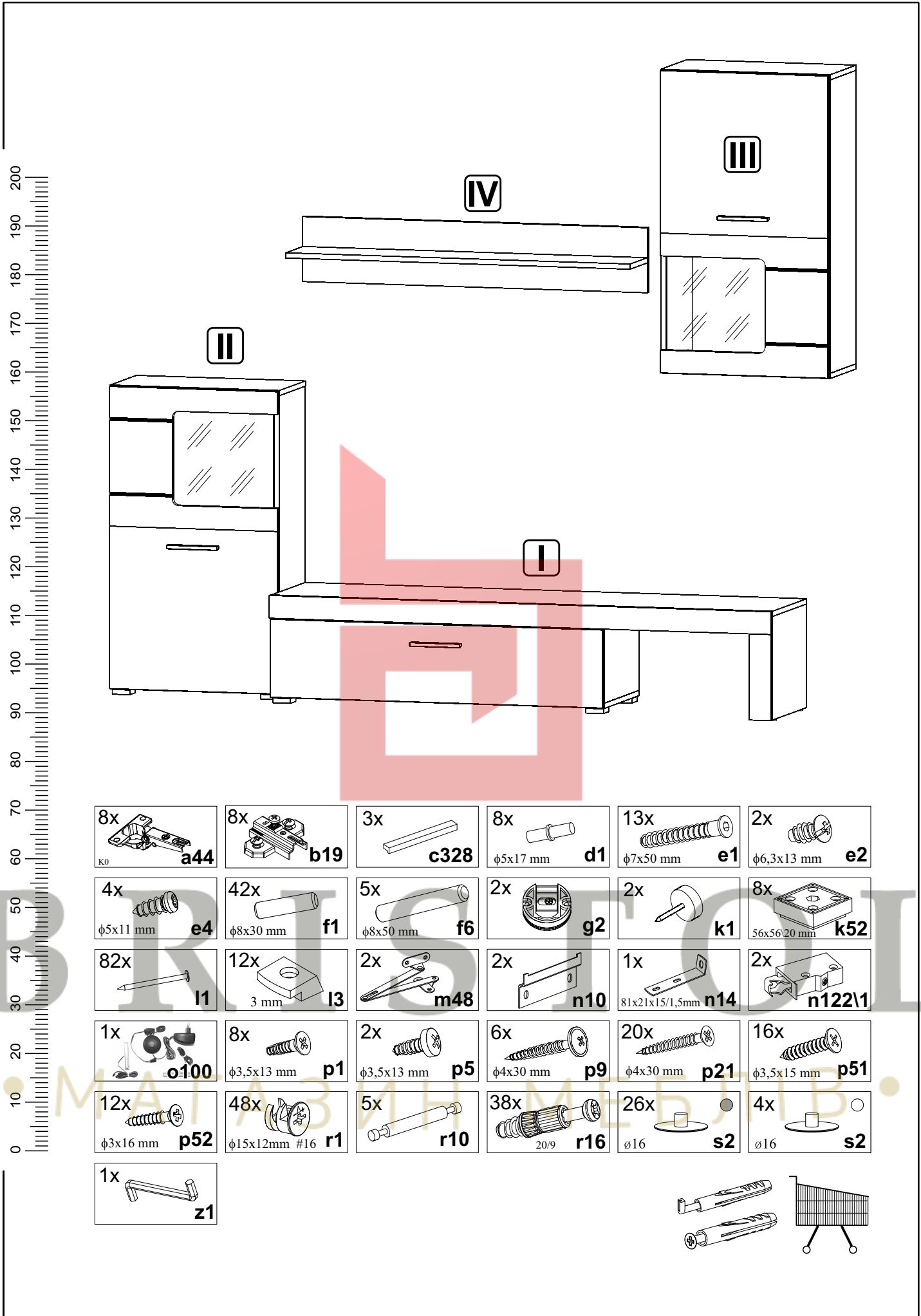
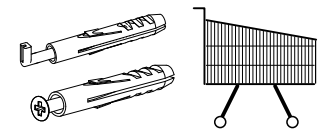



Тумба PTB / Szafka RTV

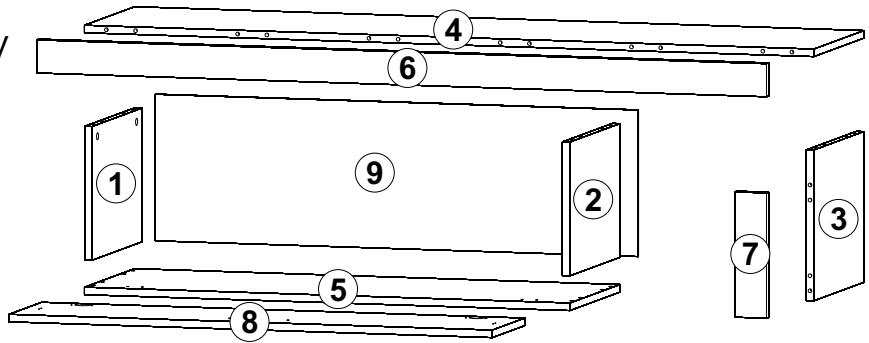
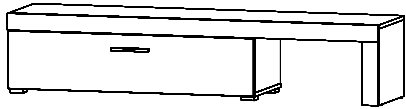

A	B	C	D
1	PRO-101	283	370
2	PRO-102	283	370
3	PRO-103	314	370
4	PRO-201	1600	370
5	PRO-202	1065	370

A	B	C	D
6	PRO-401	1601	70
7	PRO-402	261	70
8	PRO-002	1060	240
9	PRO-901	1059	310



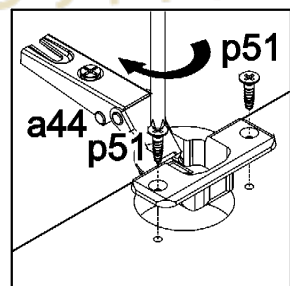
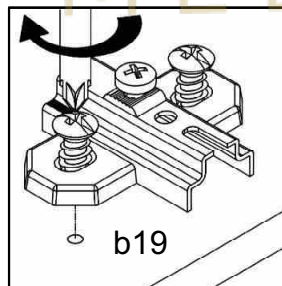
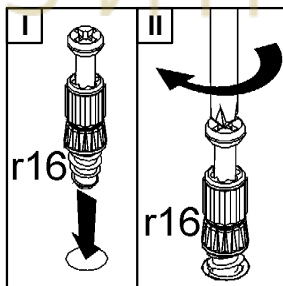
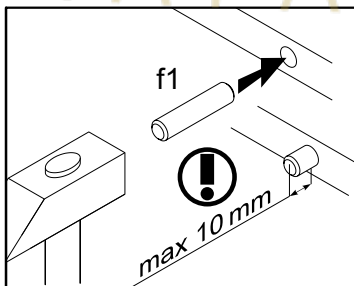
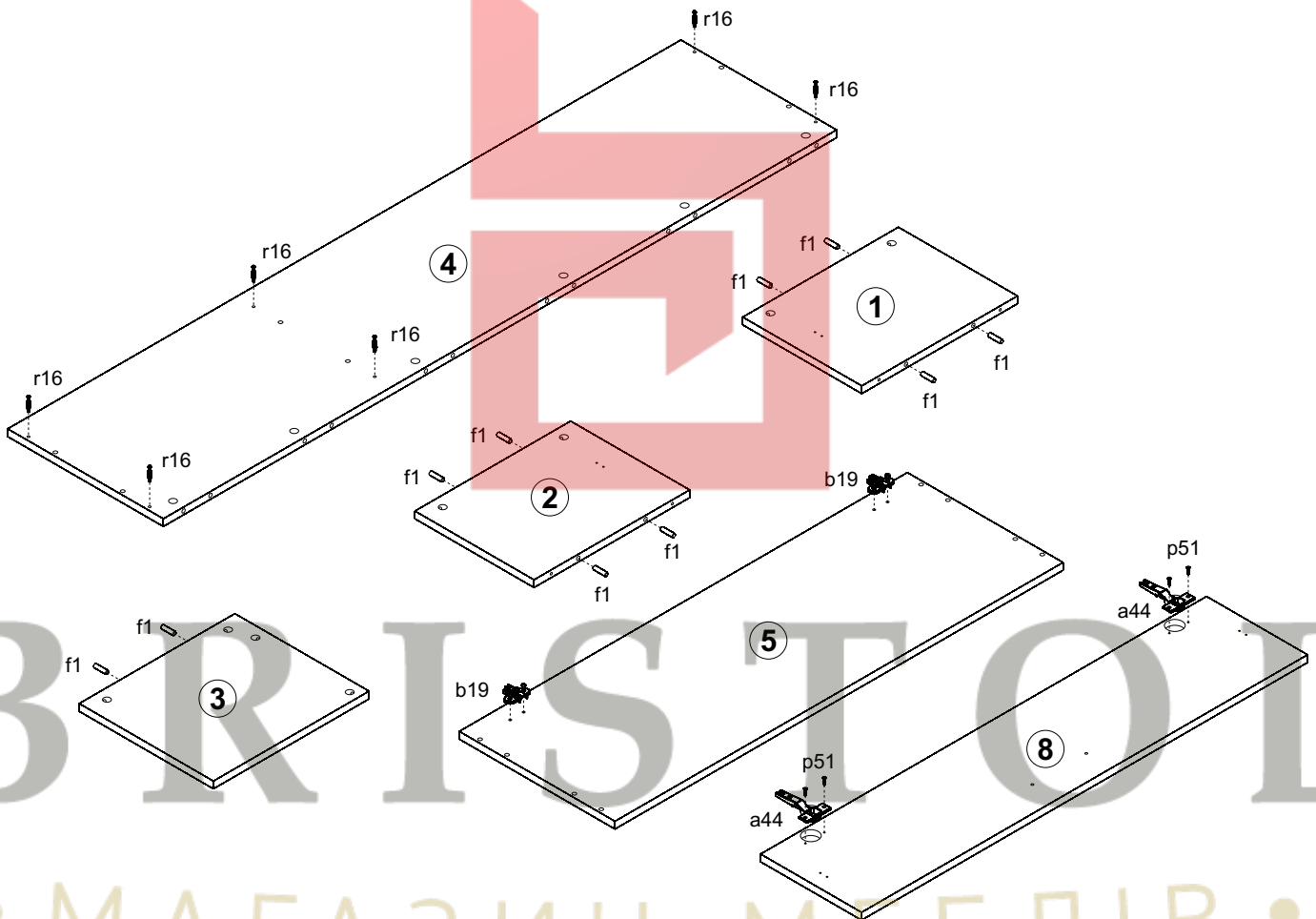
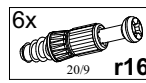
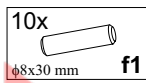
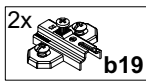
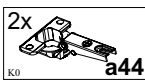

1

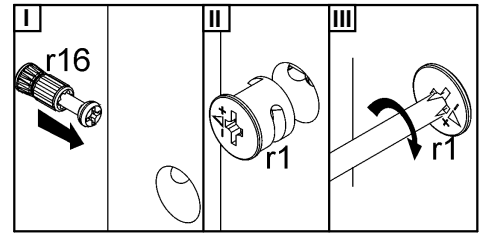
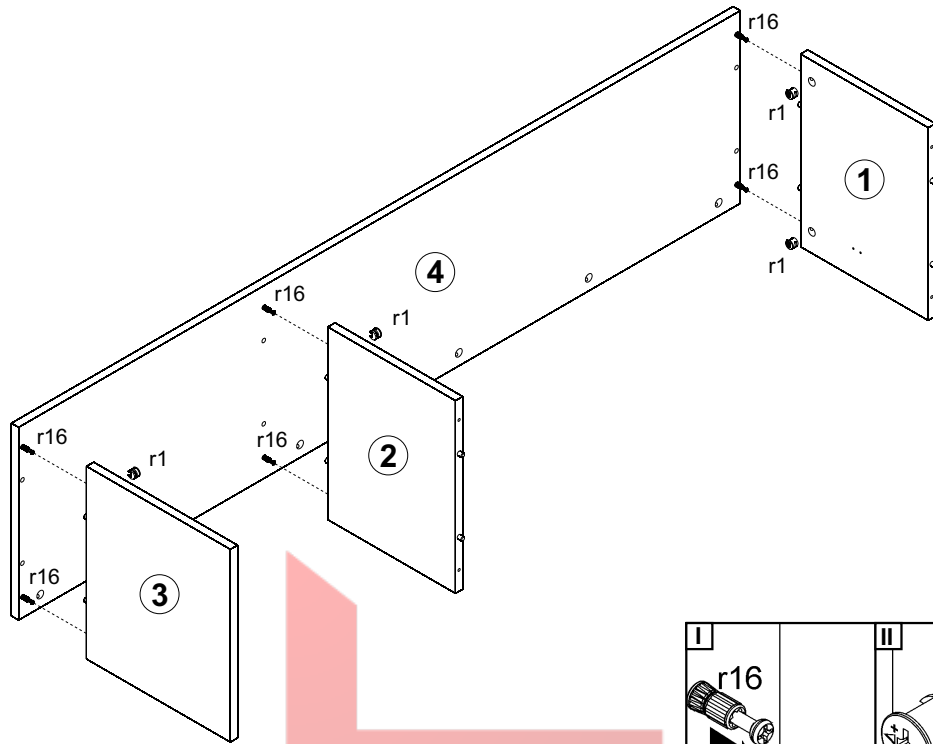

2

6x

 φ15x12mm #16 r1

**3**

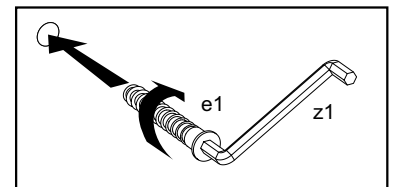
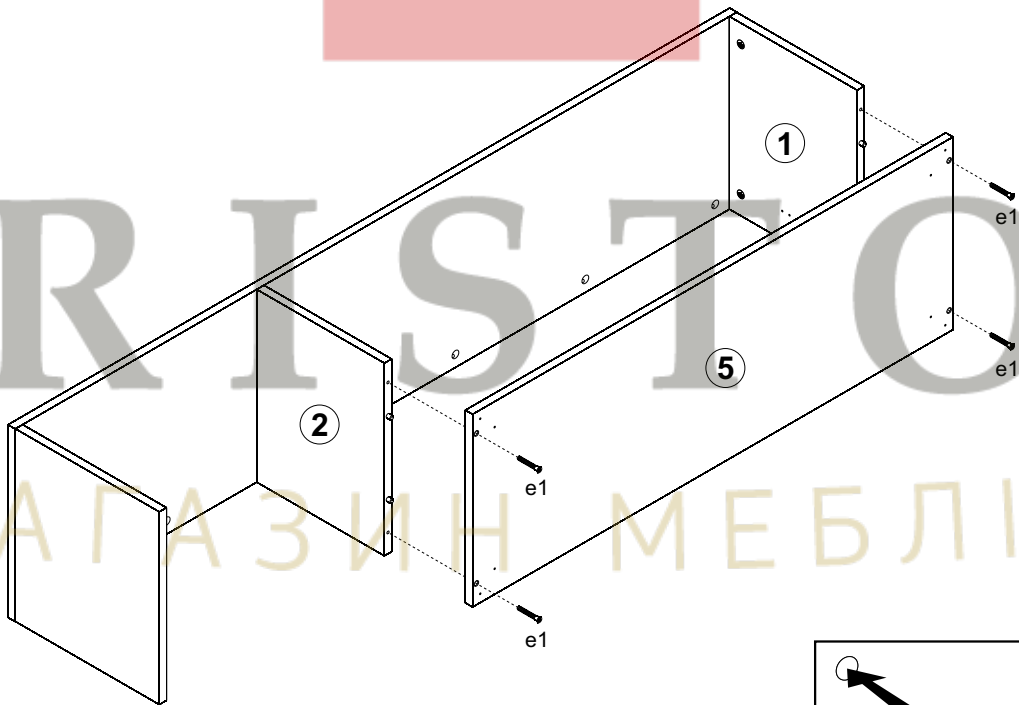
4x

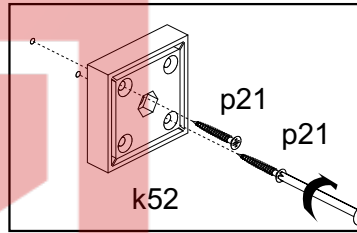
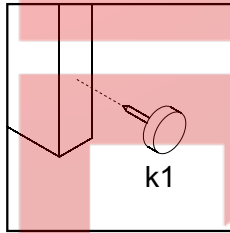
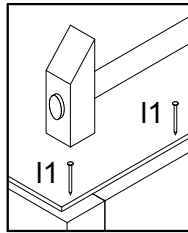
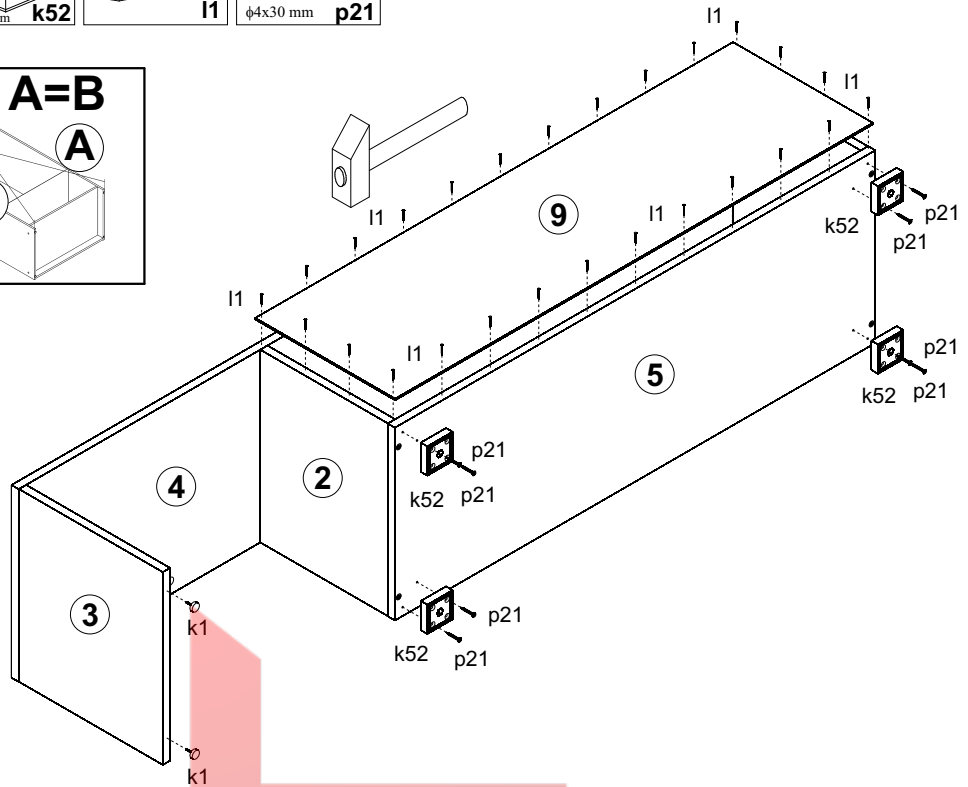
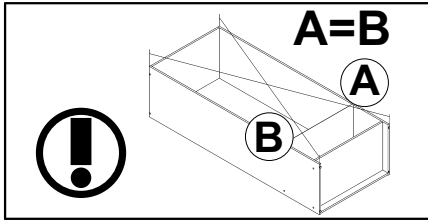
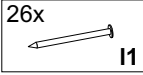
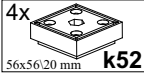
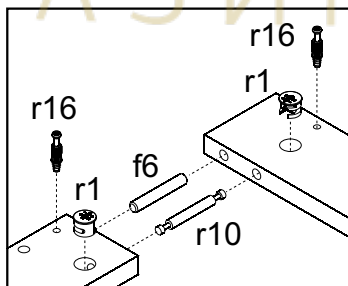
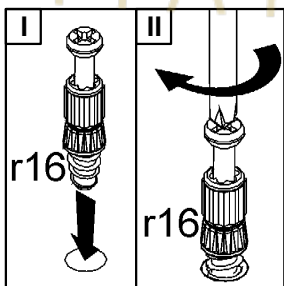
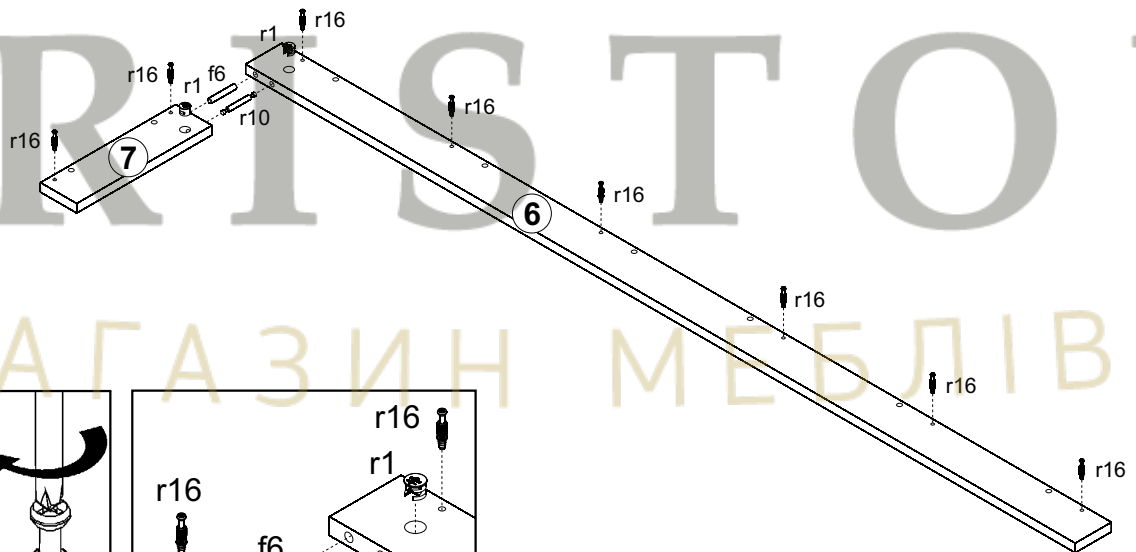
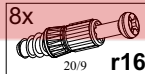
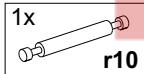
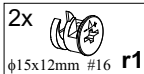
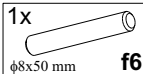
 φ7x50 mm e1

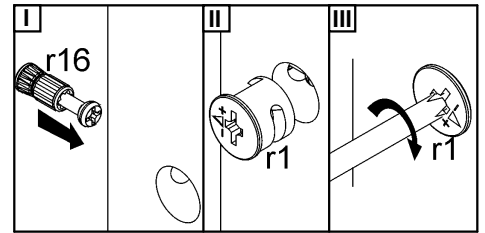
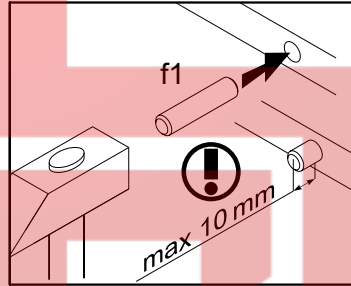
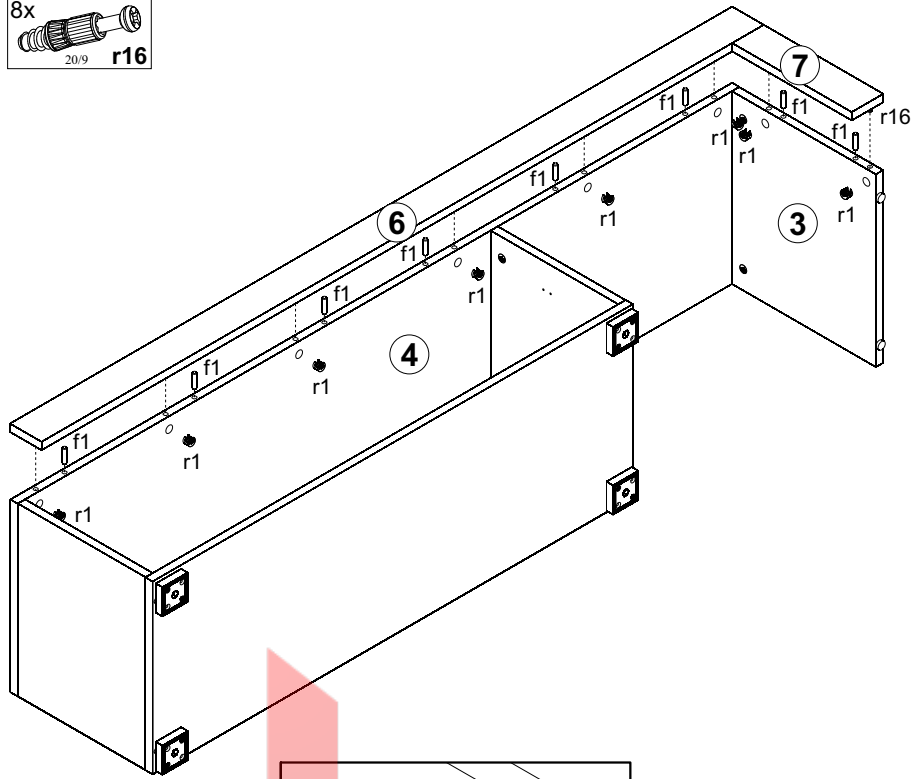
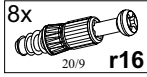
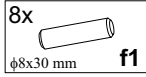
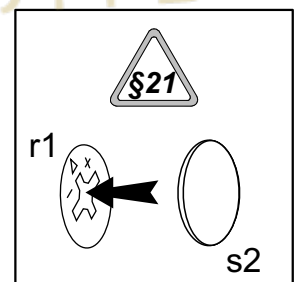
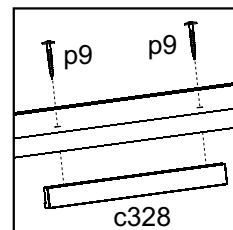
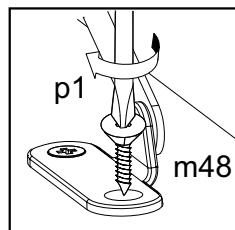
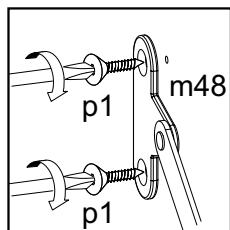
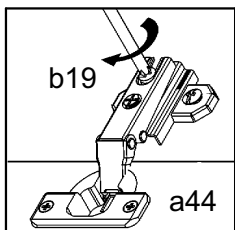
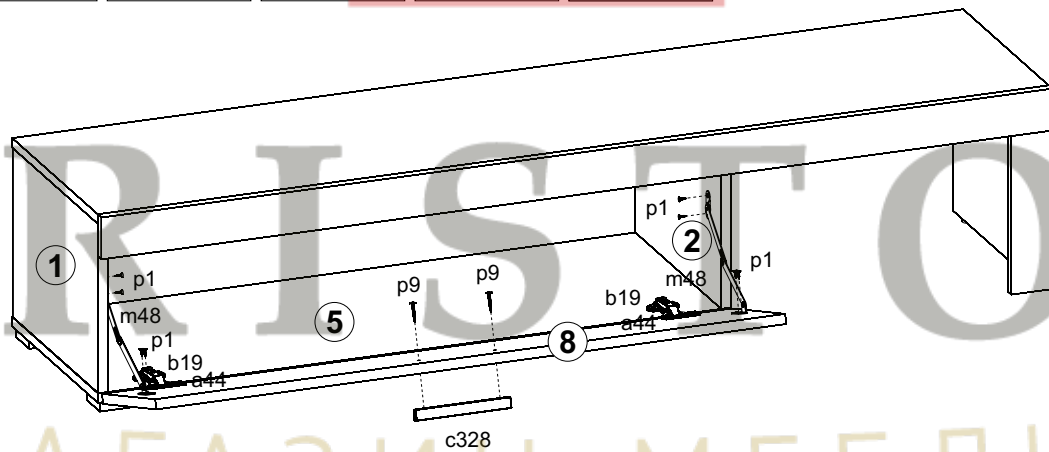
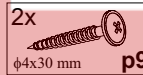
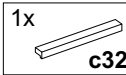

4**5**

6**7**



Вітрина / Витрина / Witryna

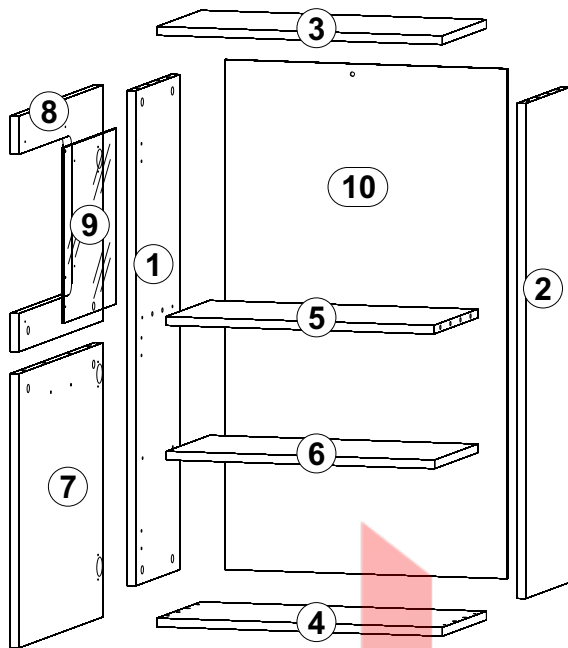
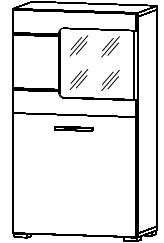

A	B	C	D	
1	PRO-104	903	280	2/3
2	PRO-105	903	280	2/3
3	PRO-203	540	280	2/3
4	PRO-204	540	280	2/3
5	PRO-301	507	280	2/3
6	PRO-302	507	275	2/3
7	PRO-003	535	500	3/3
8	PRO-004	535	430	3/3
9	PRO-501	320	334	1/3
10	PRO-905	930	534	3/3

8

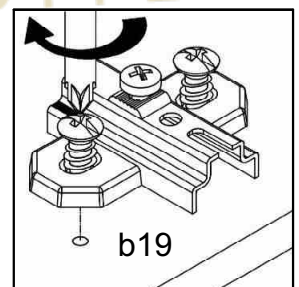
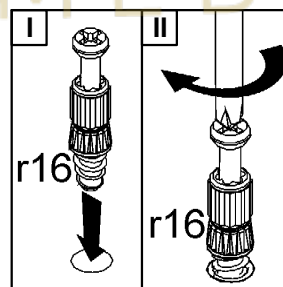
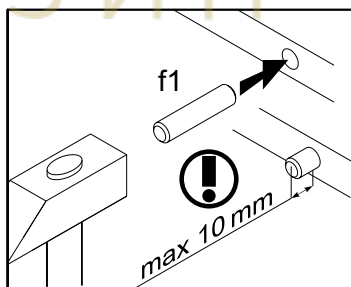
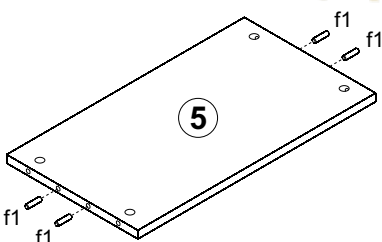
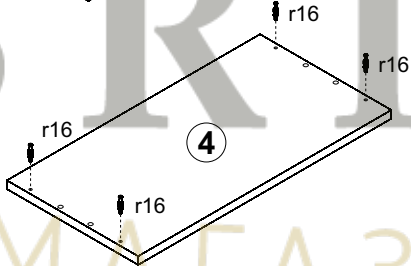
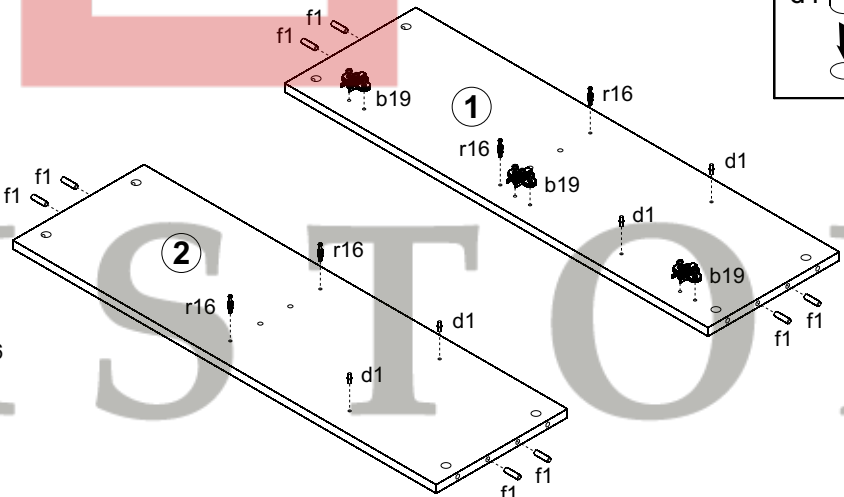
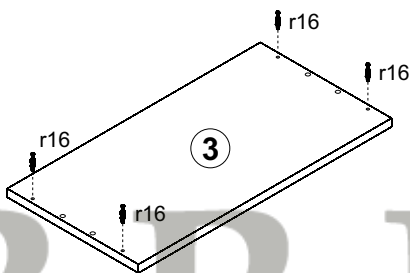
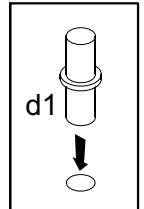
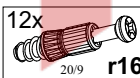
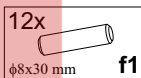
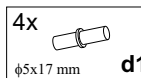
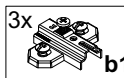

9



4x  $\phi 15 \times 12 \text{mm}$ #16 r1

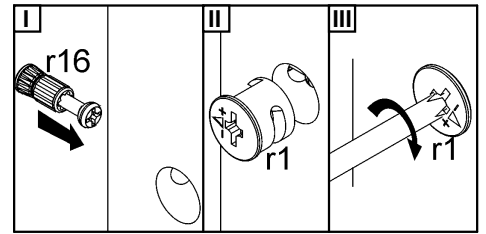
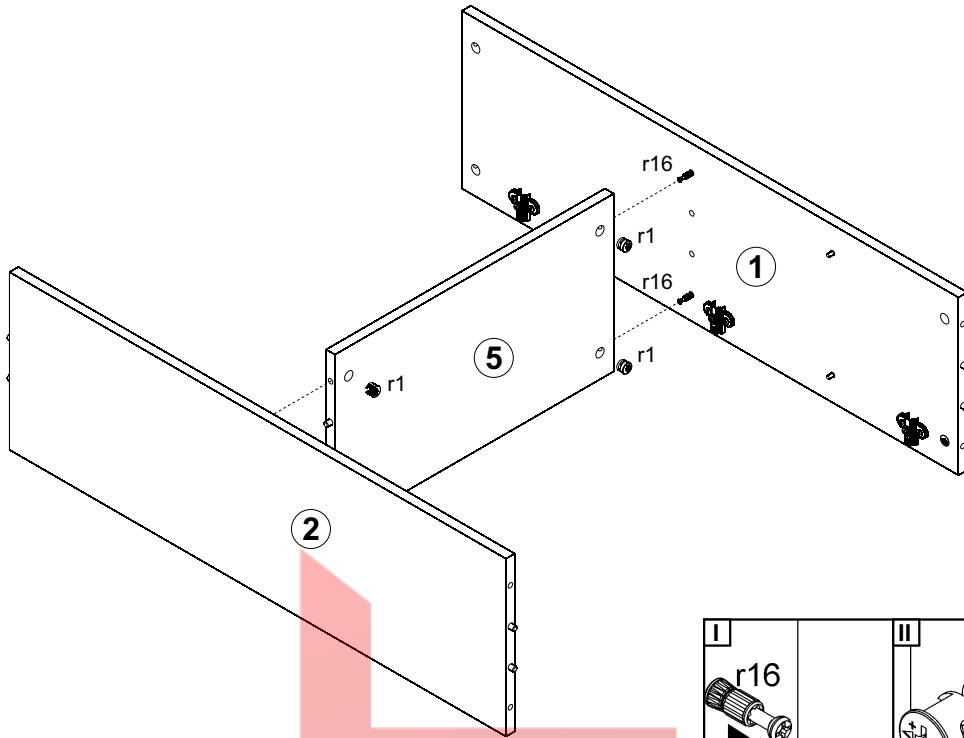

10

8x  $\phi 15 \times 12 \text{mm}$ #16 r1

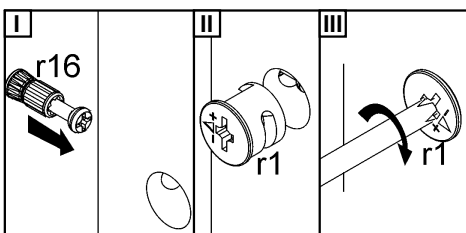
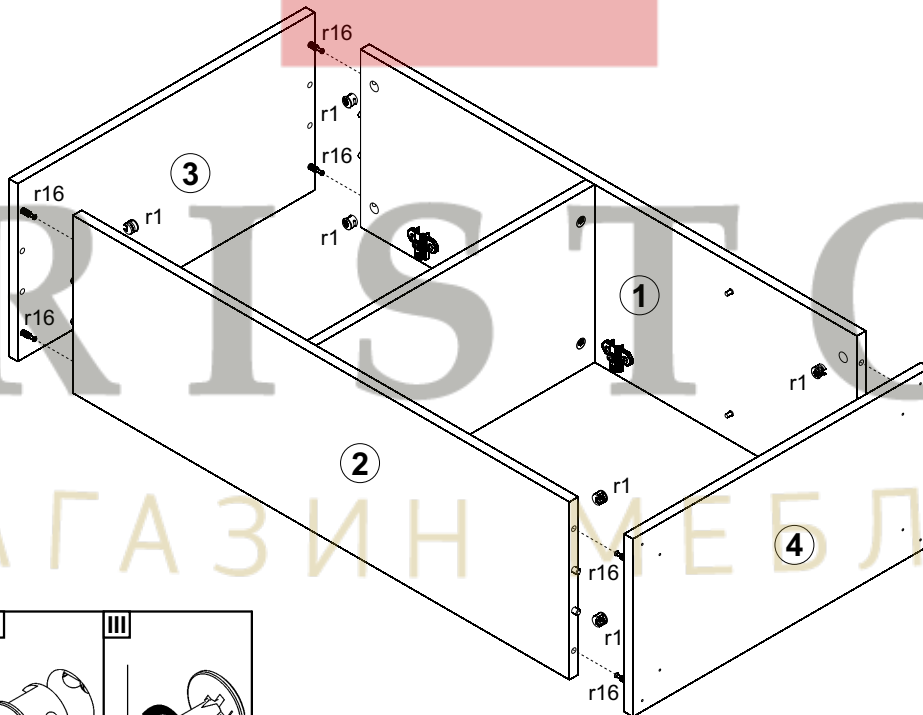

11

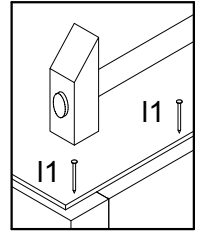
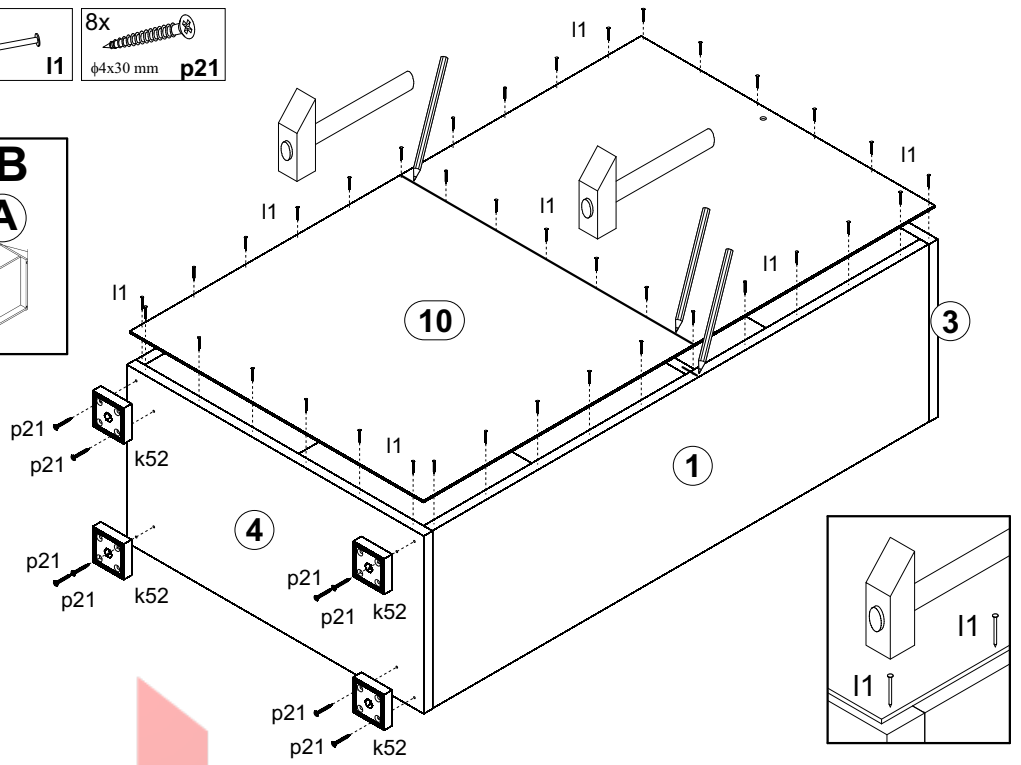
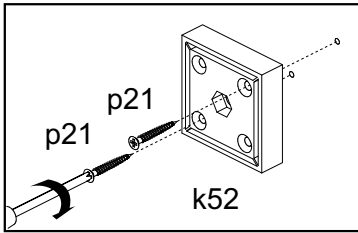
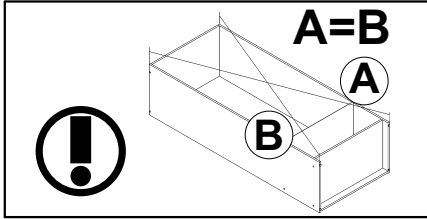
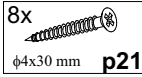
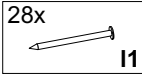
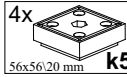

12

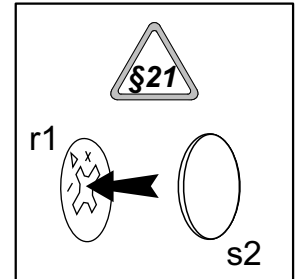
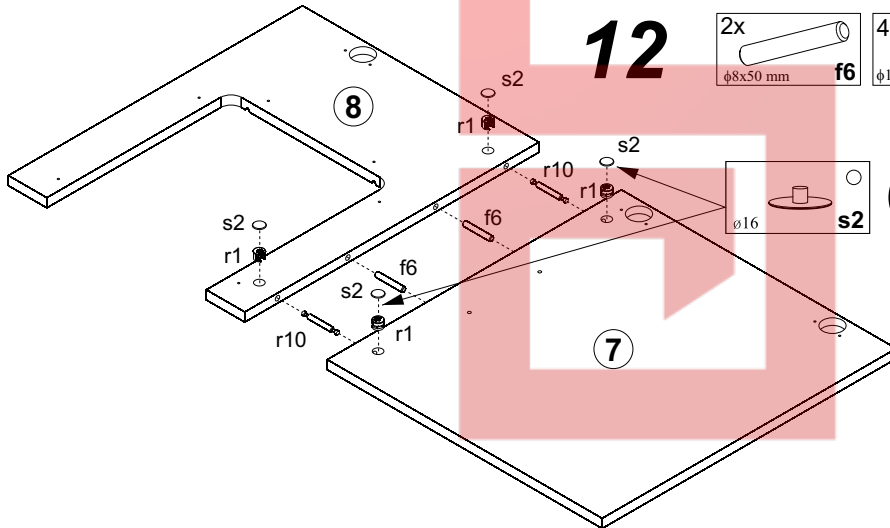
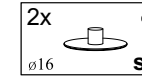
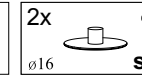
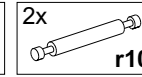
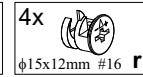
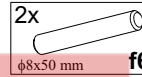

13

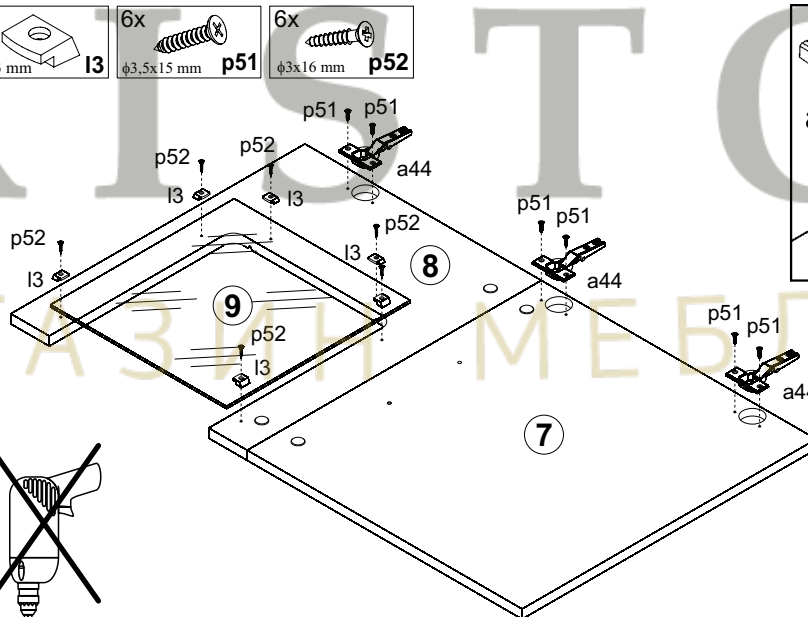
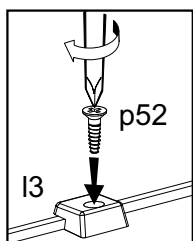
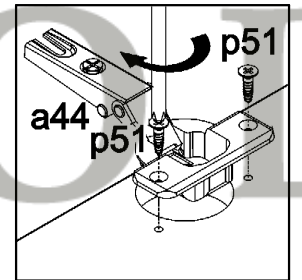
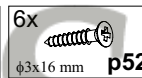
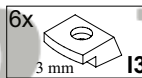
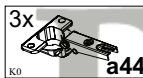

14

1x

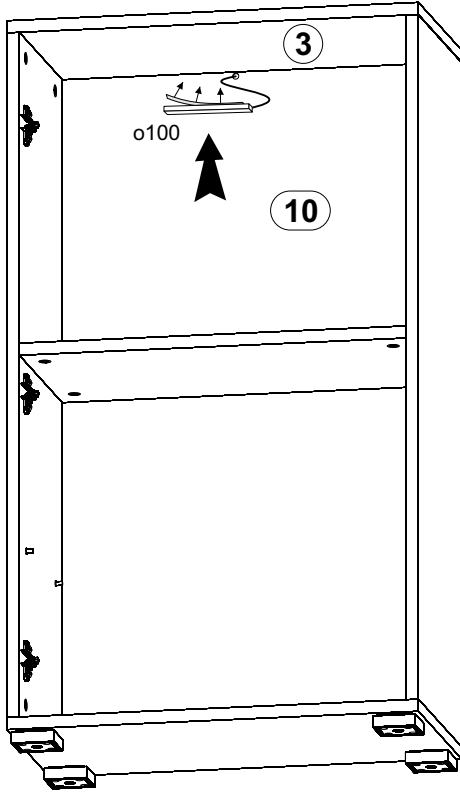

15

1x

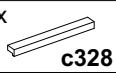

2x

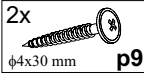

8x

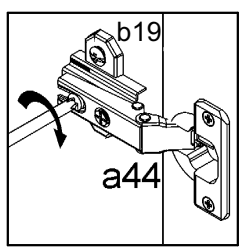
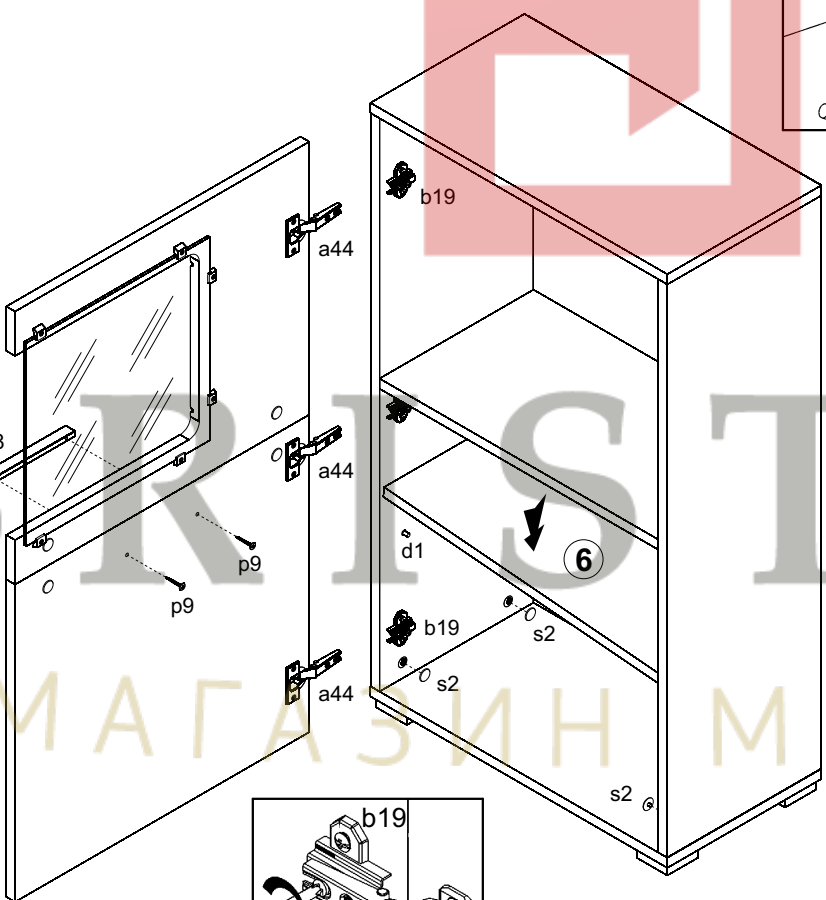
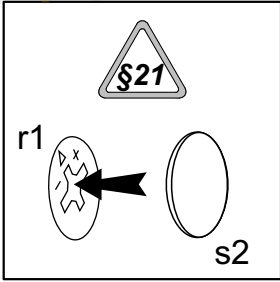
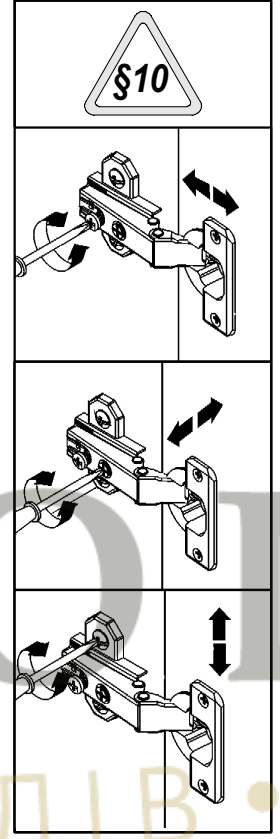
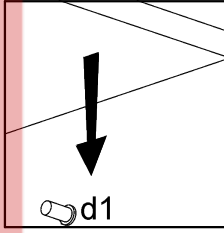
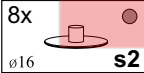



Вітрина навісна / Витрина навесная / Witryna wisząca

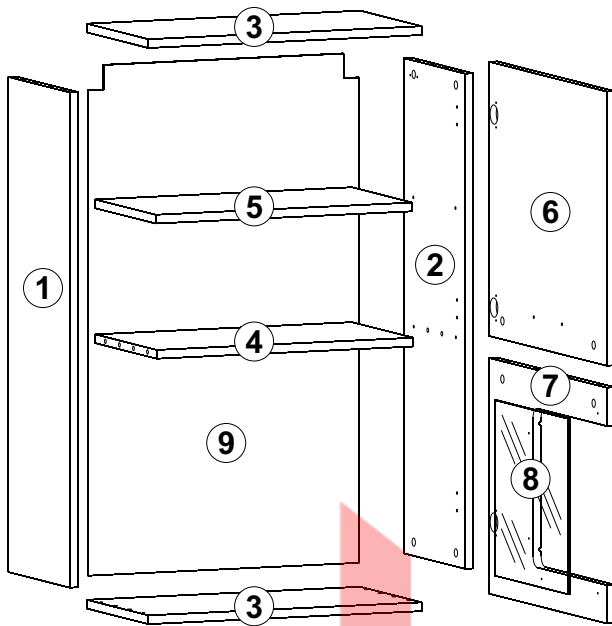
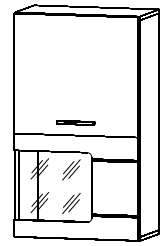

A	B	C	D	
1	PRO-106	903	280	2/3
2	PRO-107	903	280	2/3
3	PRO-203	540	280	2/3
4	PRO-301	507	280	2/3
5	PRO-302	507	275	2/3
6	PRO-003	535	500	3/3
7	PRO-004	535	430	3/3
8	PRO-501	320	334	1/3
9	PRO-903	930	534	3/3

16

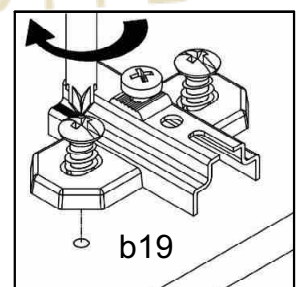
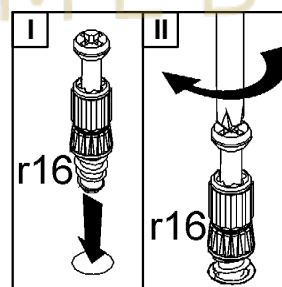
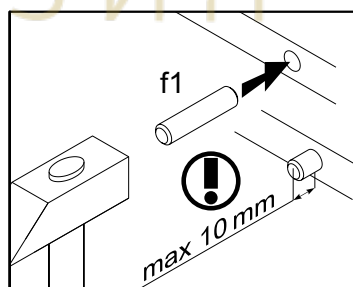
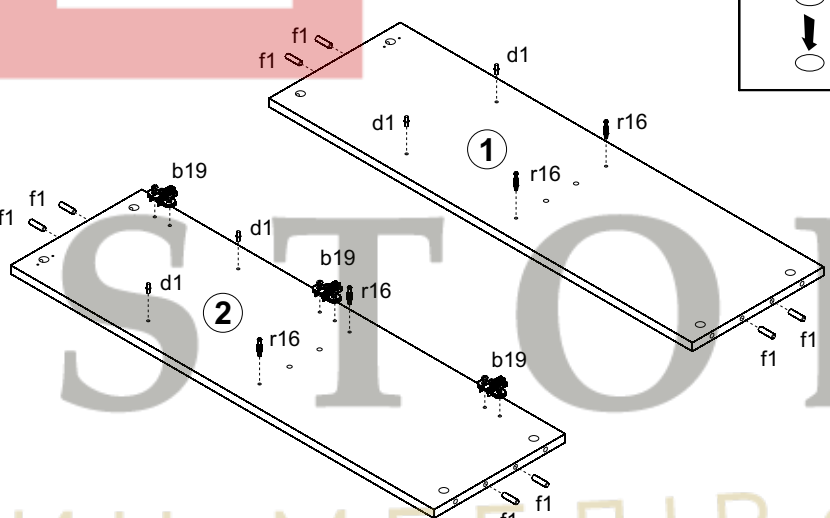
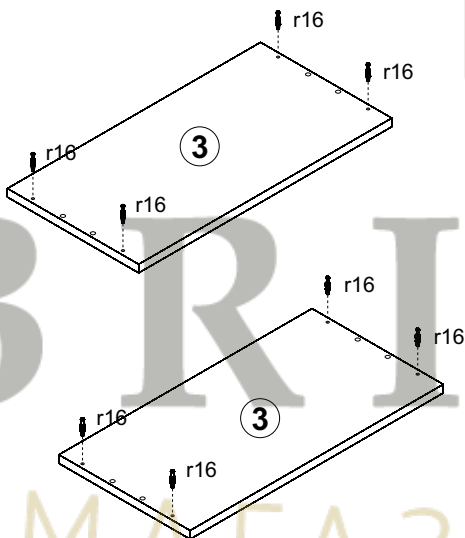
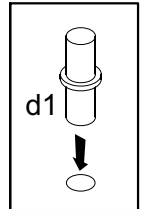
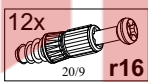
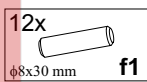
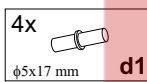
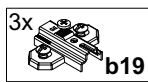

17



4x  $\phi 15 \times 12 \text{mm}$ #16 r1

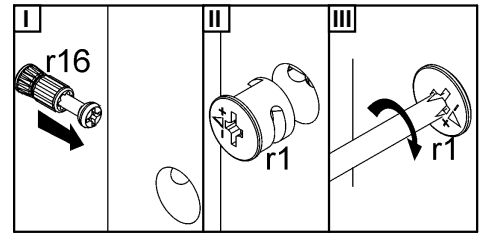
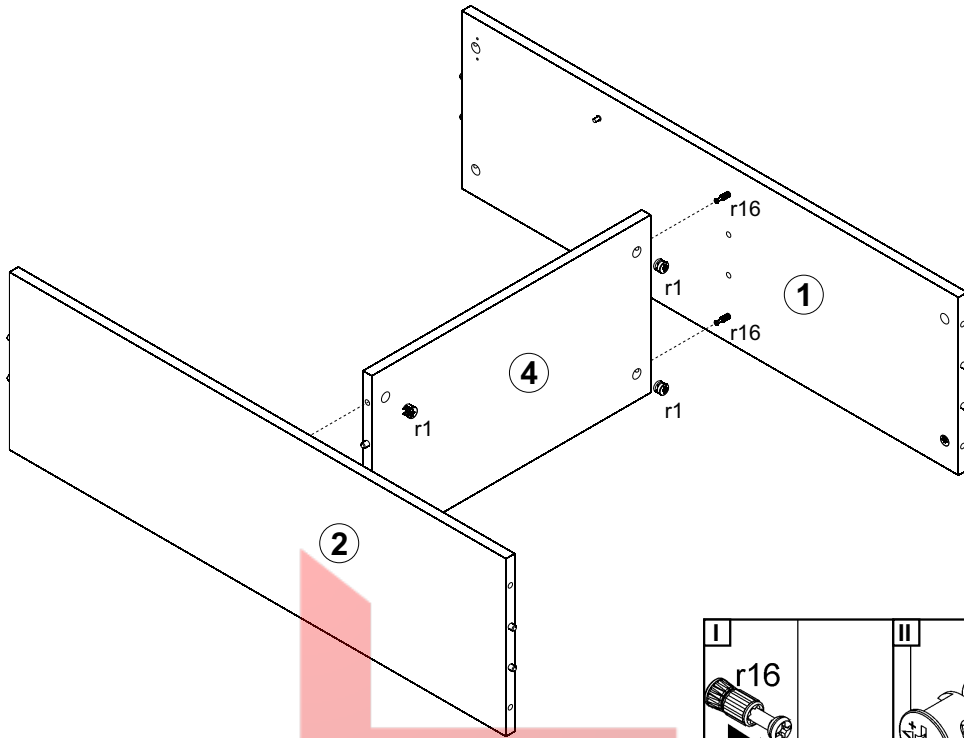

18

8x  $\phi 15 \times 12 \text{mm}$ #16 r1

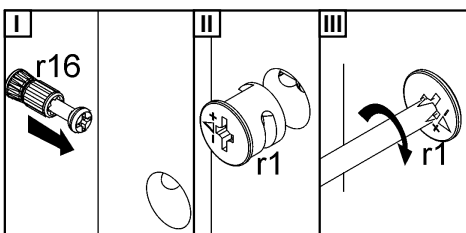
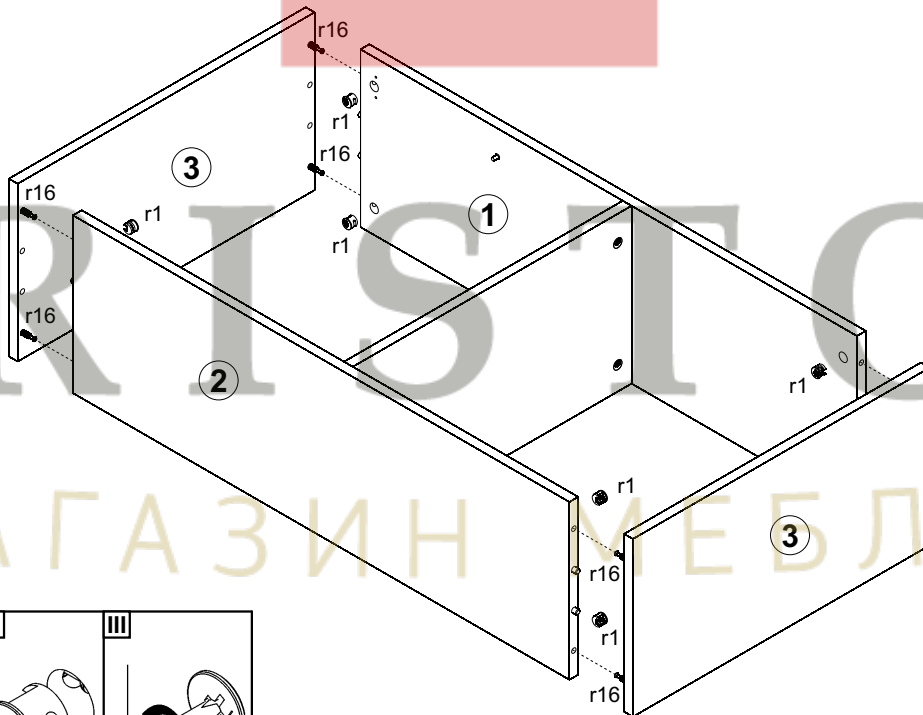

19

28x
I1

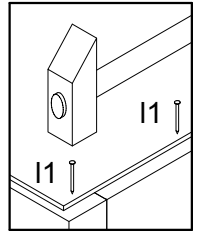
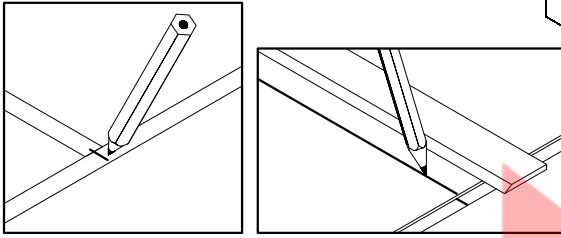
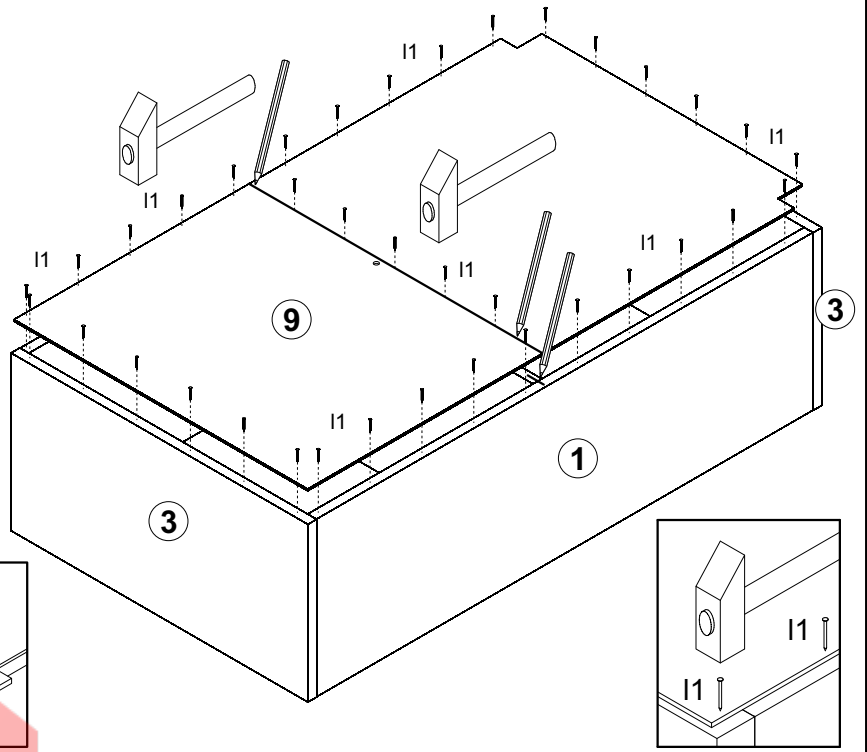
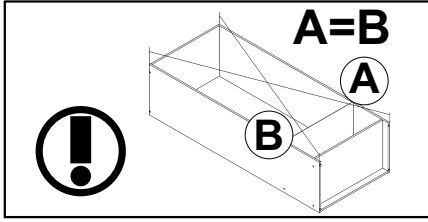

12

2x
φ8x50 mm f6

4x
φ15x12mm #16 r1

2x
r10

2x
φ16 s2

2x
φ16 s2

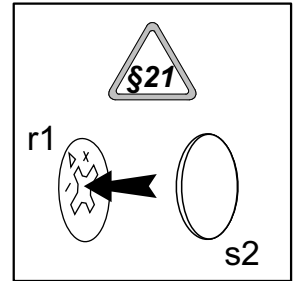
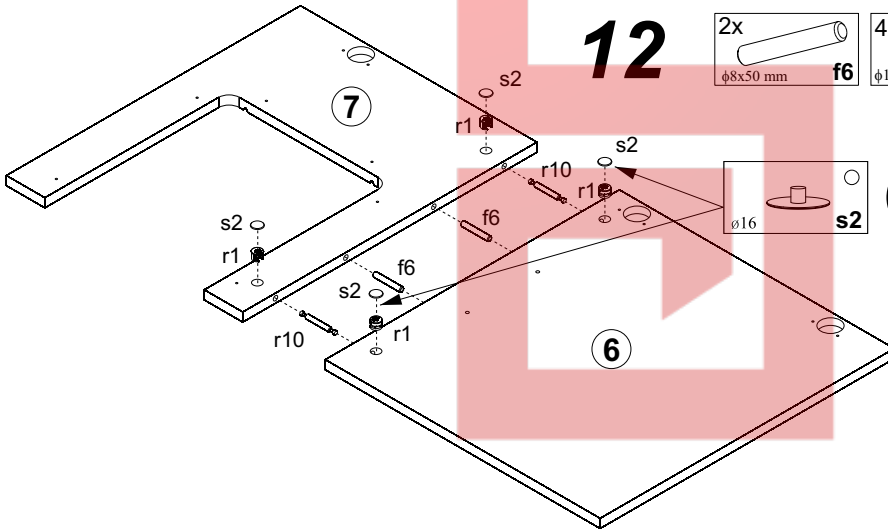

21

3x
a44

6x
3 mm I3

6x
φ3,5x15 mm p51

6x
φ3x16 mm p52

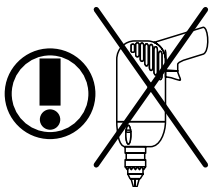
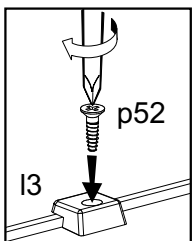
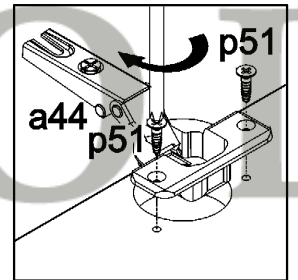
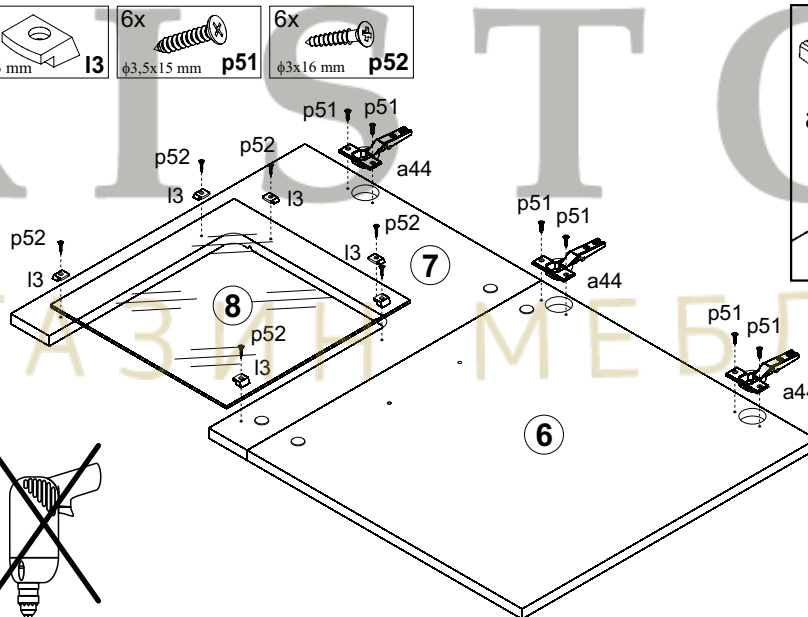

22

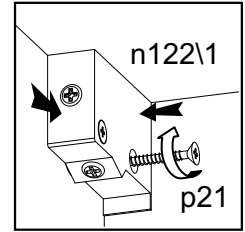
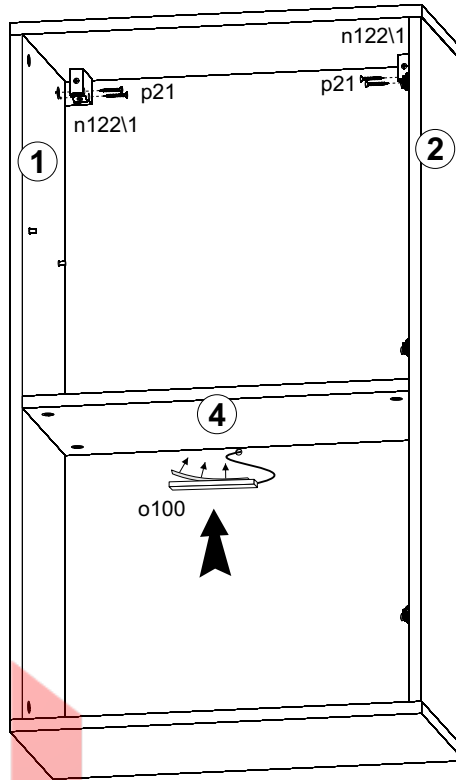
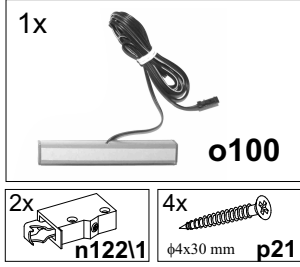

23

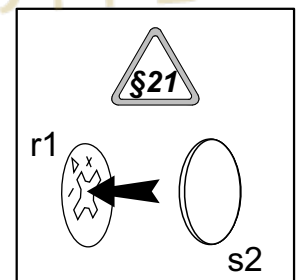
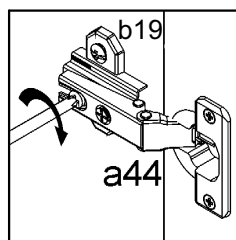
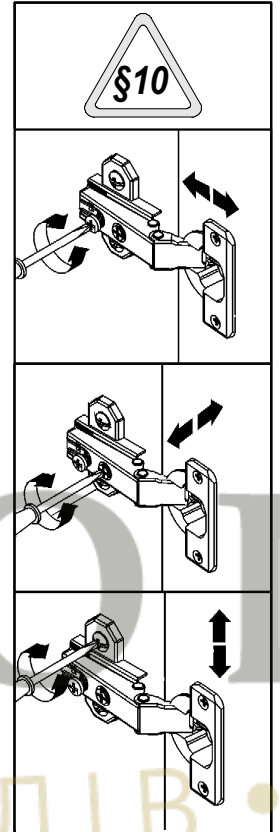
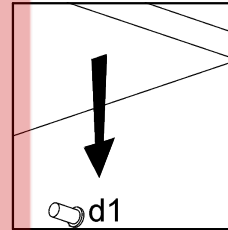
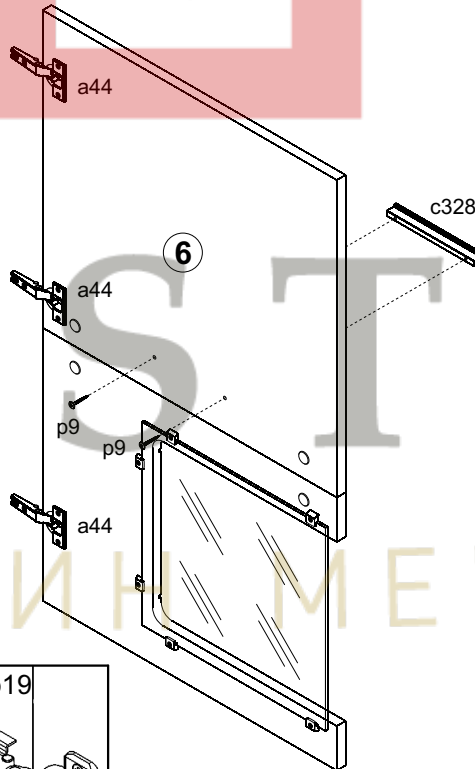
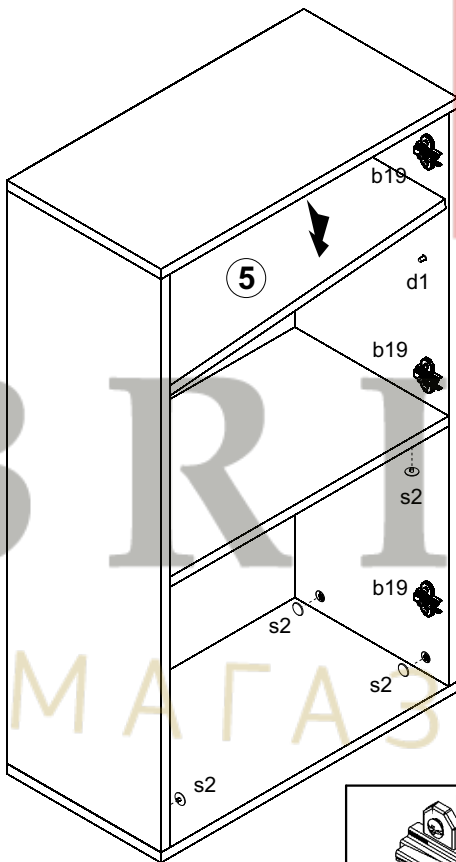
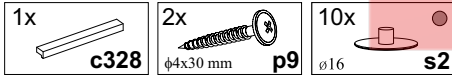

IV Полиця / Полка / Półka

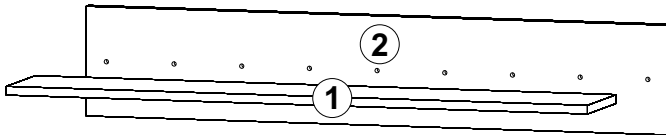
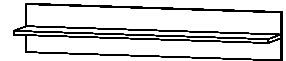

A	B	C	D
1	PRO-303	1099	184
2	PRO-403	1100	200



24



2x g2



4x $\phi 5 \times 11$ mm e4



2x $\phi 6,3 \times 13$ mm e2

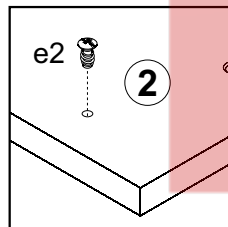
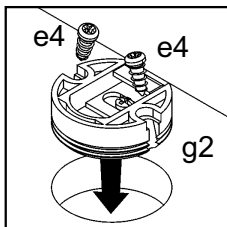
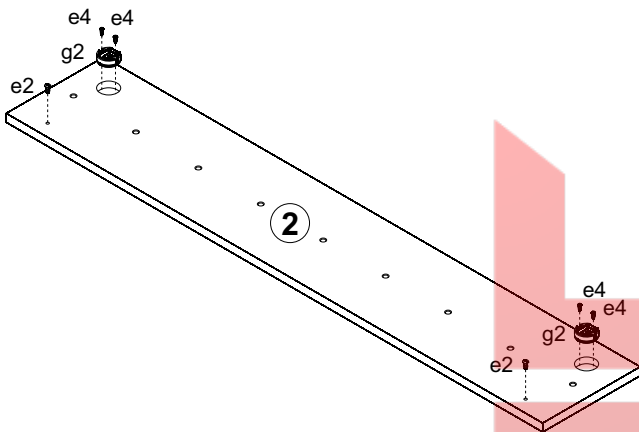

25



9x $\phi 7 \times 50$ mm e1

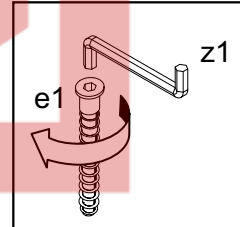
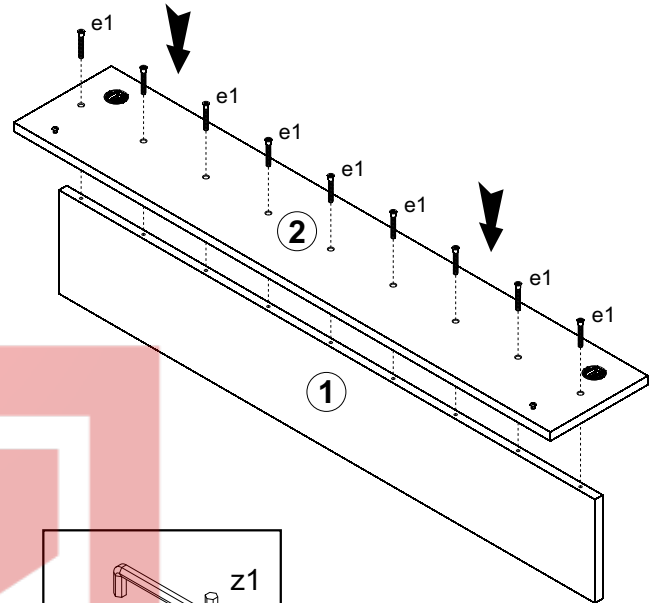

26

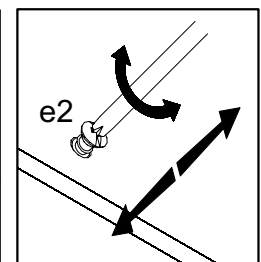
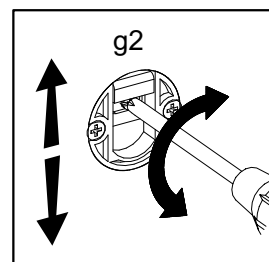
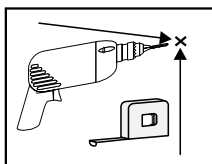
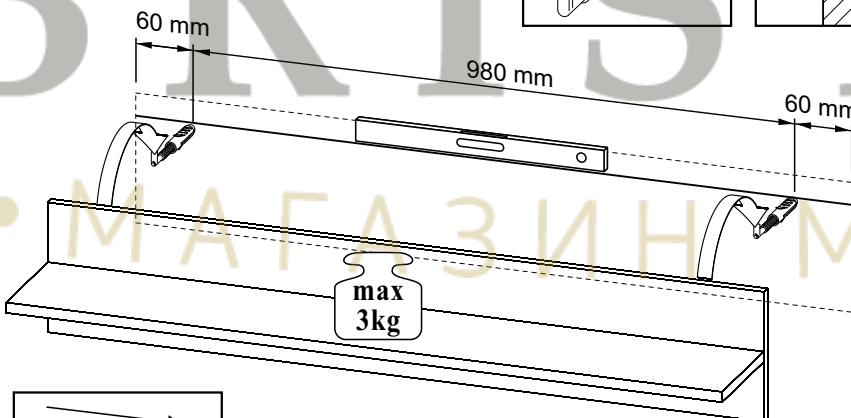
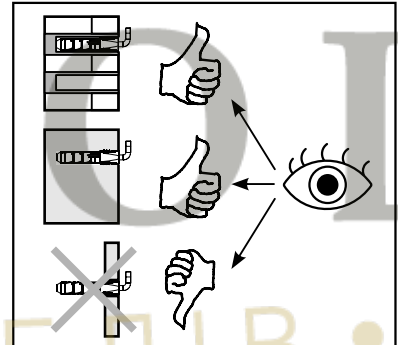
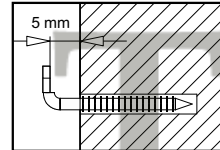
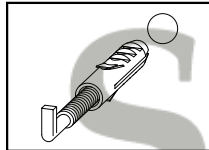
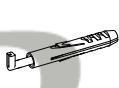

27

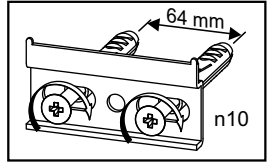
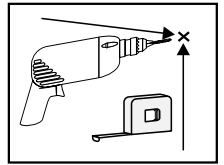
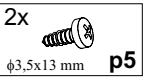
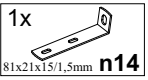
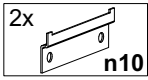
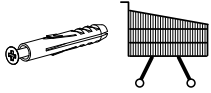

25 mm 64 mm

64 mm 25 mm

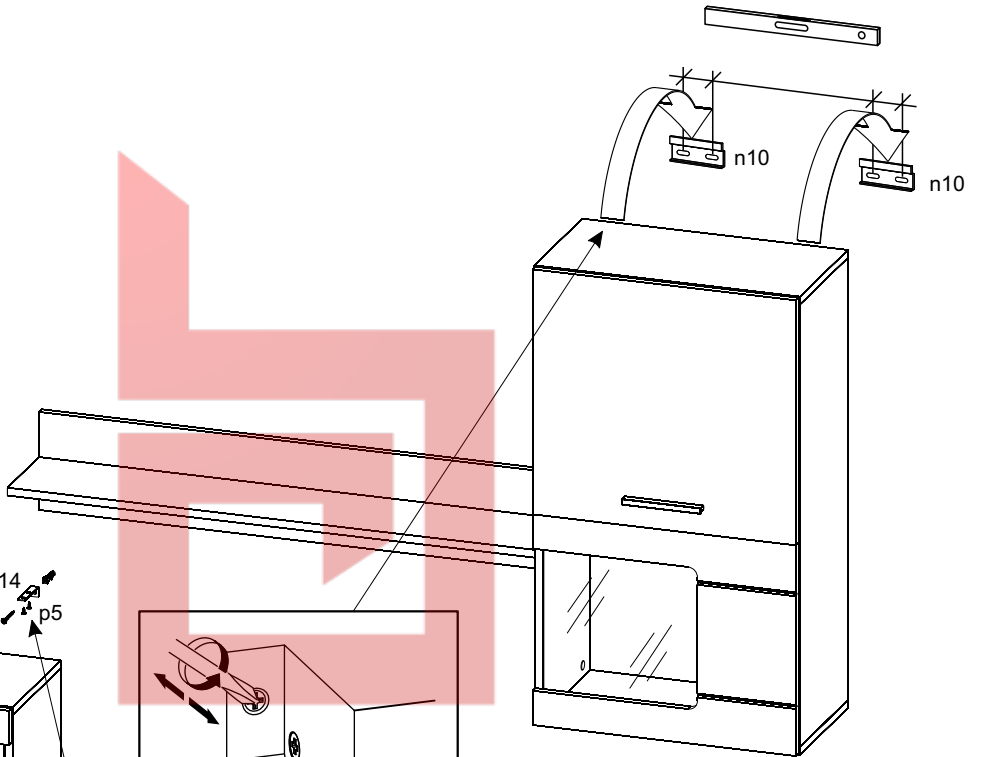
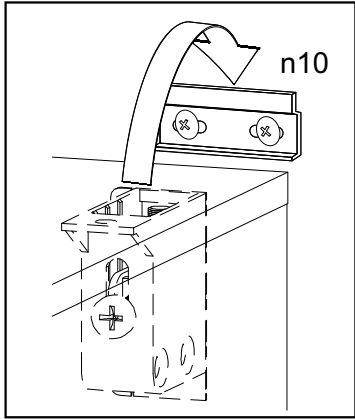

n14 p5

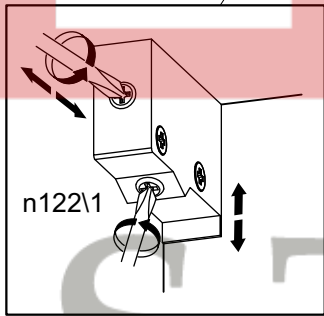

n122/1

