

A	B	C	D	A	B	C	D	A	B	C	D			
1	AN1-145	2092	575	1/7	9	AN1-328	2332	575	3/7	17	AN1-331	933	570	5/7
2	AN1-146	2092	575	1/7	10	AN1-462	2092	80	4/7	18	AN1-332	933	570	5/7
3	AN1-923	2045	476	1/7	11	AN1-463	2092	80	4/7	19	AN1-333	933	570	5/7
4	AN1-922	2045	448	1/7	12	AN1-464	2092	62	4/7	20	AN1-466	933	160	5/7
5	LH-2005	2005	14	1/7	13	AN1-465	2092	80	4/7	21	DR-928	928		5/7
6	AN1-147	2006	575	2/7	14	AN1-512	200	70	4/7	22	AN1-027	2016	446	6/7;7/7
7	AN1-148	2006	575	2/7	15	AN1-329	434	570	5/7	23	AN1-028	2016	446	6/7;7/7
8	AN1-212	2410	610	3/7	16	AN1-330	434	570	5/7					

8x a99	12x a205	8x b43	12x b51	5x c390	20x φ5x17 mm d1	4x φ6x15 mm d4	14x φ7x50 mm e1
16x φ6,3x13 mm e2	20x φ7x28 mm e22	36x φ8x30 mm f1	8x k1	195x l1	6x n1	1x n26/1	6x φ3,5x13 mm p1
5x φ4x35 mm p26	17x φ3,5x16 mm p38	40x φ3,5x15 mm p51	36x φ15x12mm #16 r1	36x r16	12x φ20x12mm #16 r36	12x 6,7/7,8 r37	16x s1
25x φ16 s2	1x z1						

1

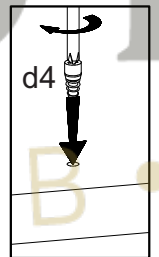
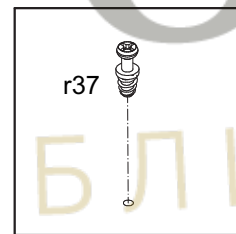
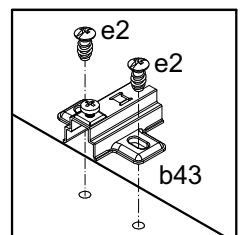
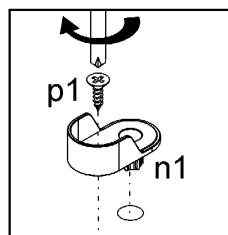
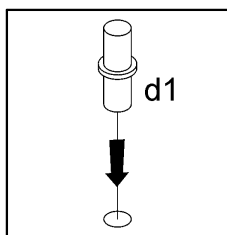
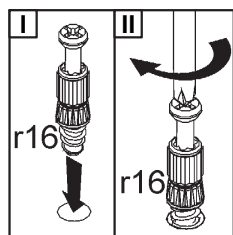
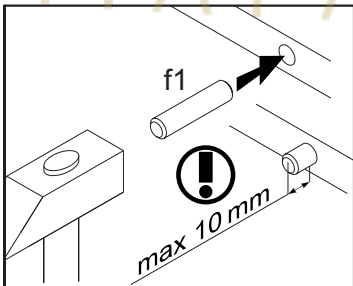
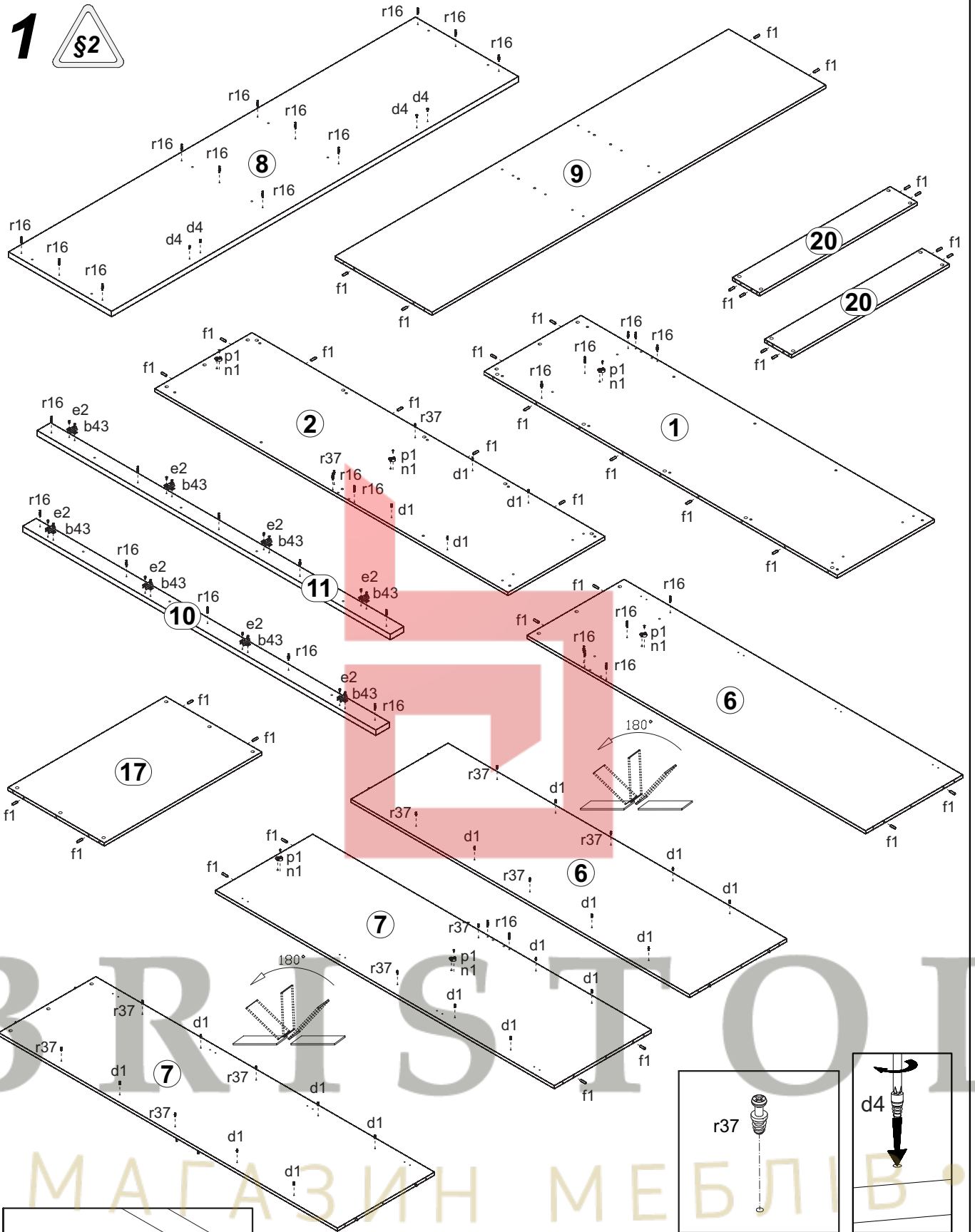

2

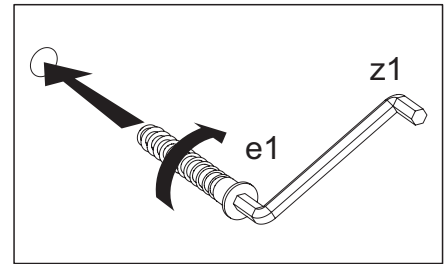
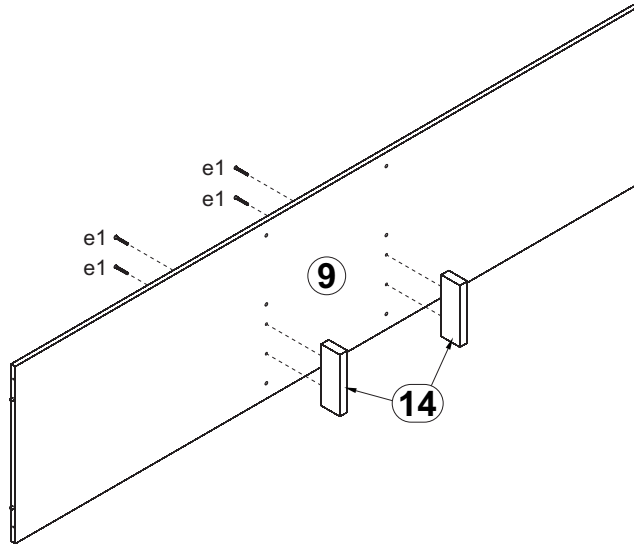

3

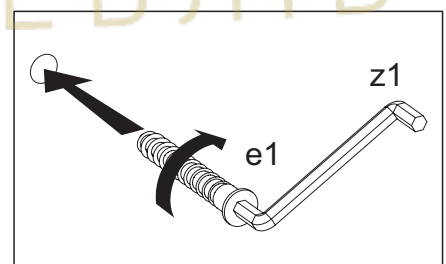

4

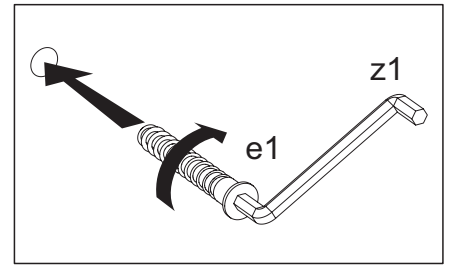
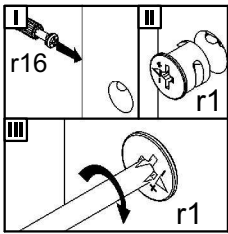
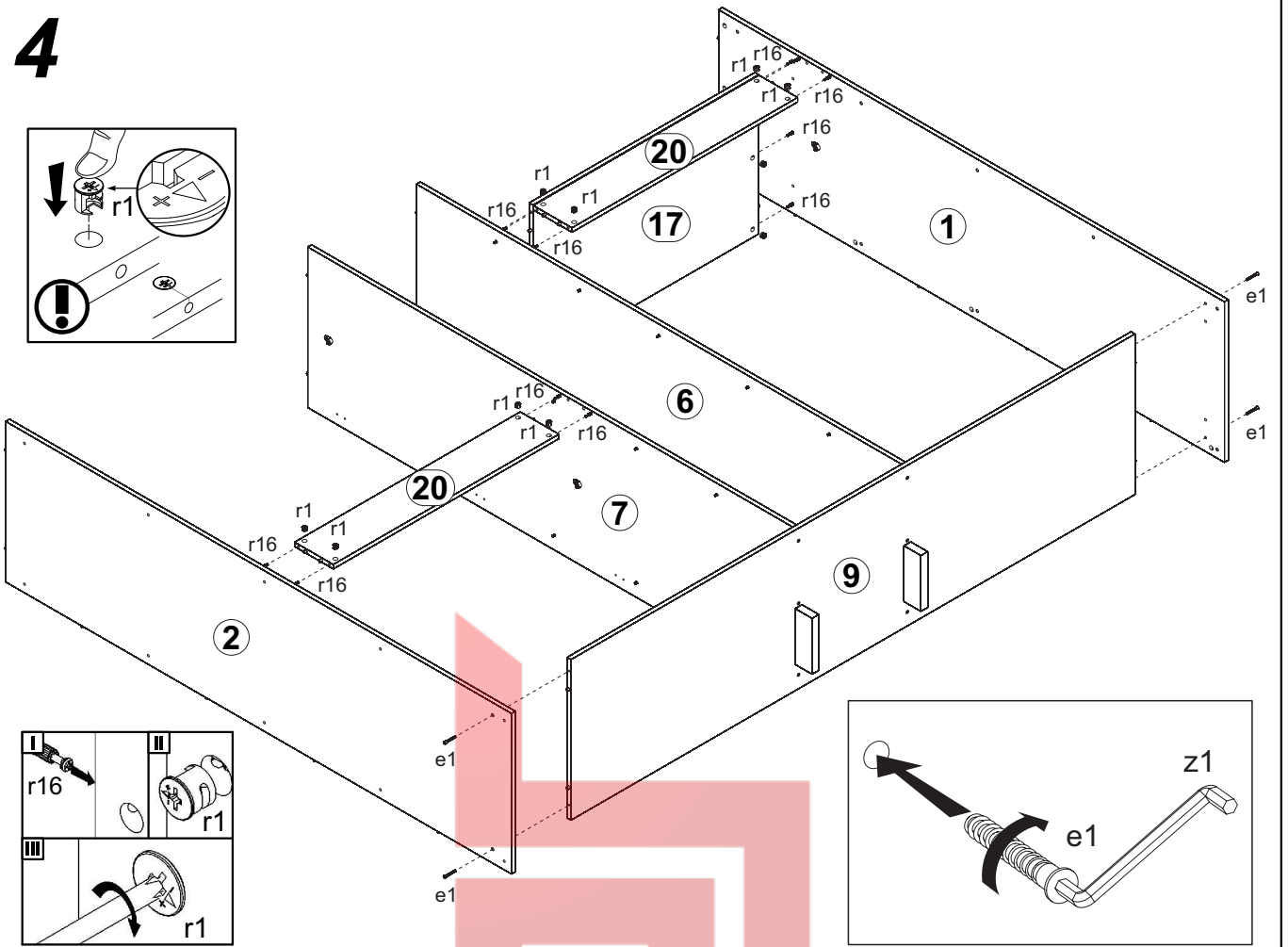
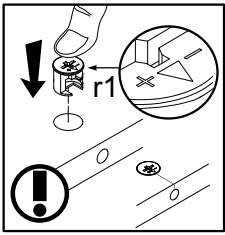

5

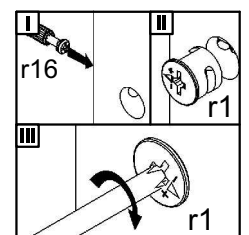
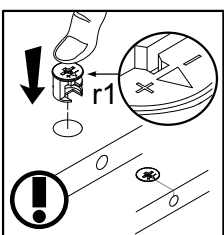
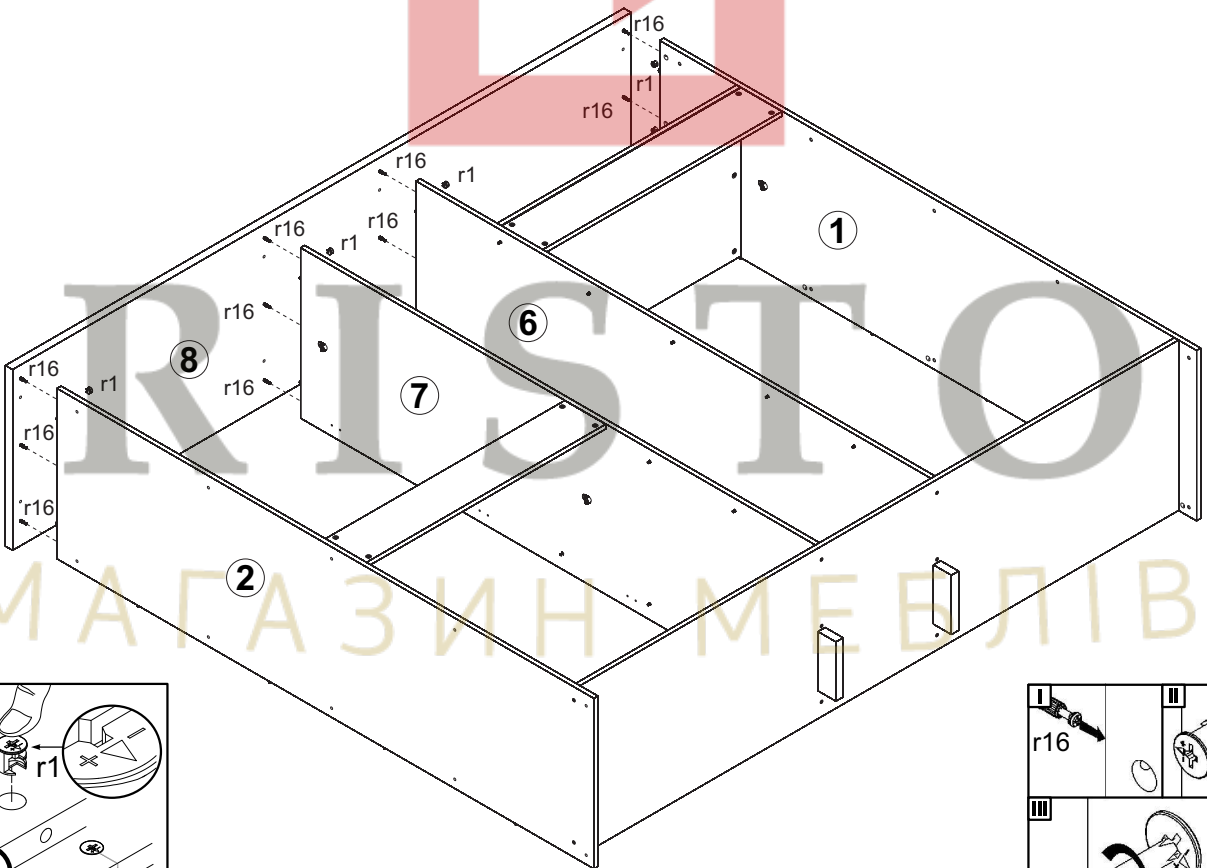

6

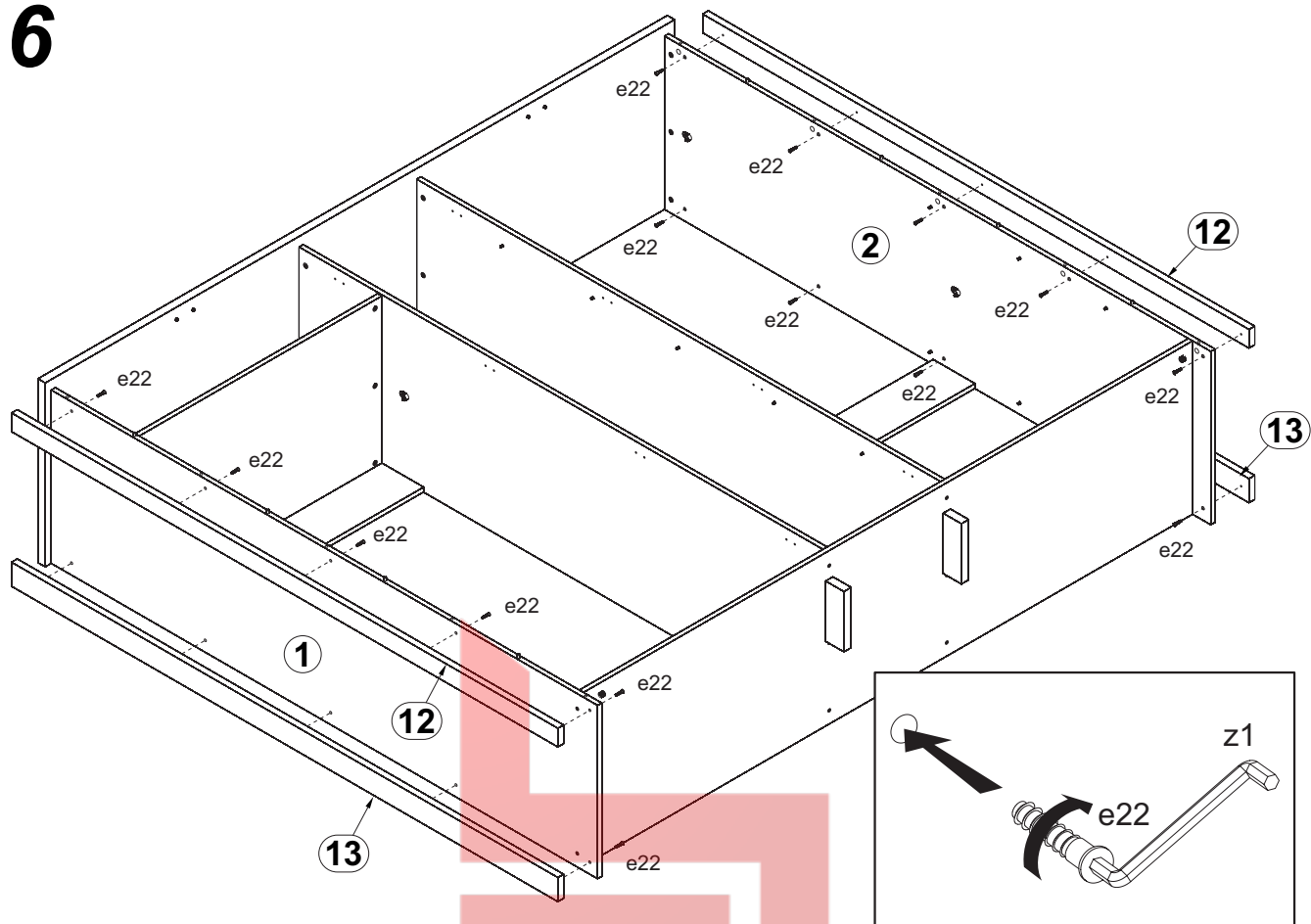

7

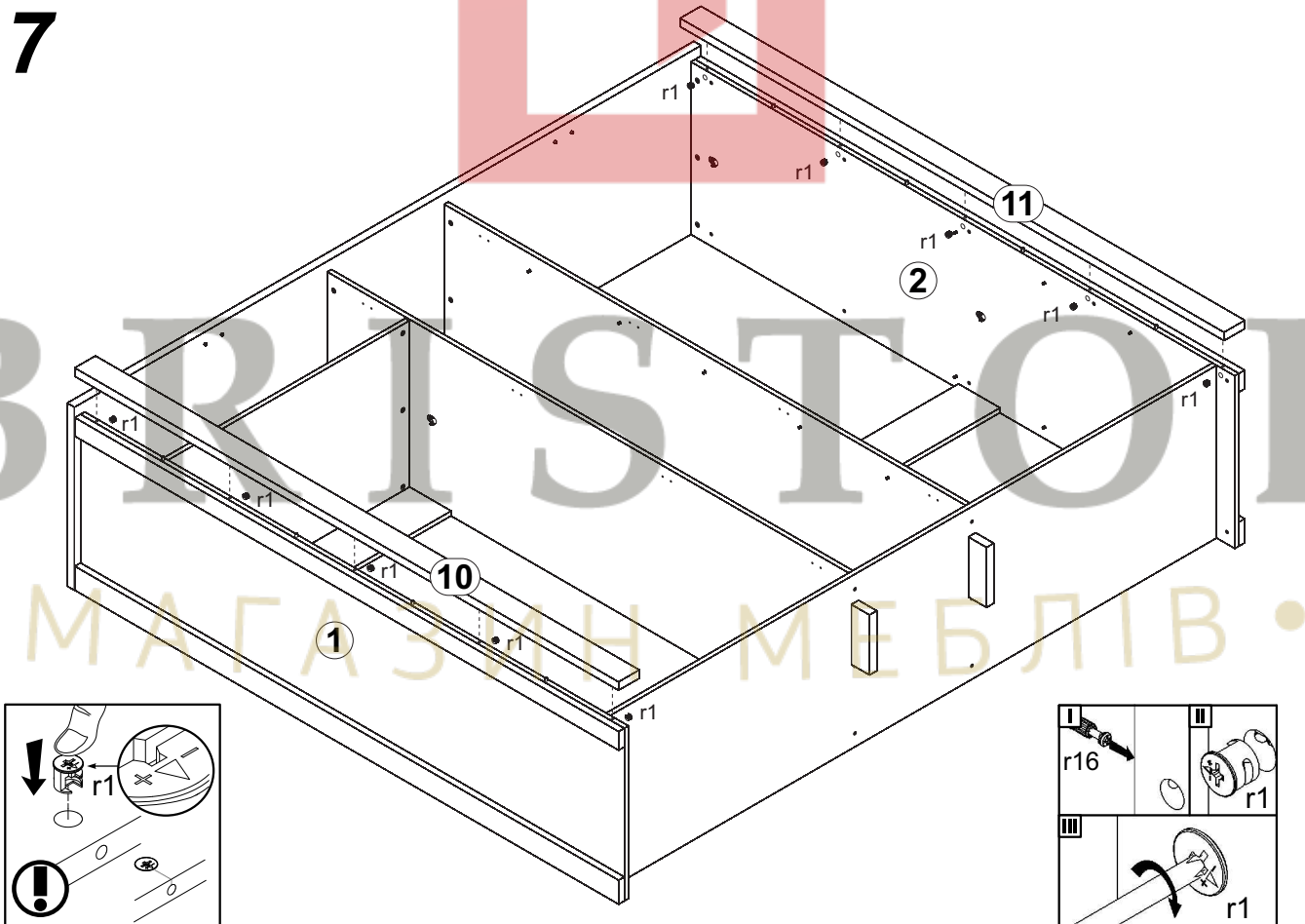

8

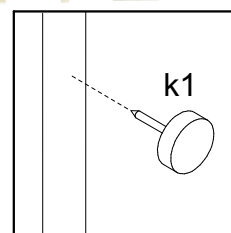
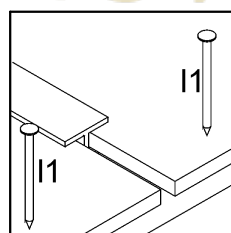
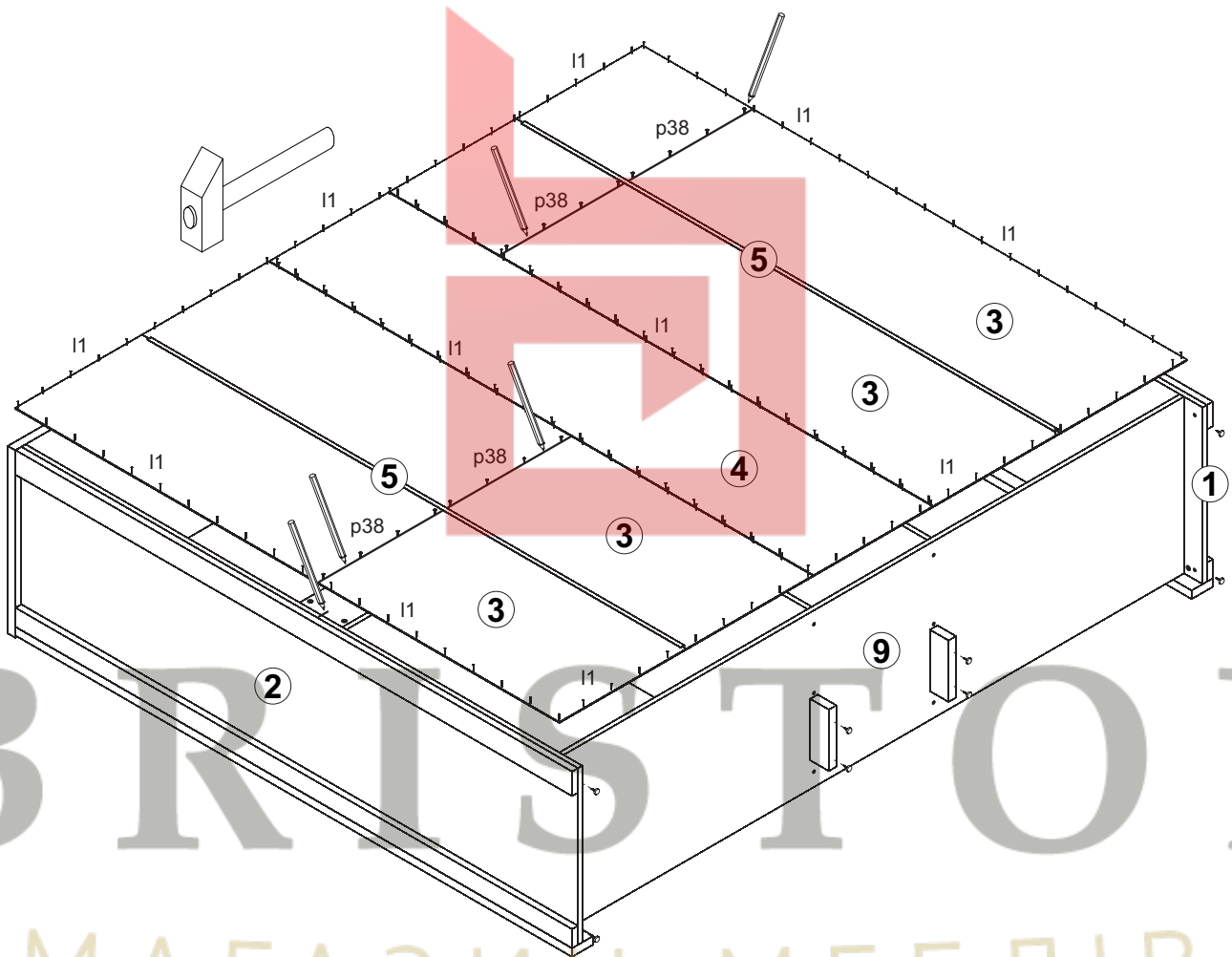
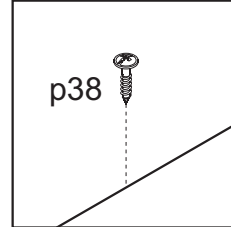
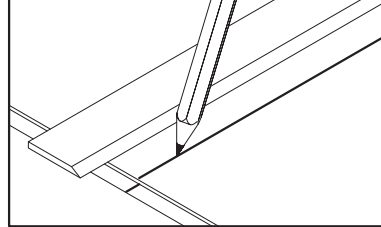
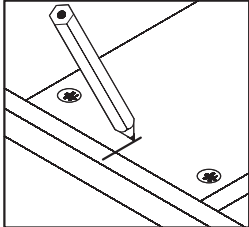
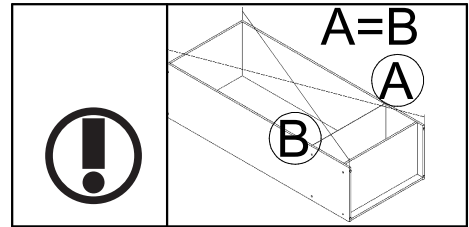

9

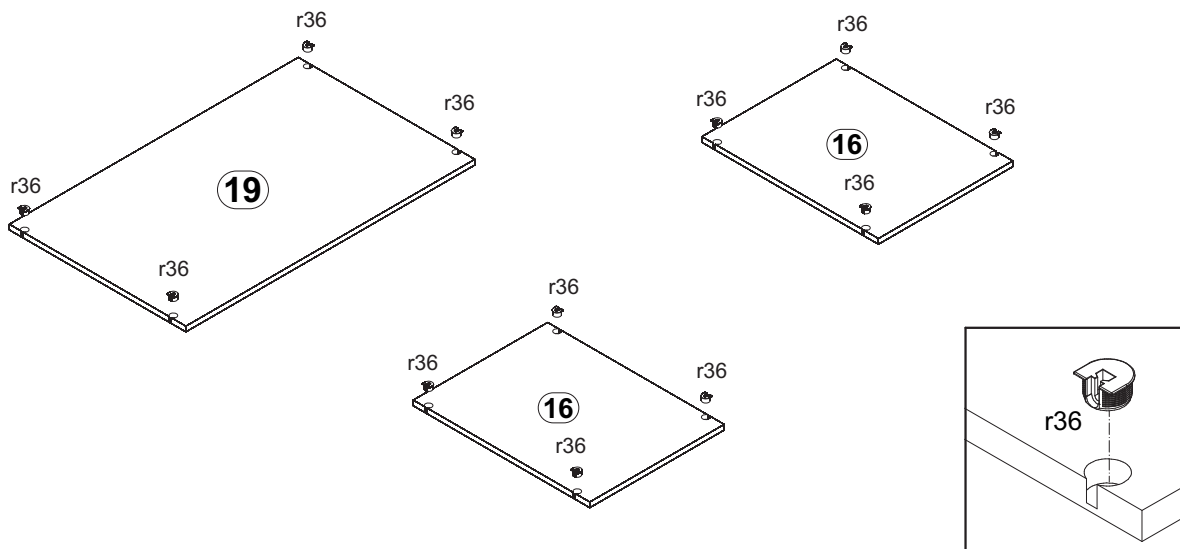

10

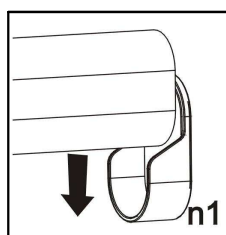
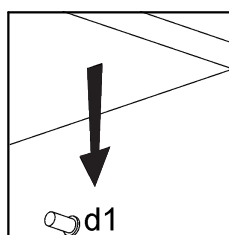
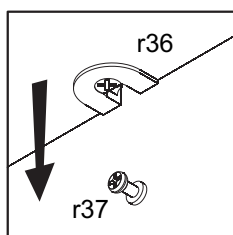
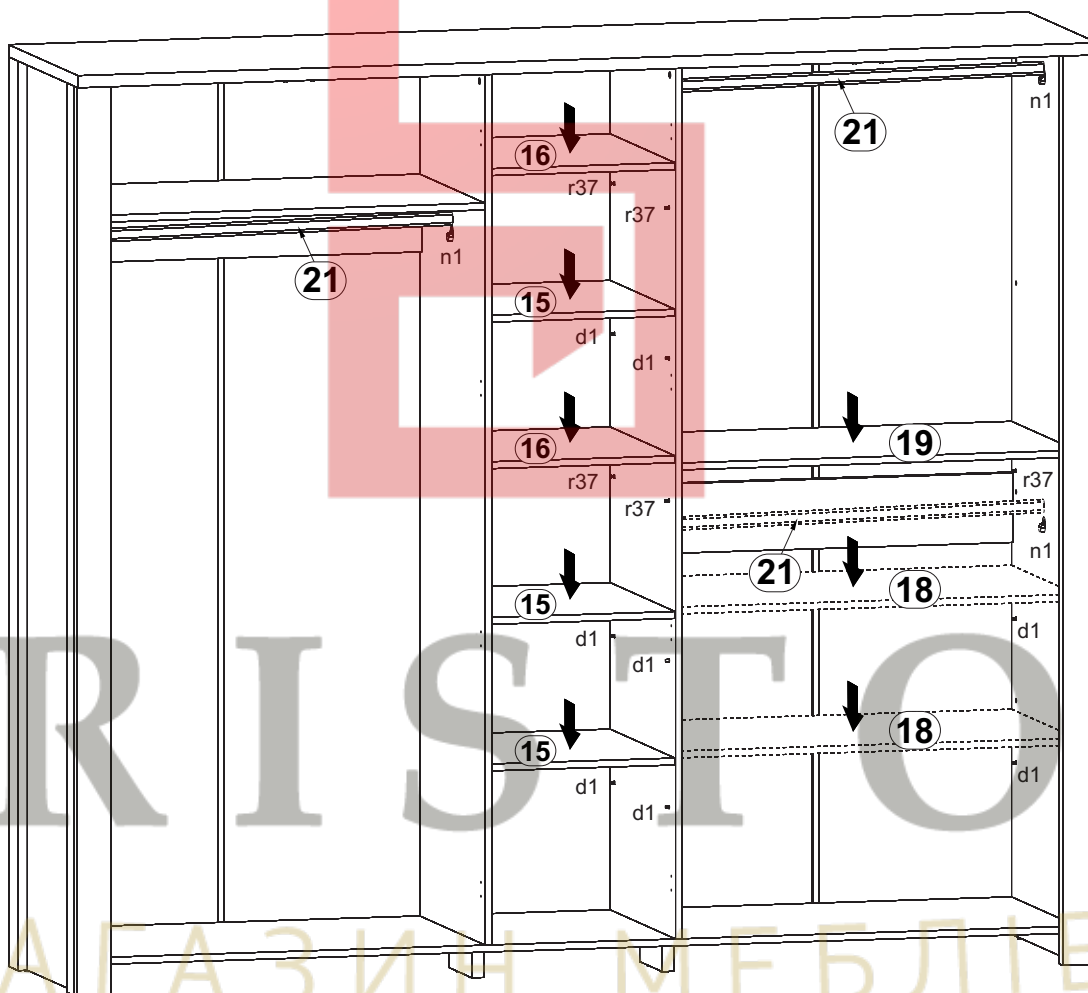

11

