

A	B	C	D
1	N61-115	200	200
2	N61-309	1400	201
3	N61-308	950	201
4	N61-423	927	200

A	B	C	D
1	N61-115	200	200
2	N61-309	1400	201
3	N61-308	950	201
4	N61-422	927	200

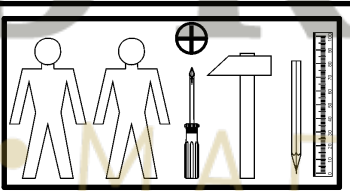
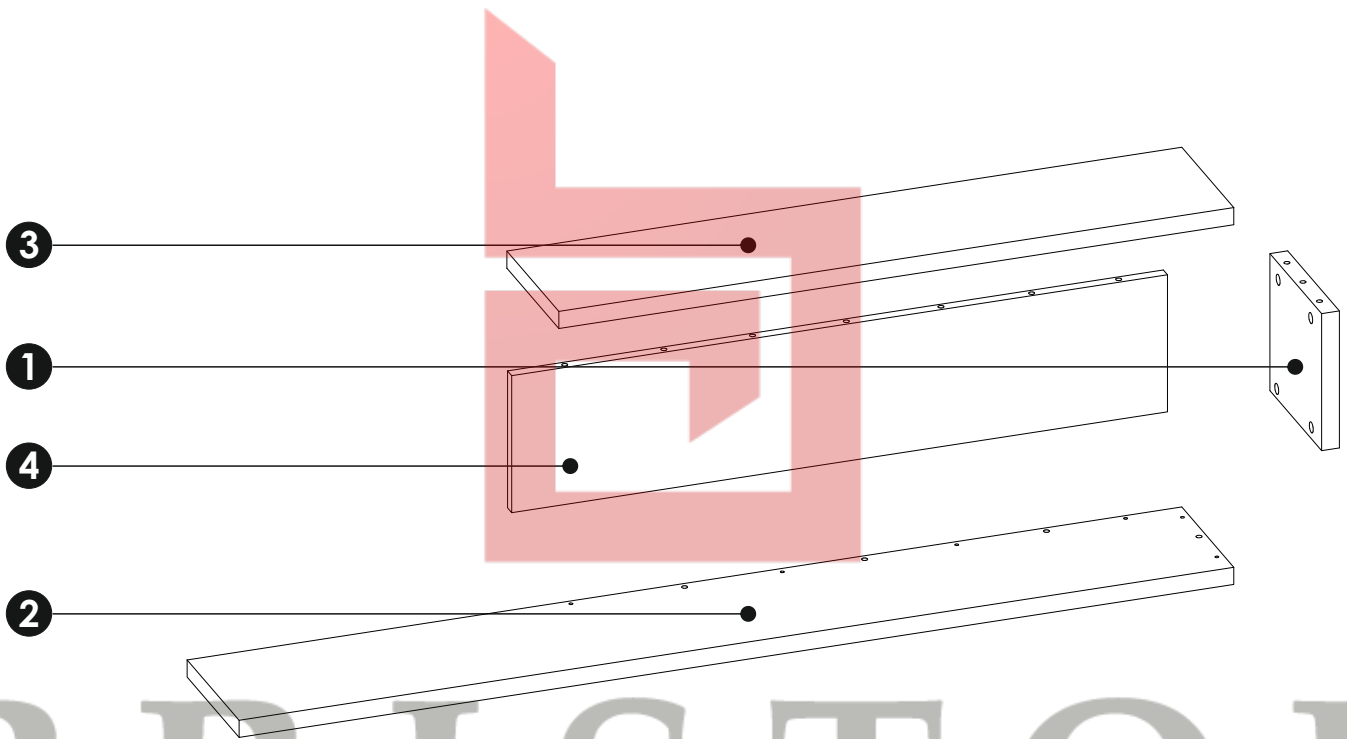

8x Ø15x12 mm #16 r1	4x Ø15x15 mm #22 r3	12x 20/11 r42	4x φ5x11 mm e4	2x g2	2x φ 6,3x13 mm e2	2x φ10x50 mm f35	2x φ5x60 mm p17	8x φ8x30 mm f1
4x Ø16 s2	2x siikon φ8x1,8mm o21							

1

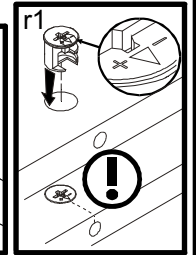
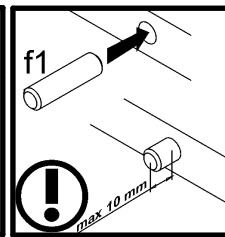
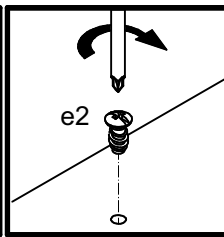
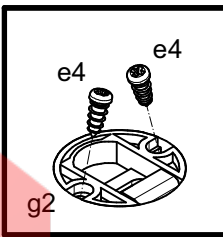
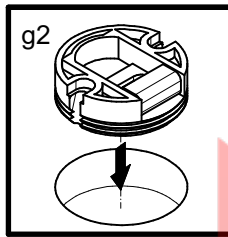
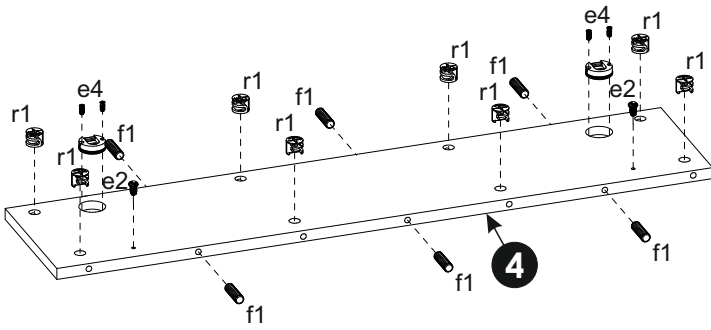

2

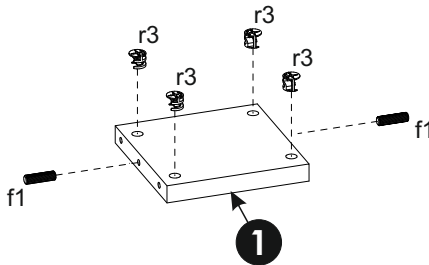

3

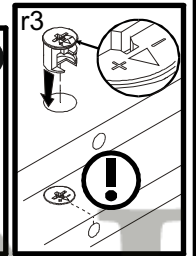
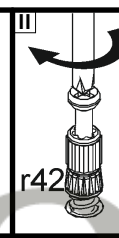
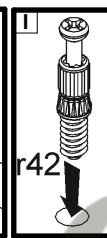
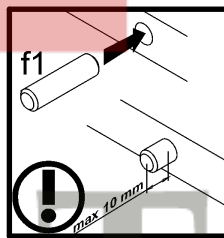
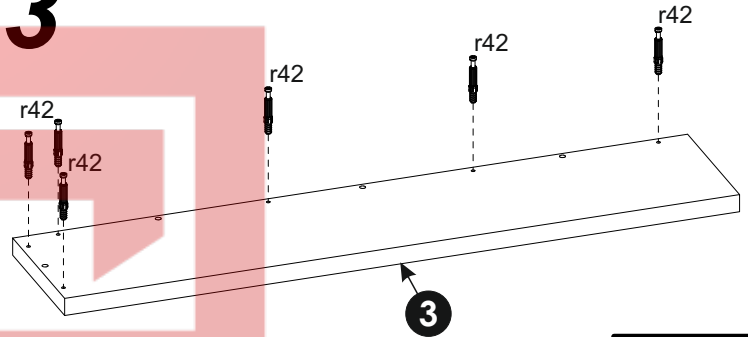

4

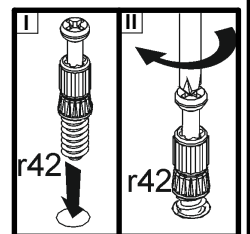
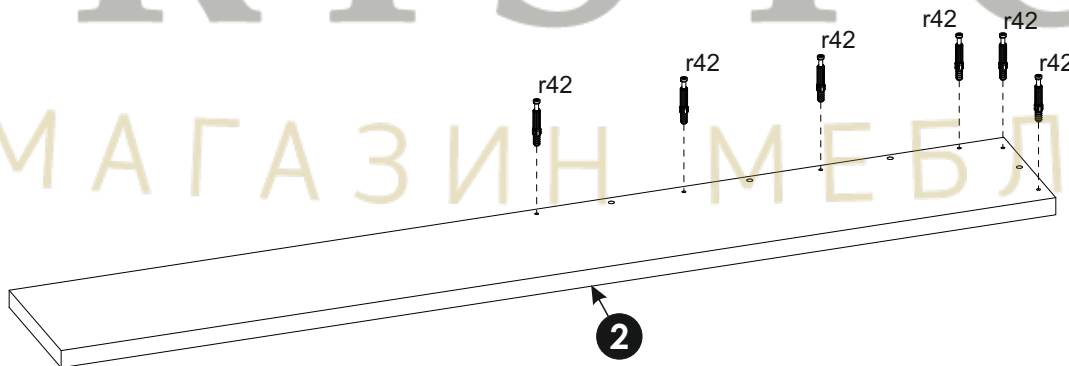

5



L

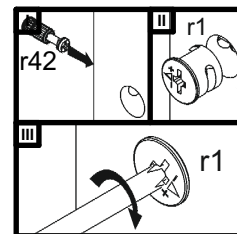
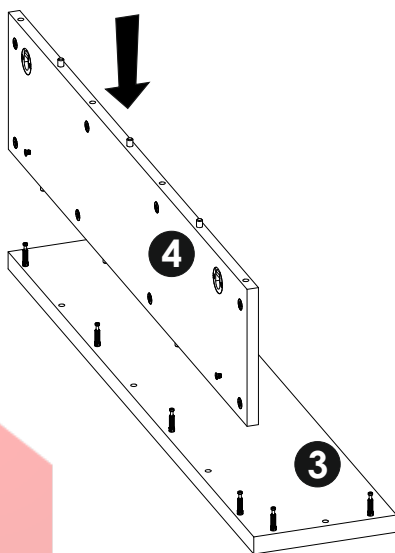
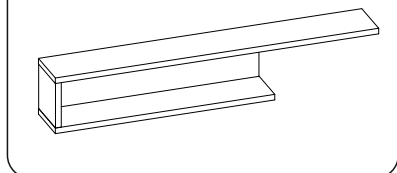

P

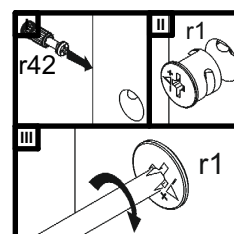
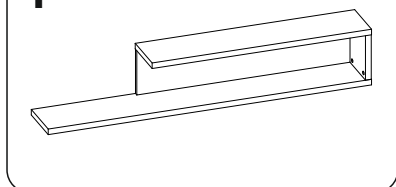

6



L

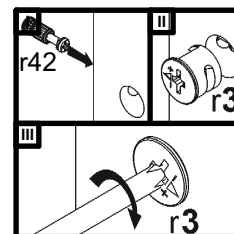
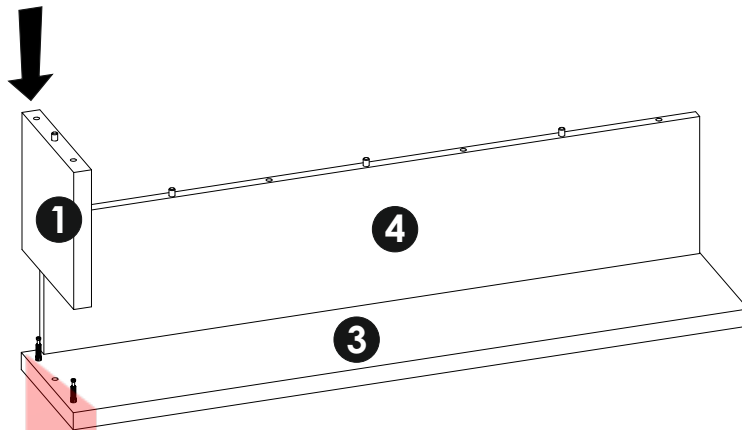
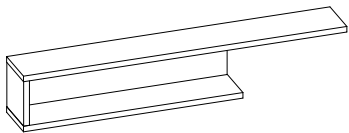

P

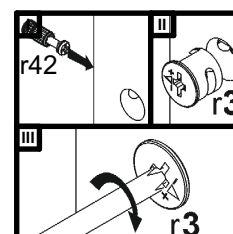
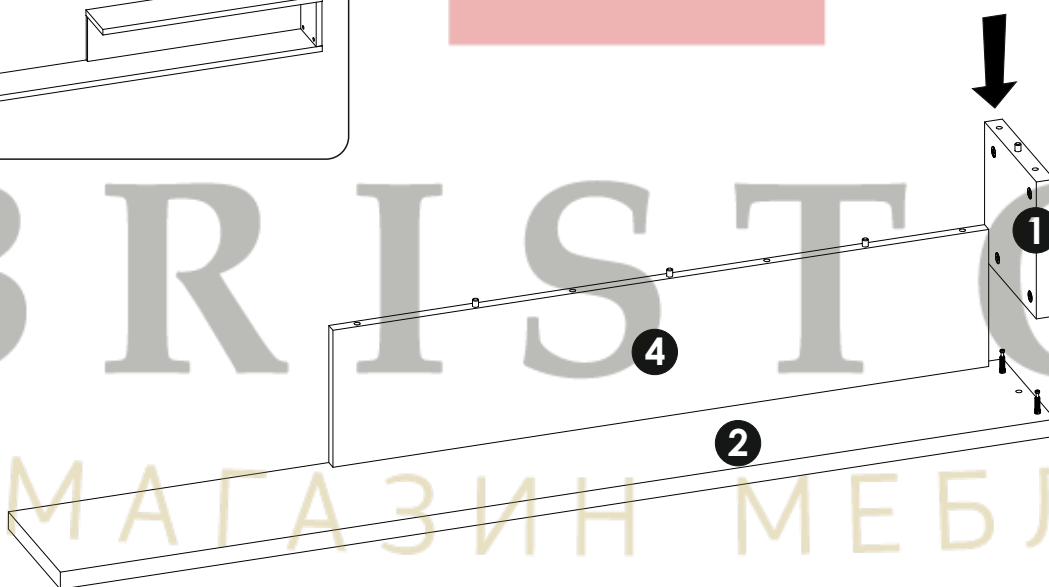
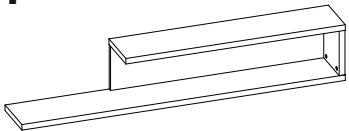

7

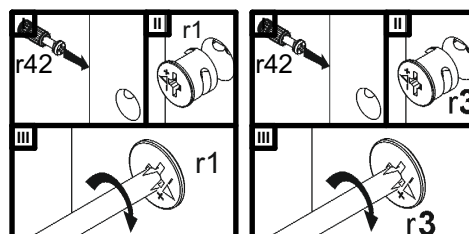
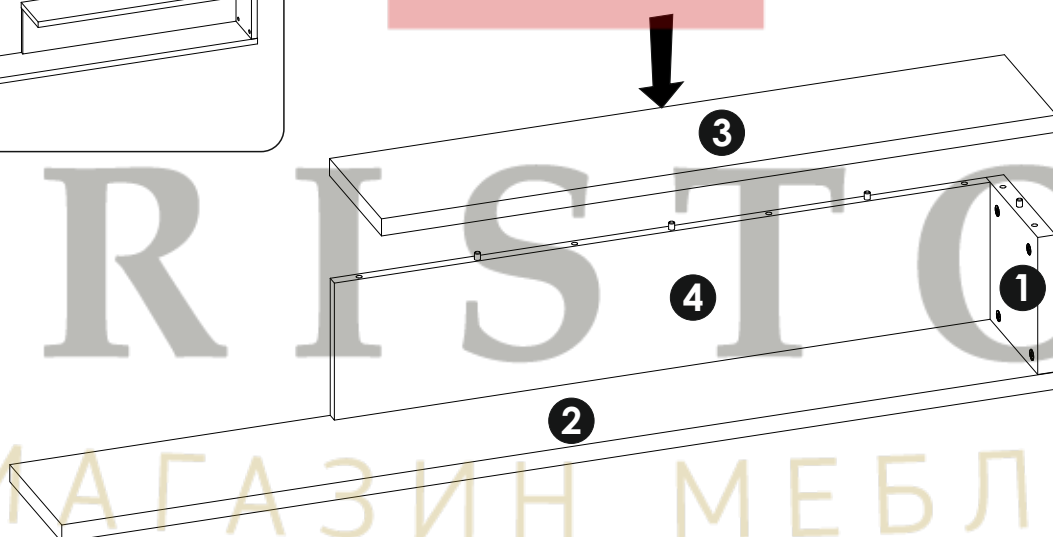
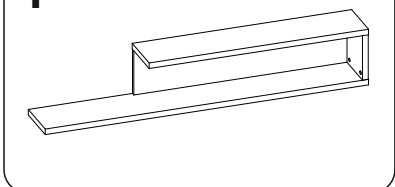
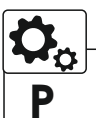
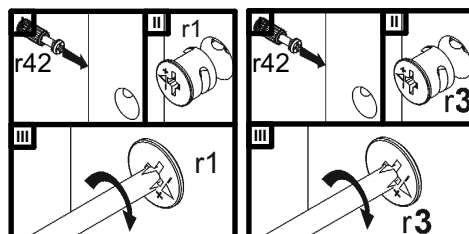
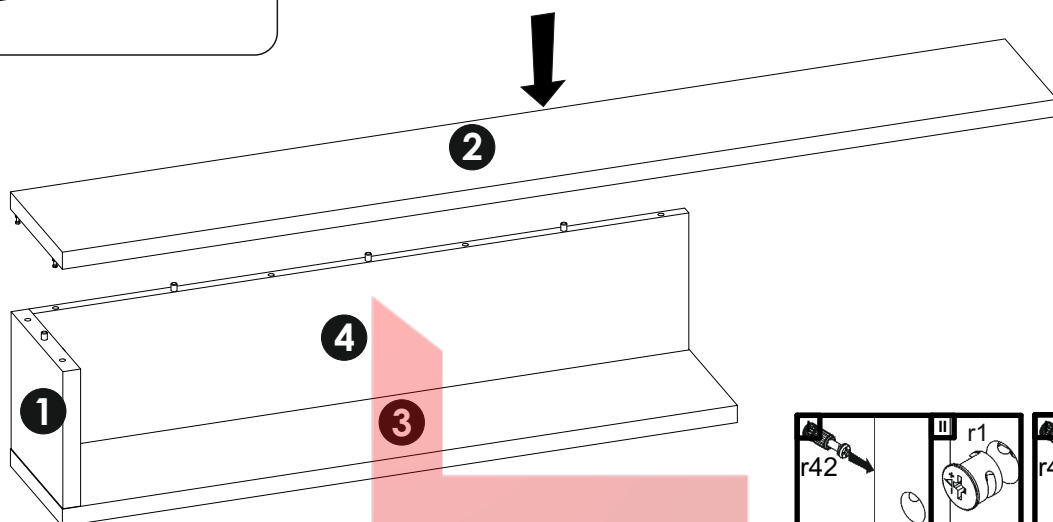
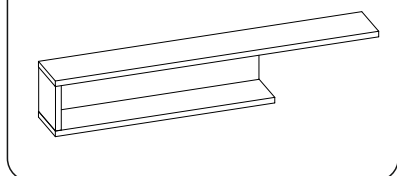
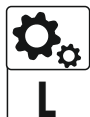

8

