

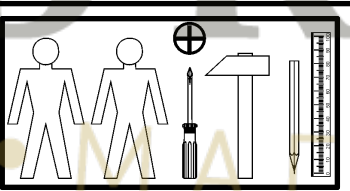

A	B	C	D	
1	N61-103	1614	404	1/2
2	N61-201	581	404	1/2
3	N61-202	565	404	1/2
4	N61-203	581	404	1/2
5	N61-402	372	100	1/2
6	N61-501	404	60	1/2
7	N61-502	598	60	1/2
8	N61-503	372	100	1/2
9	N61-506	379	380	1/2
10	N61-516	1414	125	1/2
11	N61-517	1571	60	1/2
12	N61-518	435	380	1/2
13	N61-701	422	404	1/2
14	N61-703	660	404	1/2
15	N61-301	565	356	2/2
16	N61-302	565	355	2/2
17	N61-401	565	100	2/2
18	N61-403	549	100	2/2
19	N61-409	1382	565	2/2
20	N61-504	549	100	2/2
21	N61-704	485	422	2/2
22	N61-706	485	676	2/2

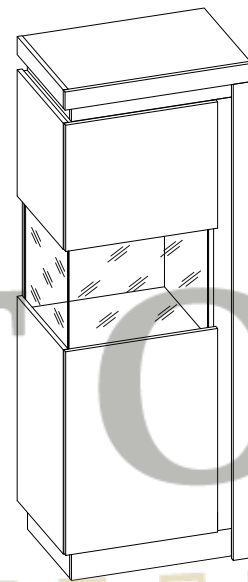
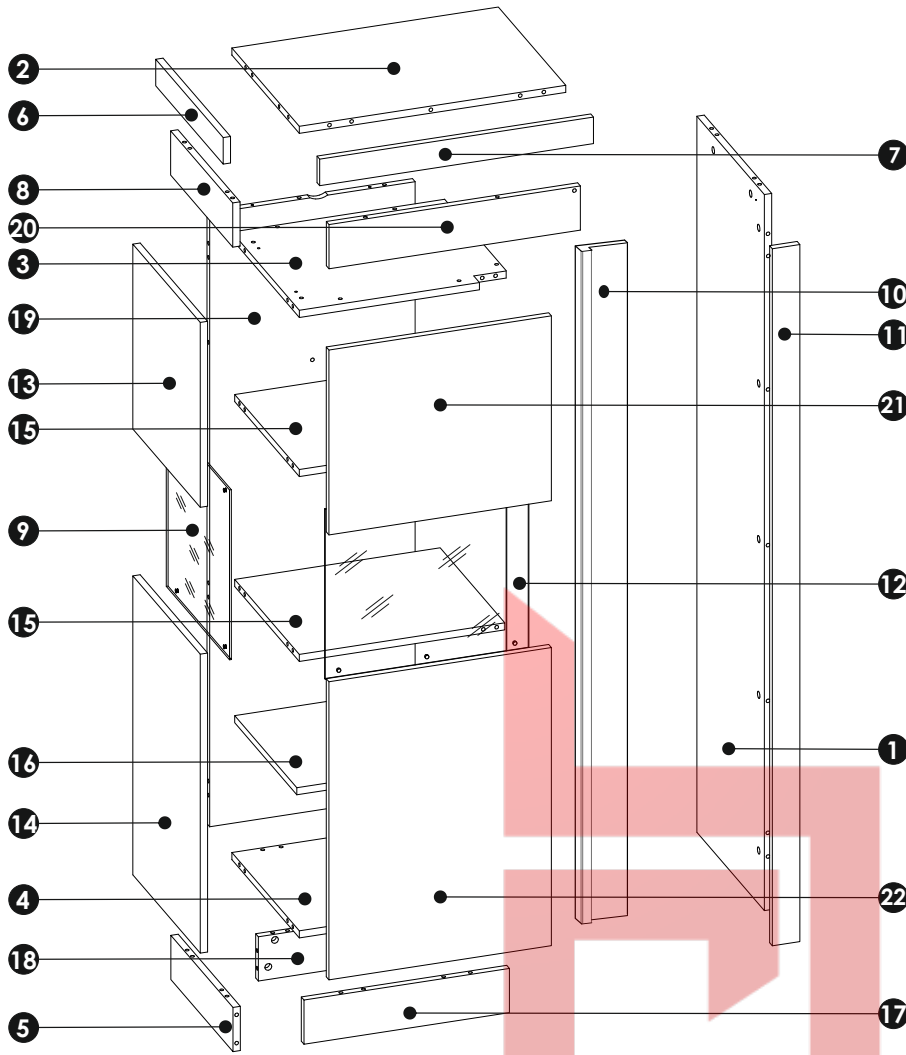

4x a44	4x b19	8x e1 Ø7x50 mm	12x e41 φ5x12 mm	12x o54 φ5,3/φ8,3x4,8mm	8x p51 Ø3,5x15 mm	59x f1 Ø8x30 mm	4x k1	4x d1 Ø5x17 mm
59x r1 Ø15x12 mm #16	59x r42 20/11	10x r15 φ12x10,5mm #12	10x r37 6,7/7,8	1x f35 φ10x50 mm	1x p17 φ5x60 mm	1x n14 81x21x15/1,5mm	2x p38 Ø3,5x16 mm	2x o21 silikon
1x o60/1	1x o60/2	1x o83 L=950 mm	1x o83 L=1550 mm	1x o43/6.3				
						15x s2 Ø16	1x z1 4 mm	

1

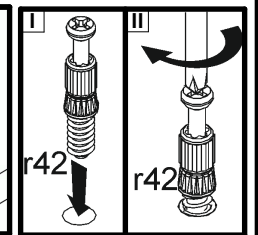
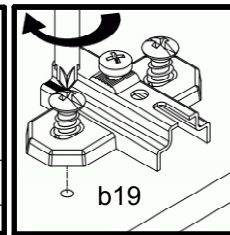
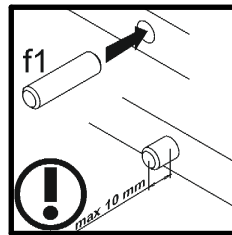
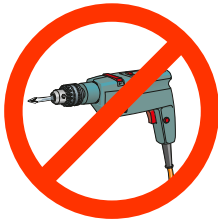
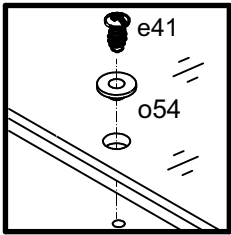
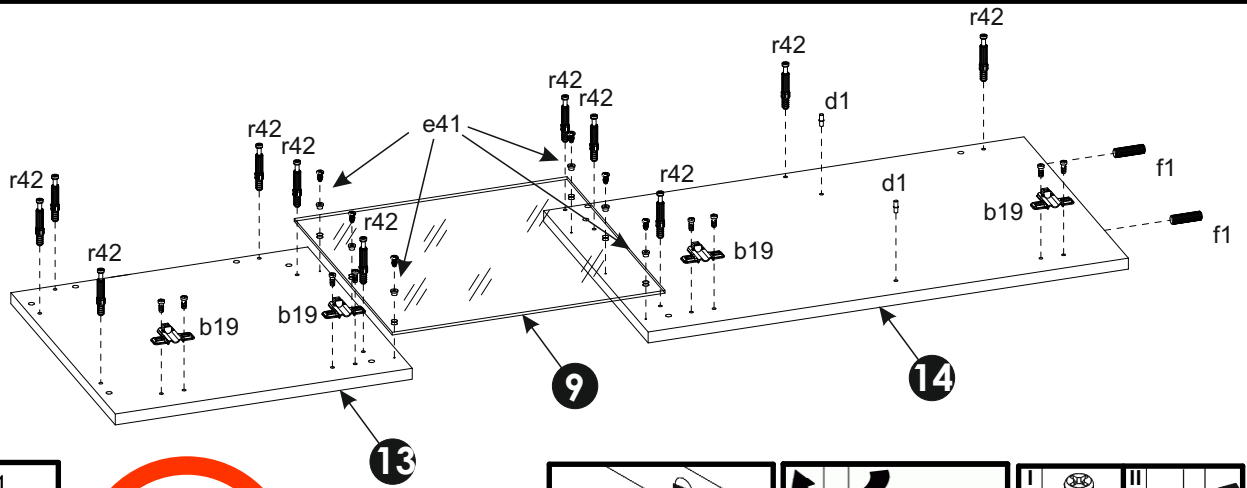

2

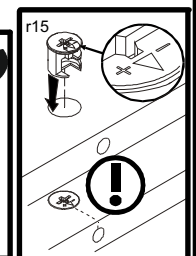
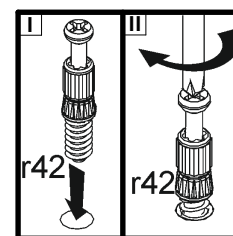
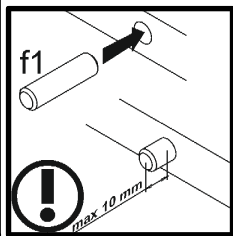
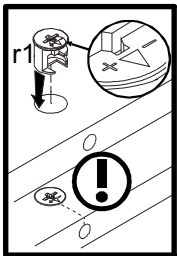
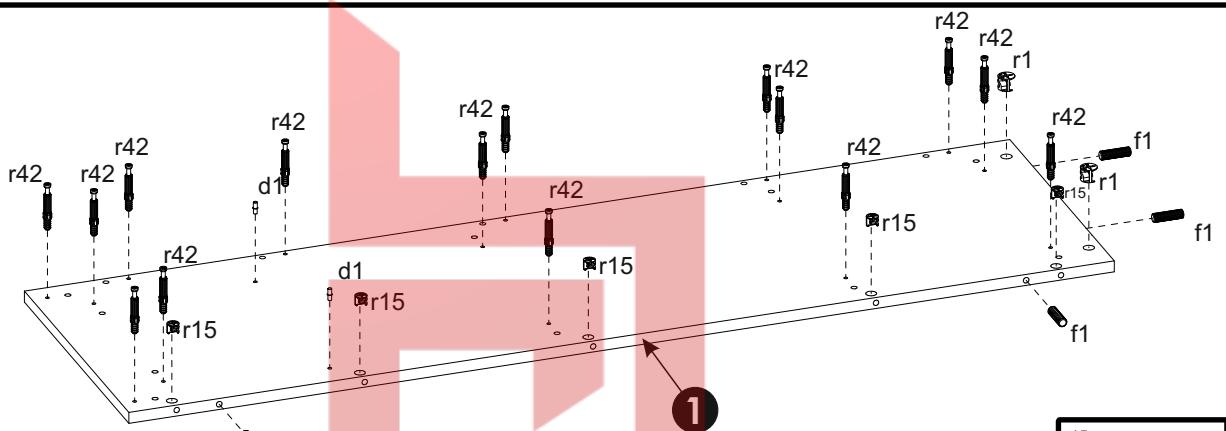

3

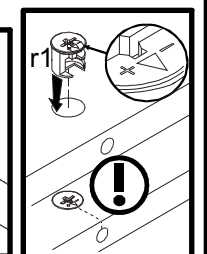
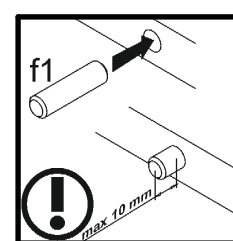
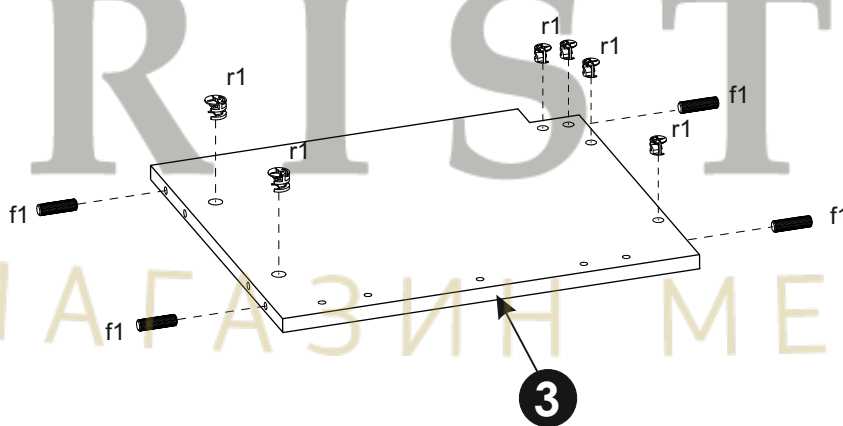

4

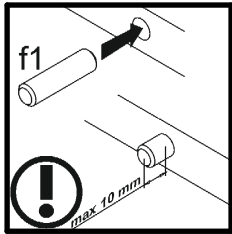
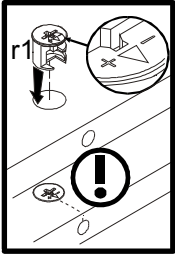
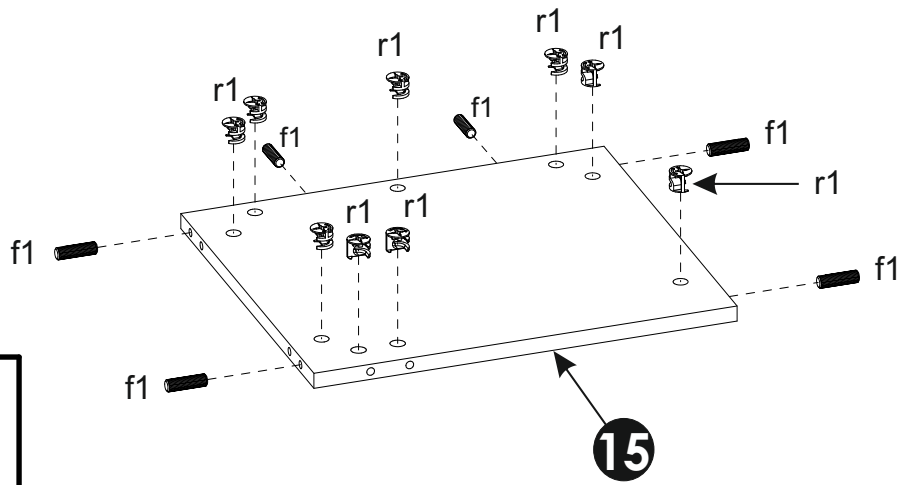

5

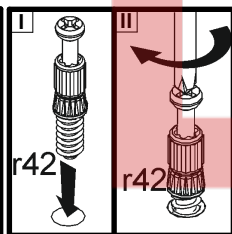
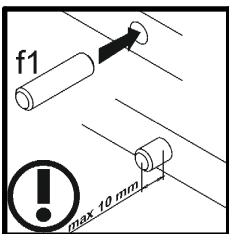
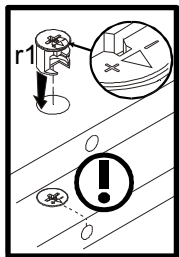
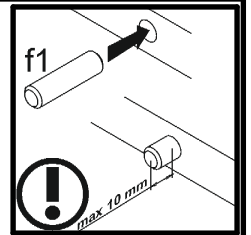
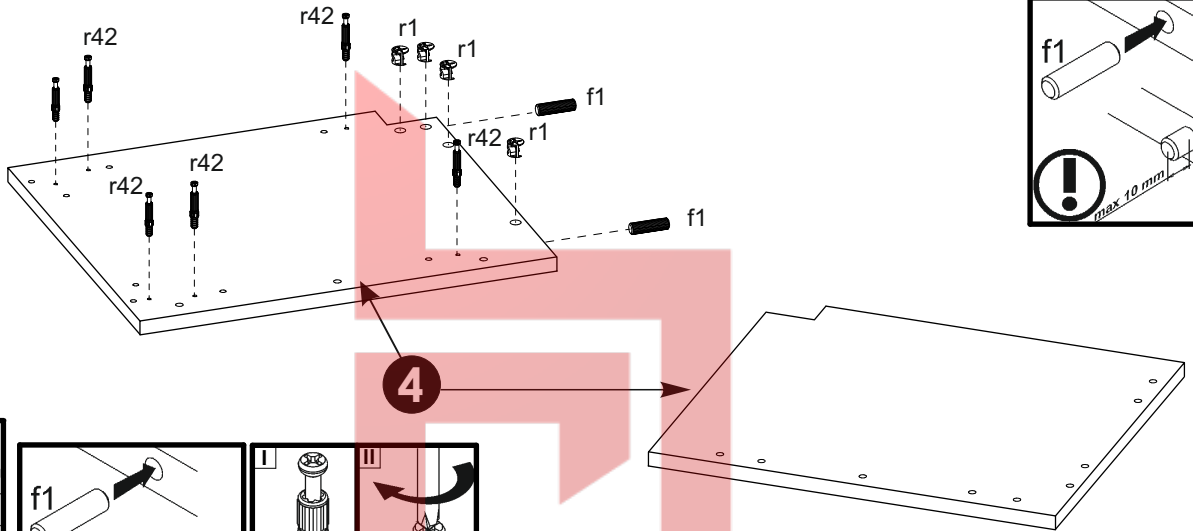

6

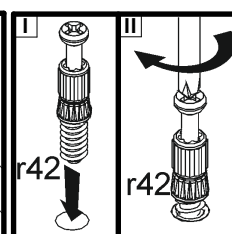
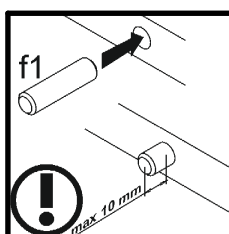
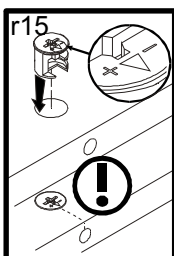
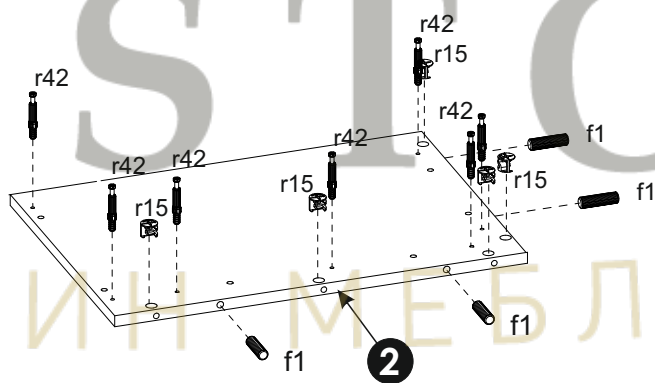

7

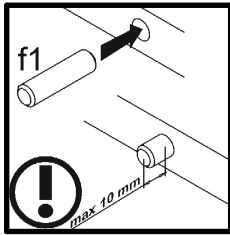
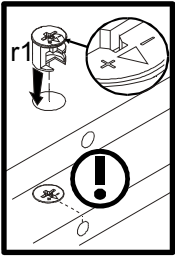
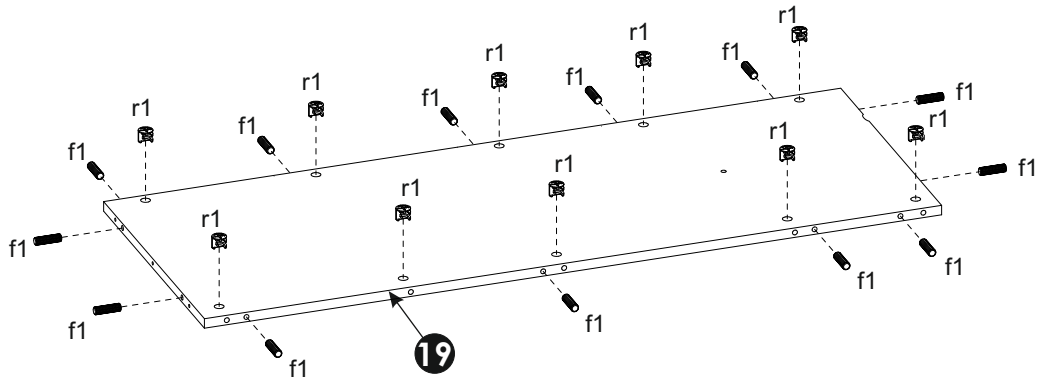

8

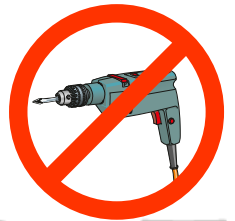
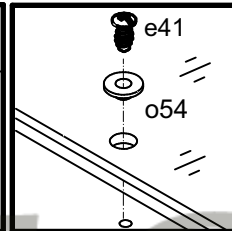
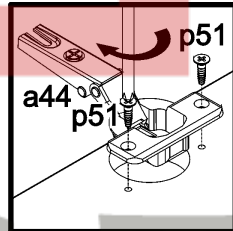
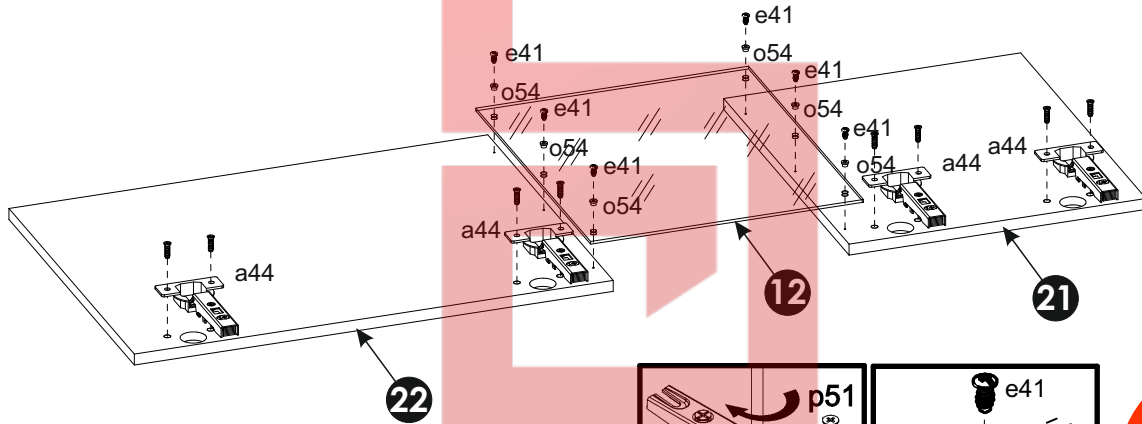

9

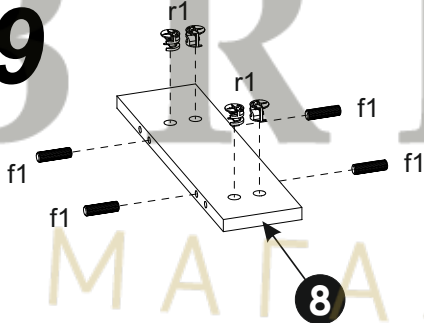

10

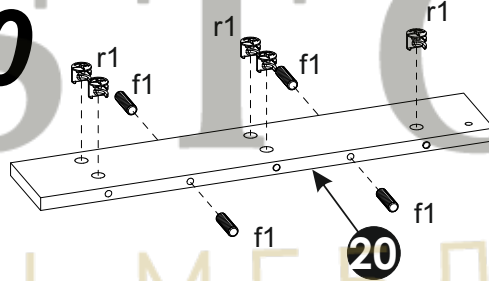

11

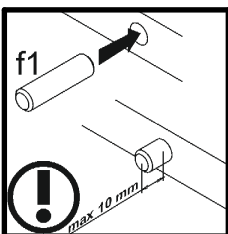
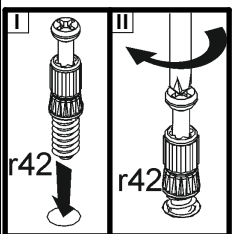
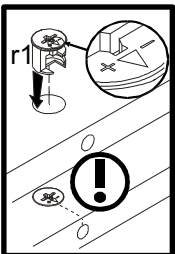
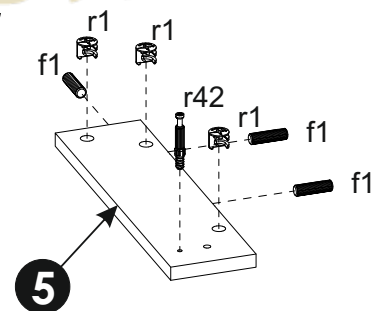

12

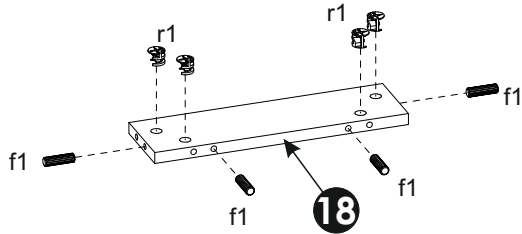

13

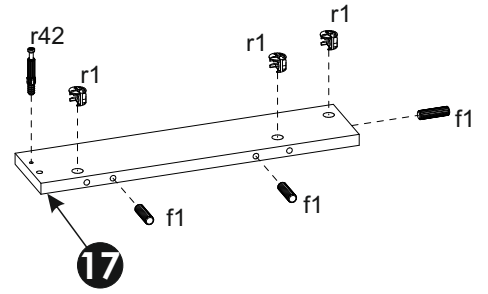

14

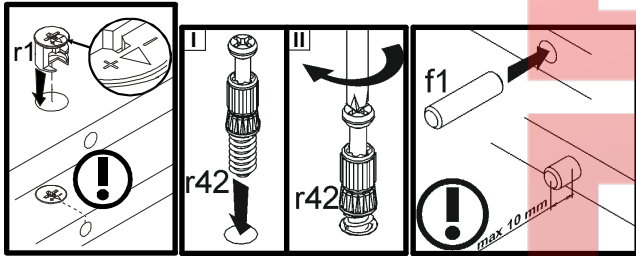
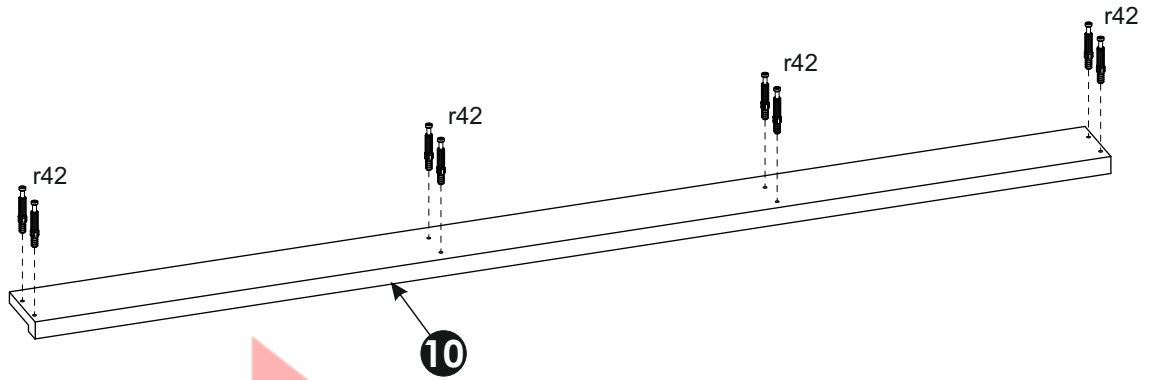

15

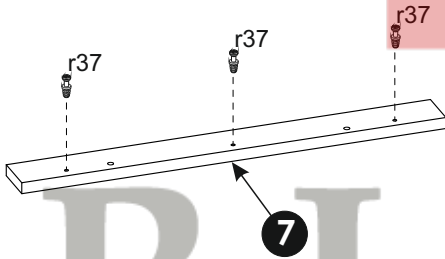

16

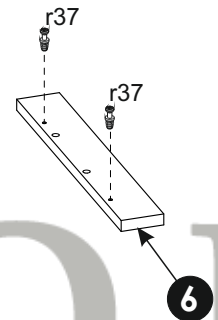

17

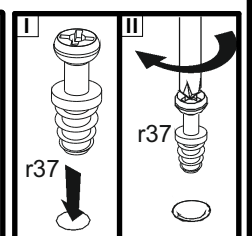
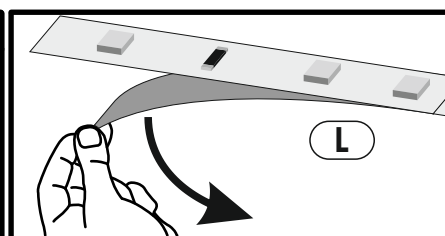
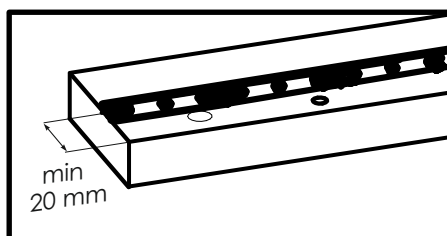
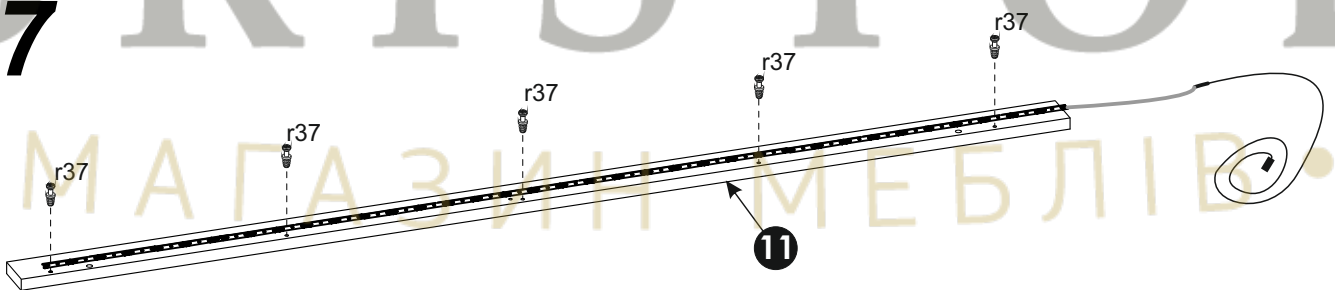

18

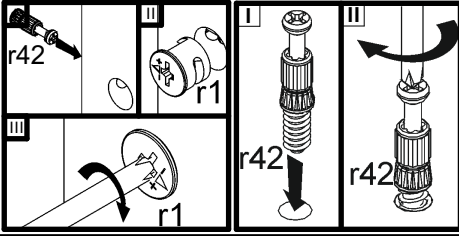
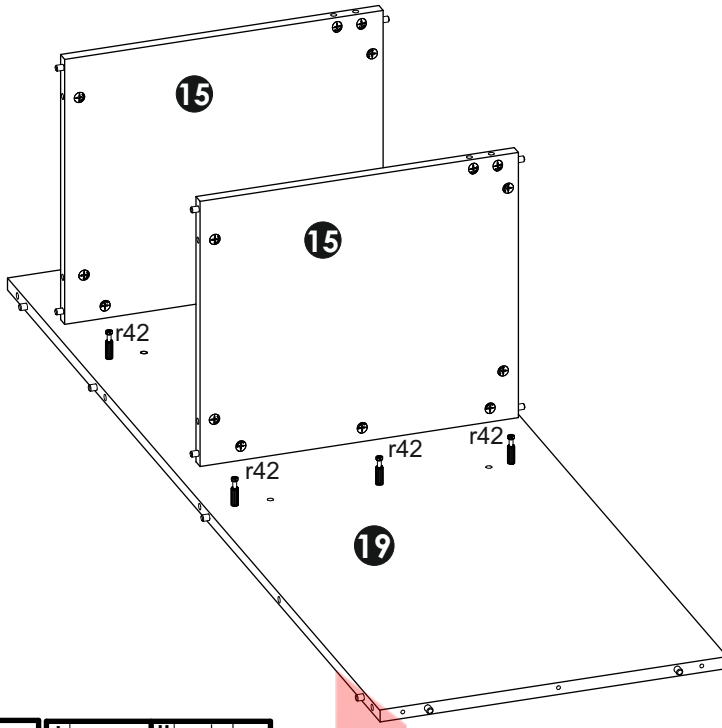

19

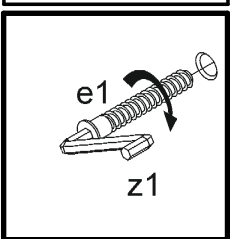
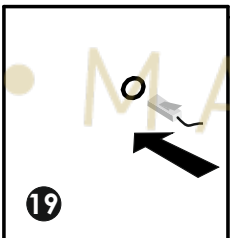
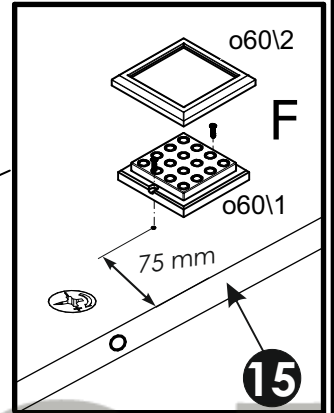
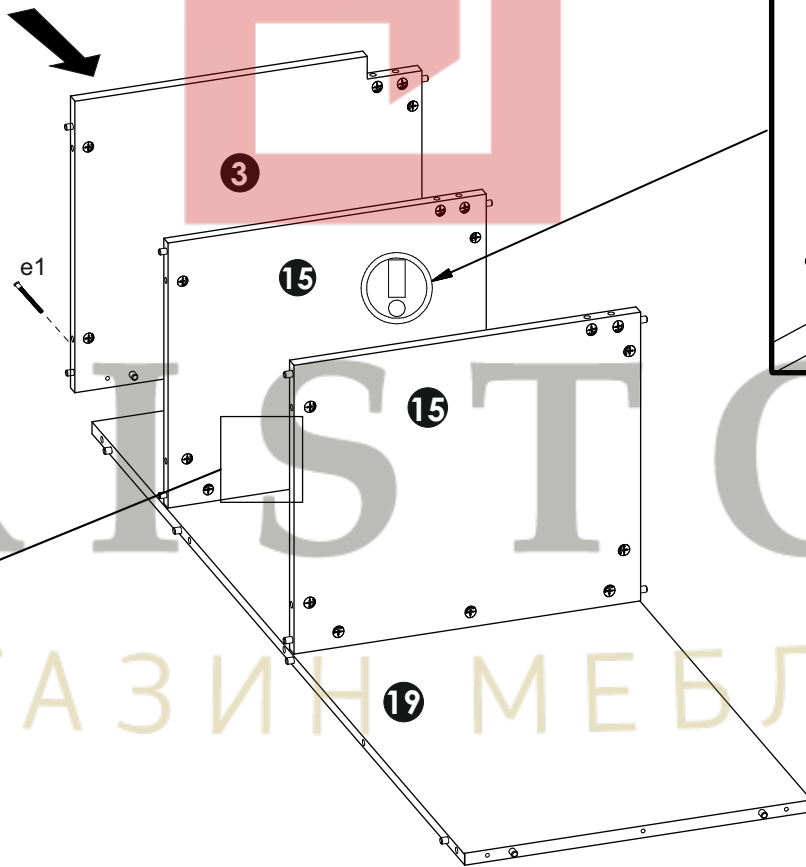

20

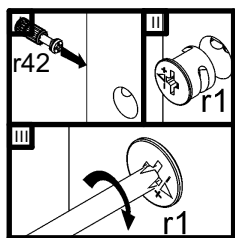
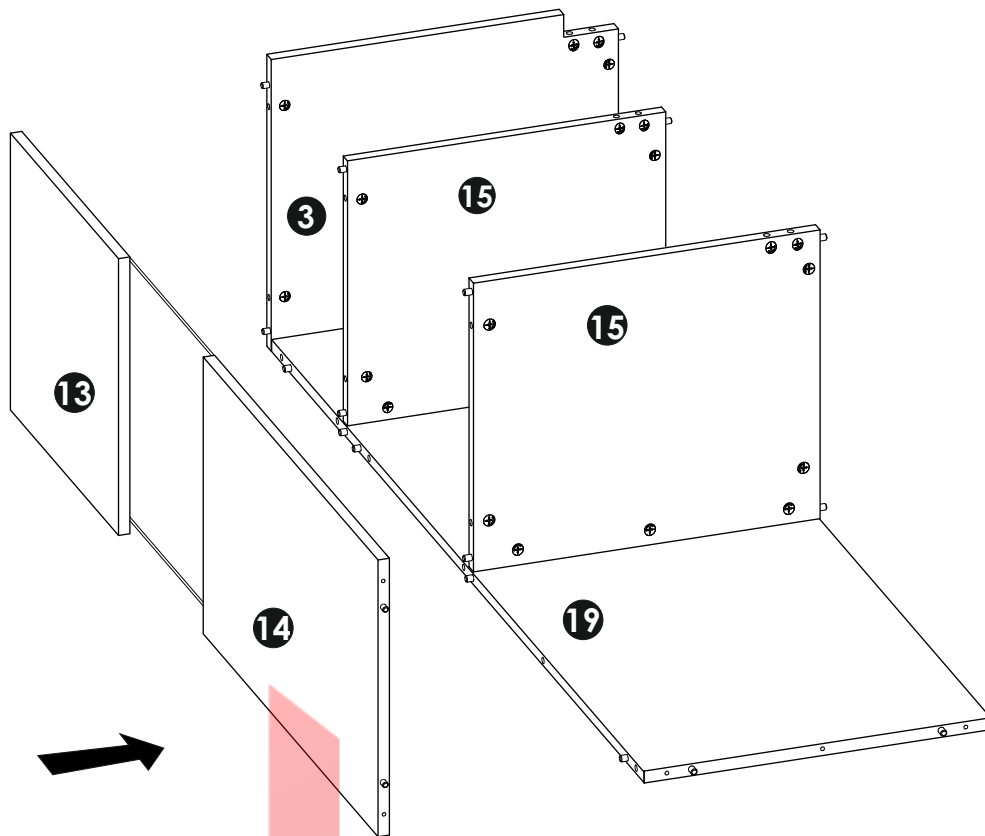

21

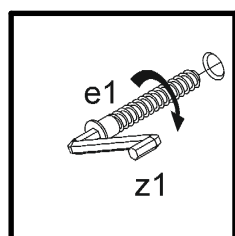
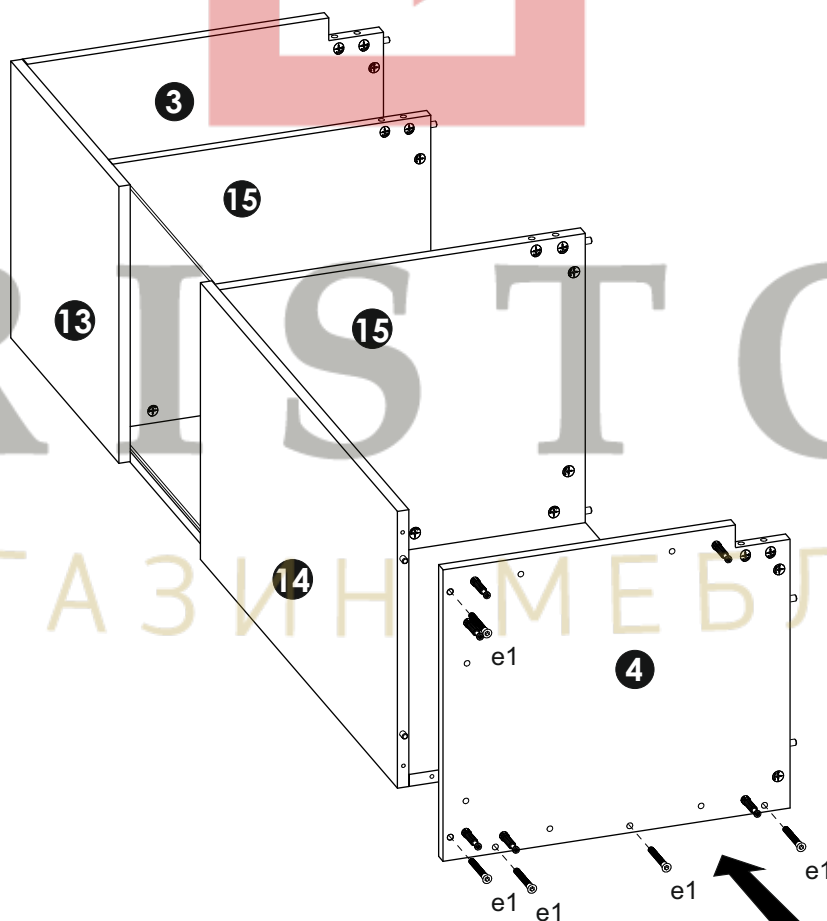

22

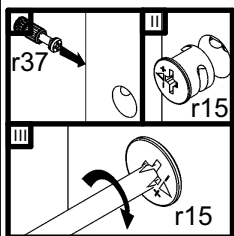
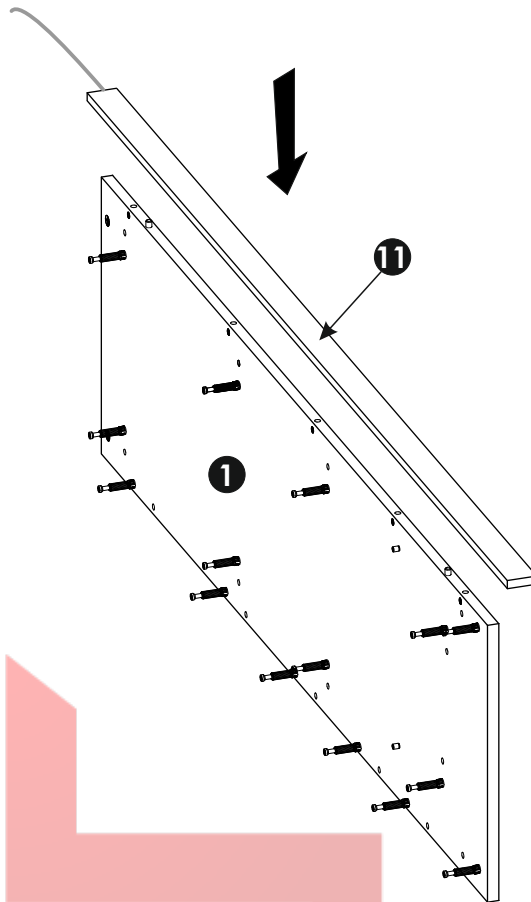

25

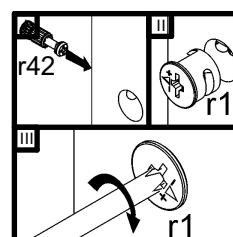
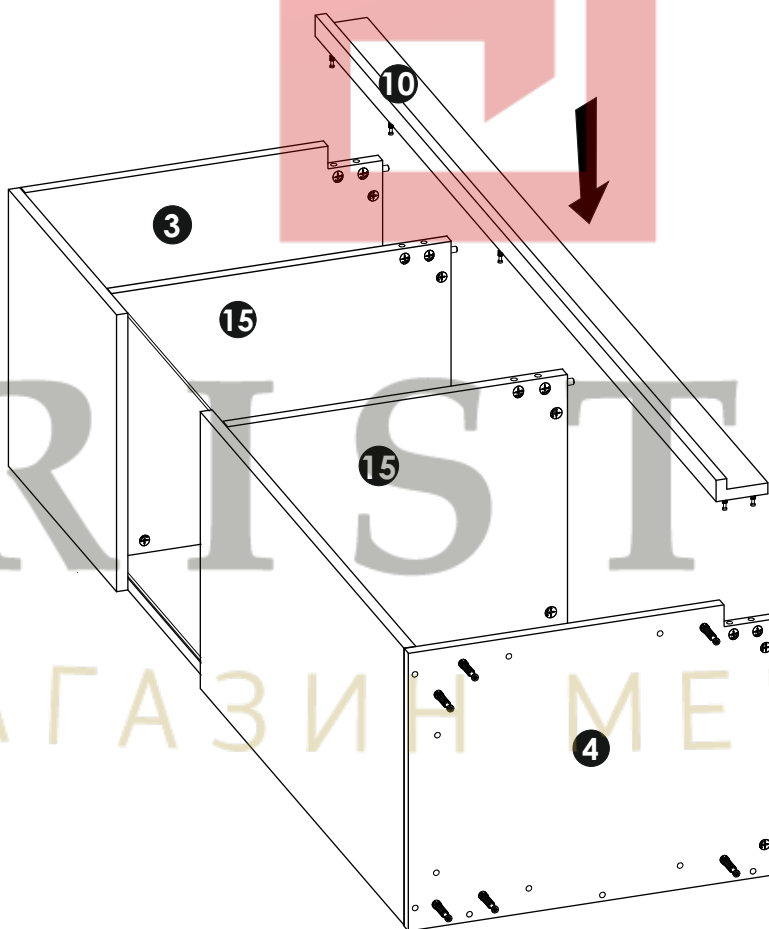

24

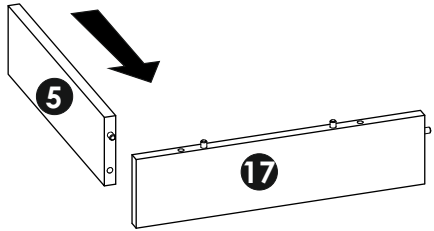

25

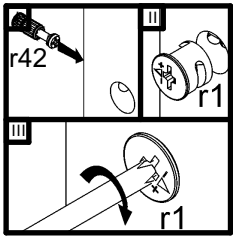
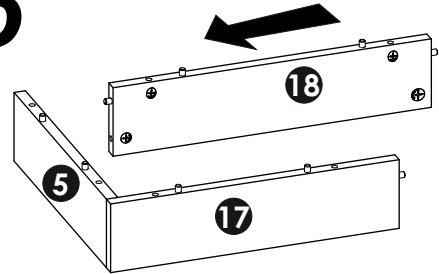

26

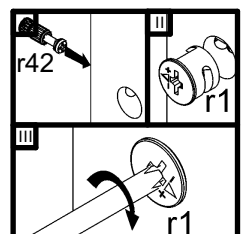
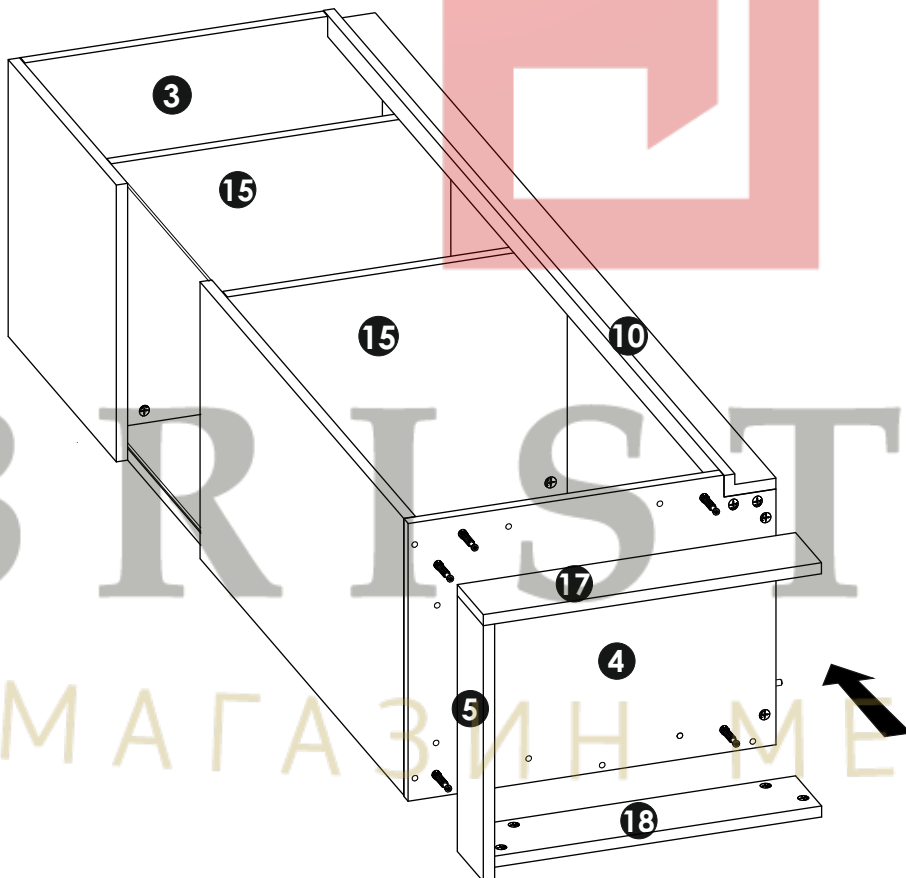

27

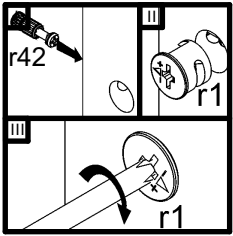
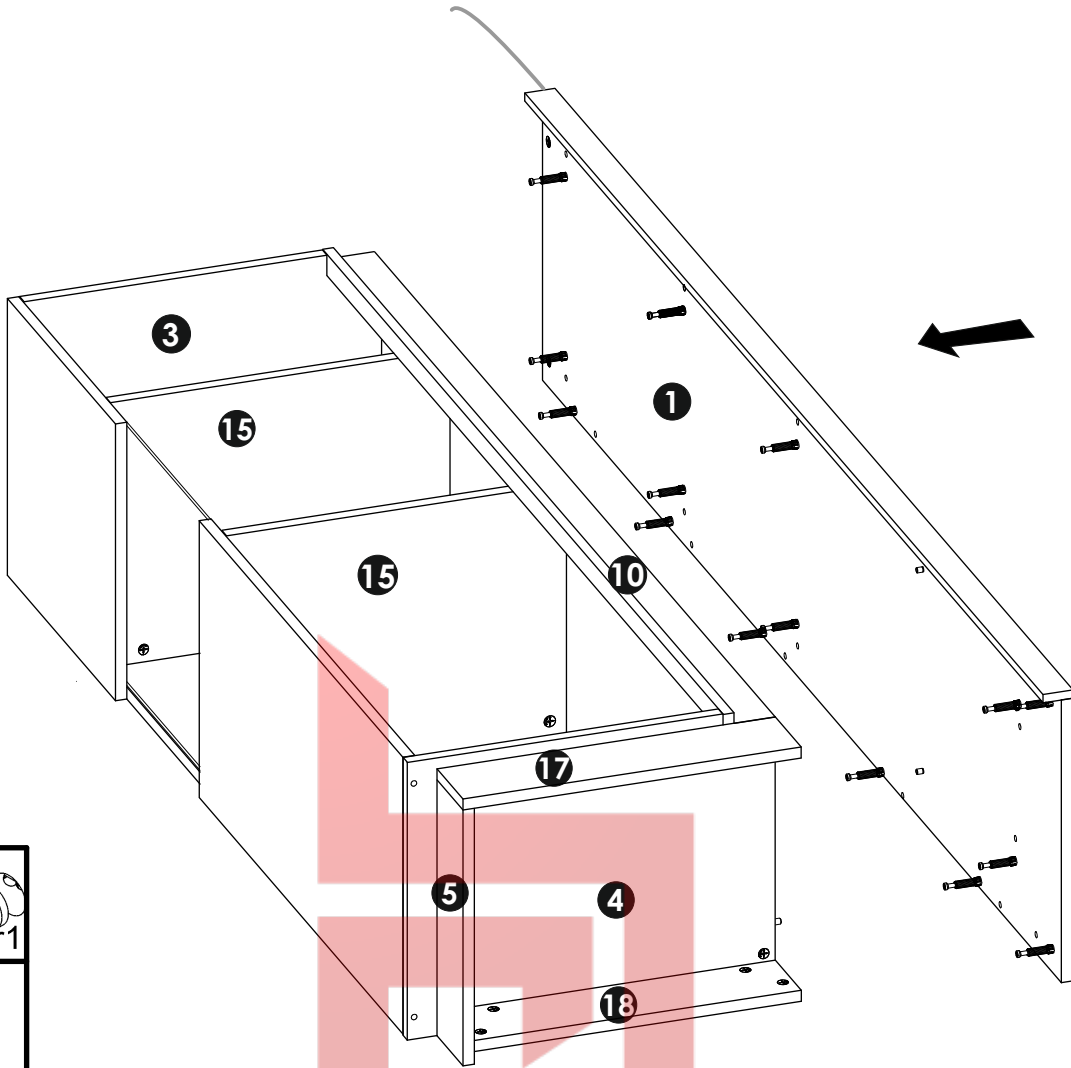

28

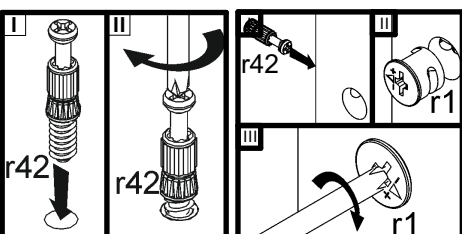
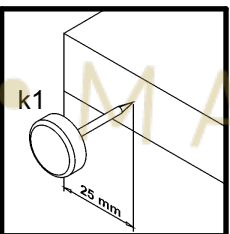
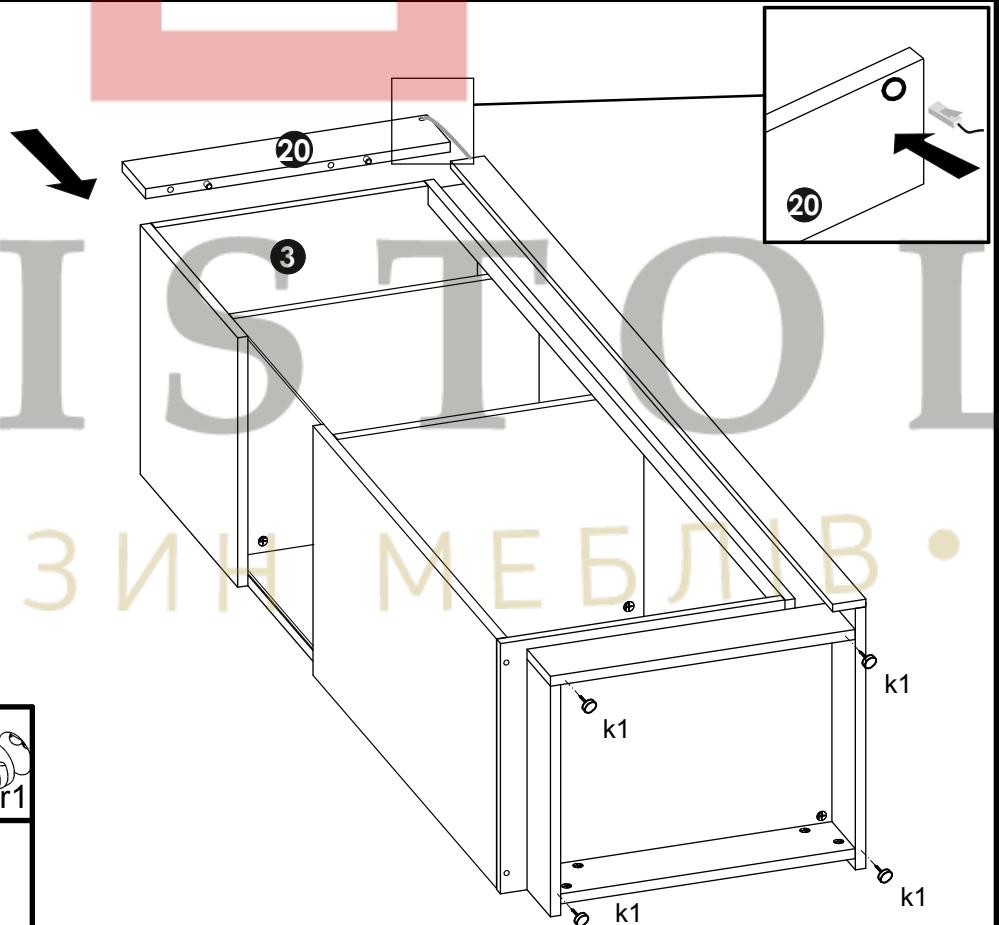

29

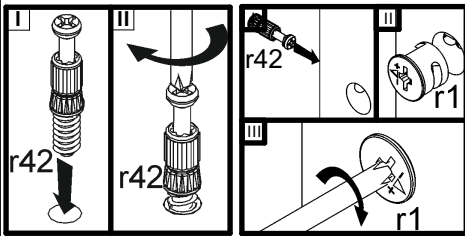
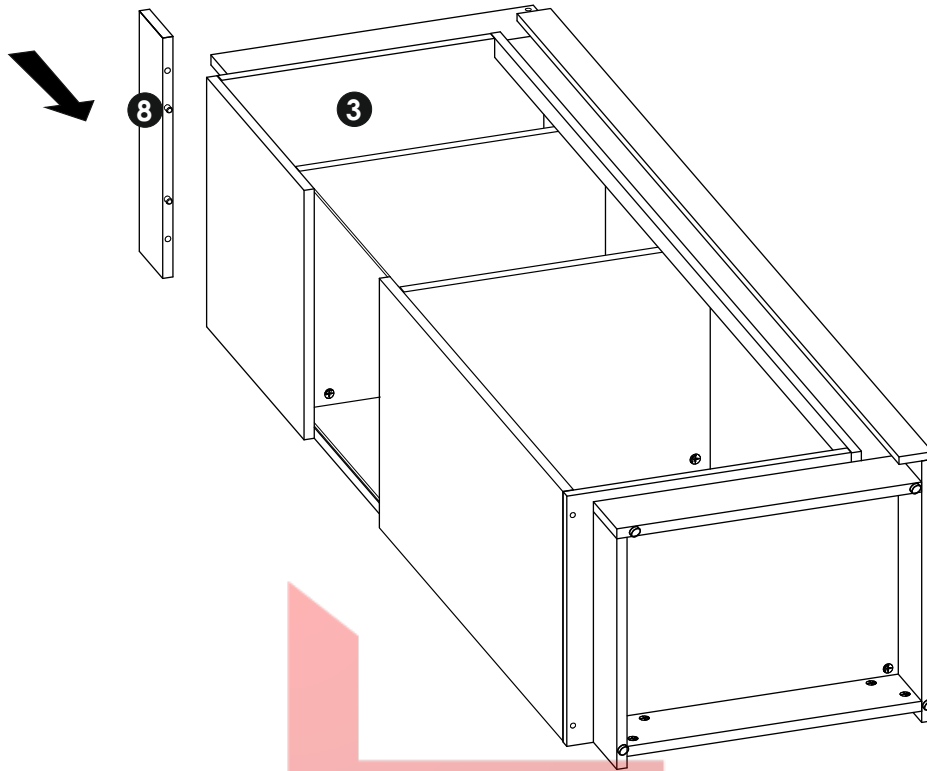

30

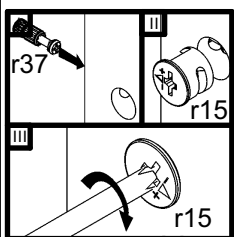
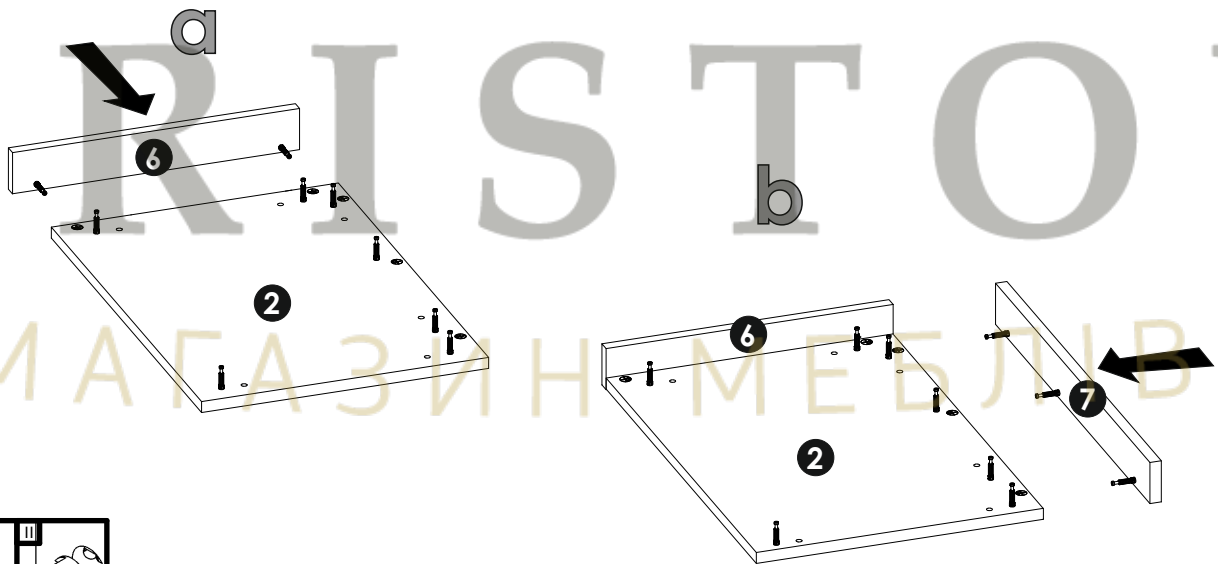

31

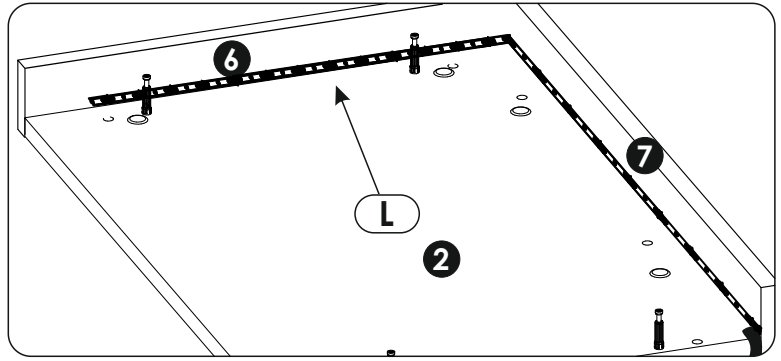
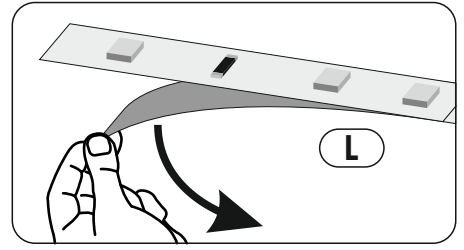
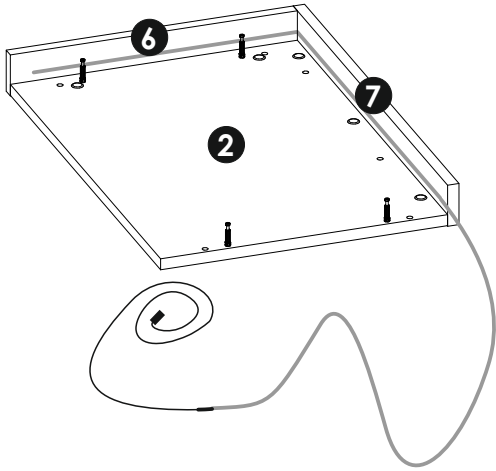

32

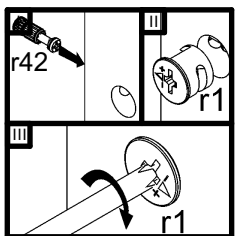
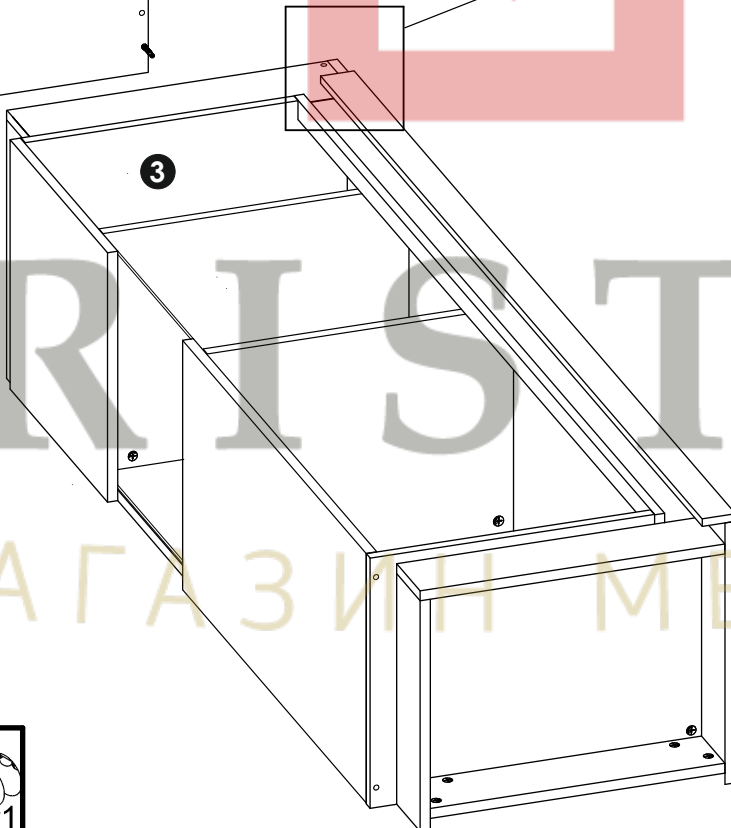
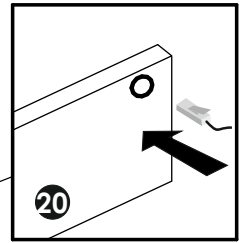
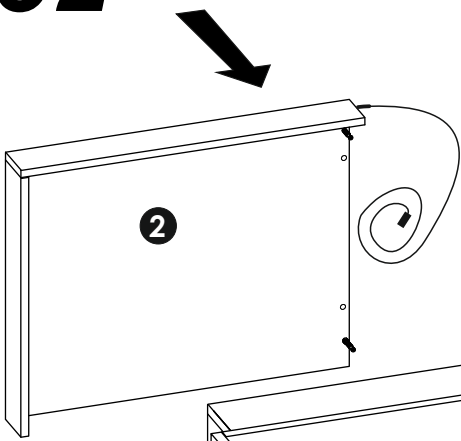

33

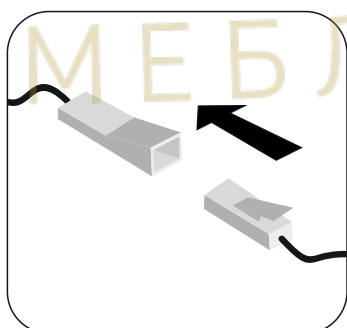
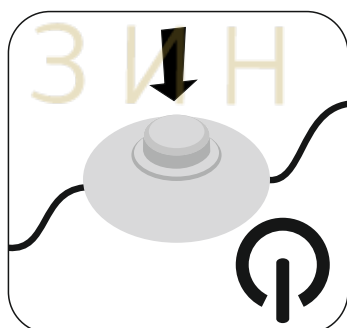
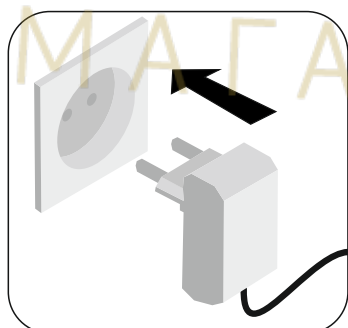
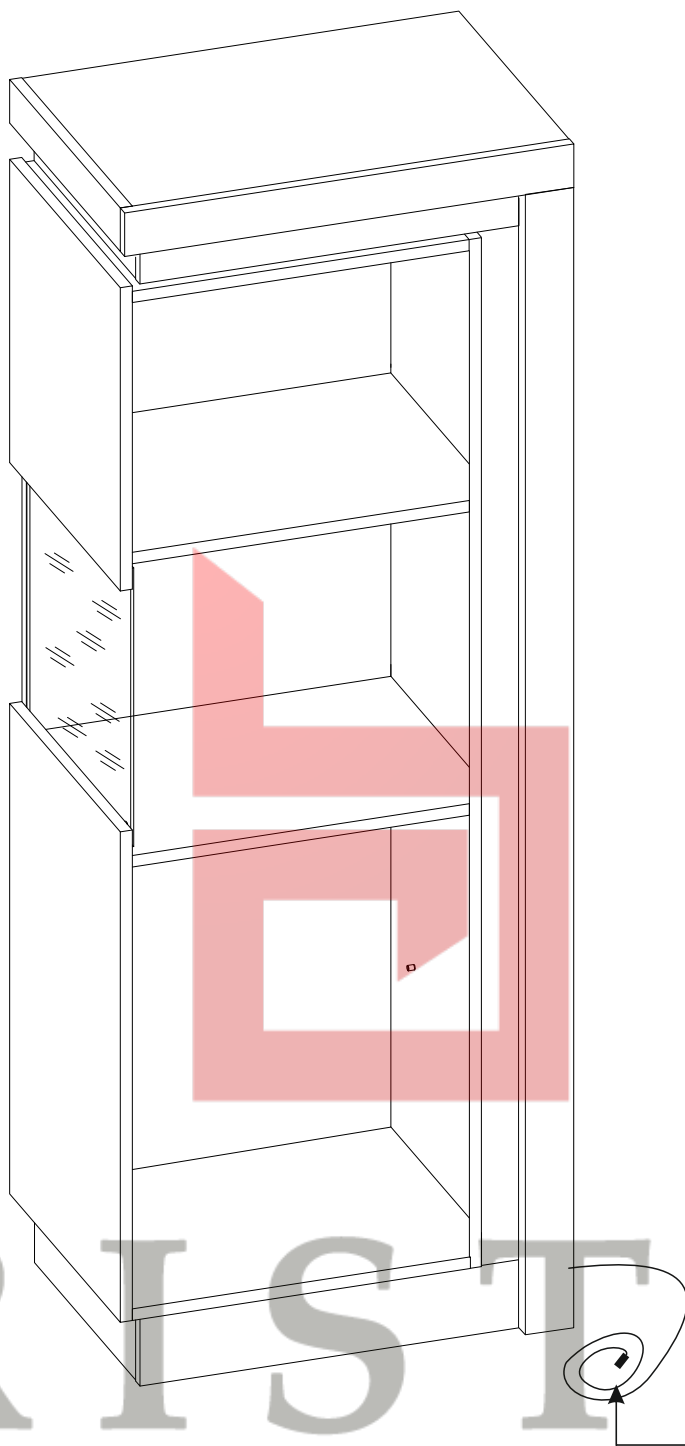

34

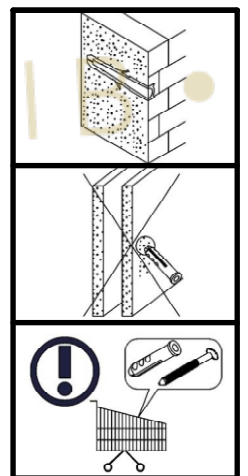
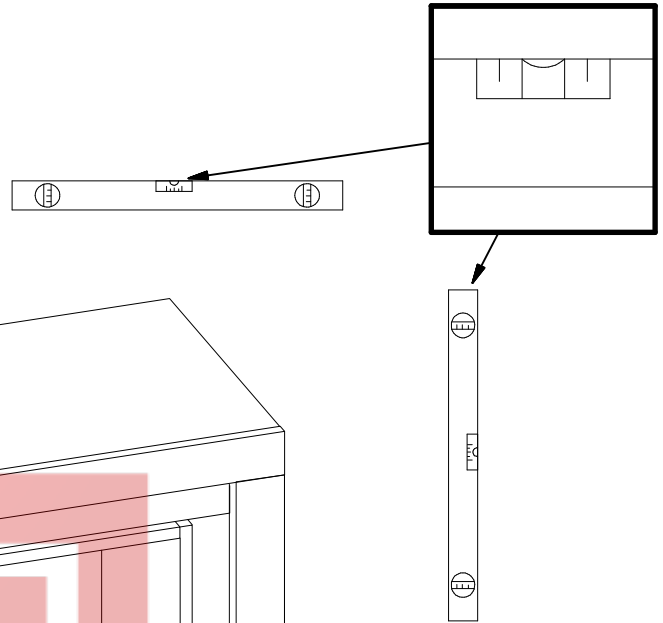
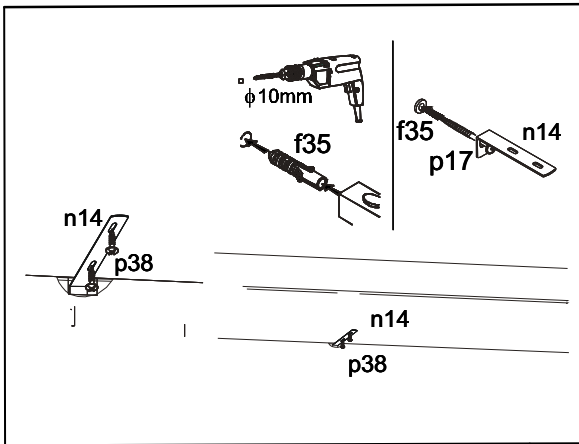

35

