

A	B	C	D
1	S239-0015	1025	200
2	S239-1013	815	392
3	S239-1014	815	392
4	S239-2011	1031	435
5	S239-2012	1031	421
6	WSQ4-505	350	140

A	B	C	D
7	WSQ4-506	350	140
8	WTQ-5071	940	140
9	S239-9506	1024	431
10	S239-9069	955	349
11	LH-996	996	14

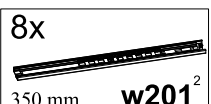

1 

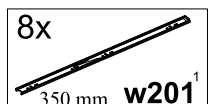
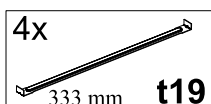
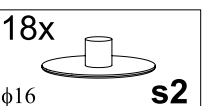
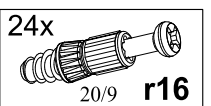
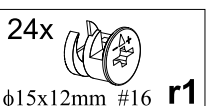
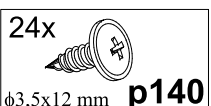
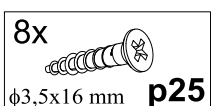
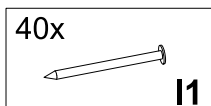
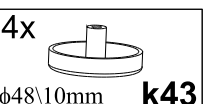
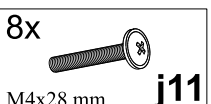
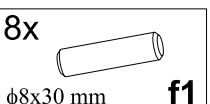
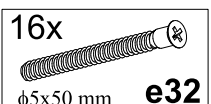
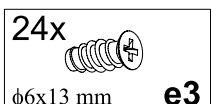
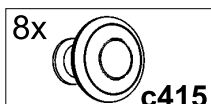
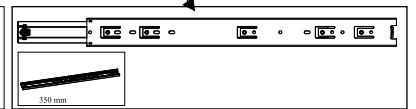
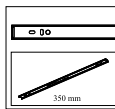
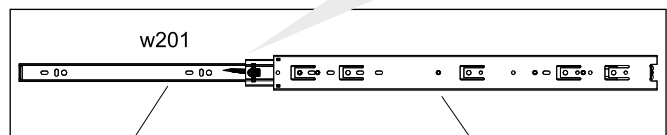
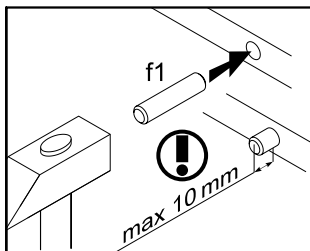
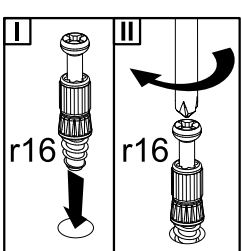
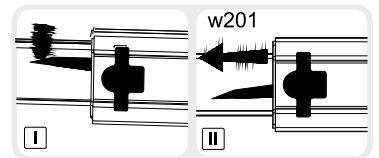
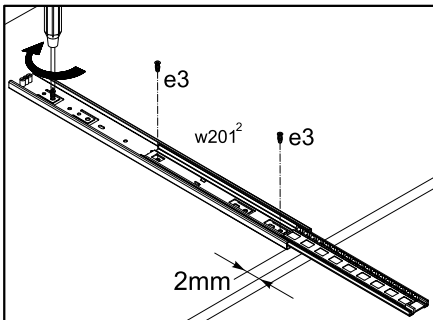
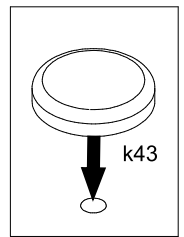
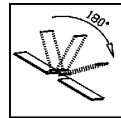
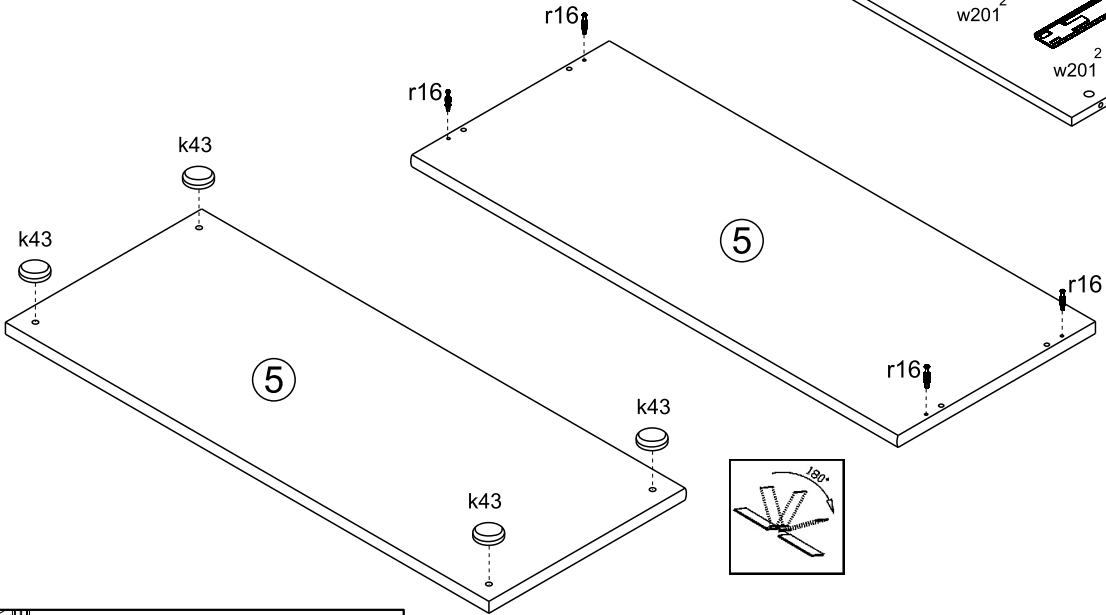
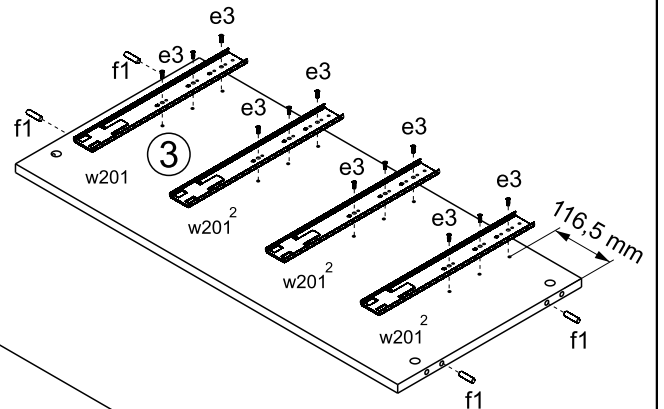
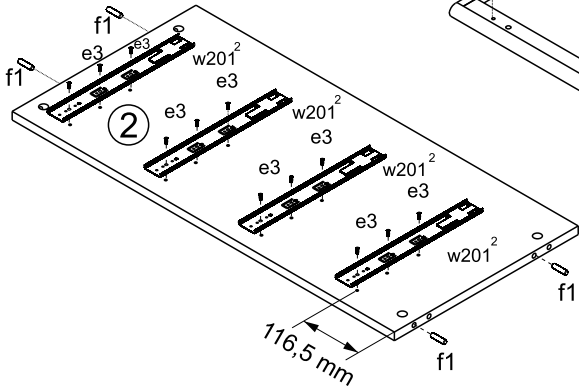
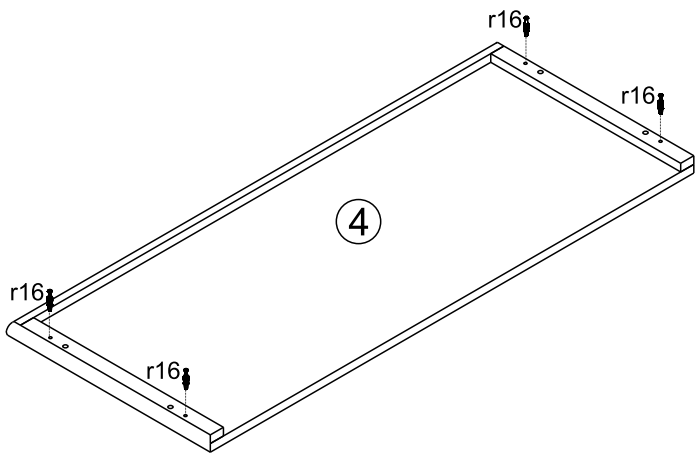

2

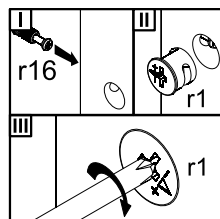
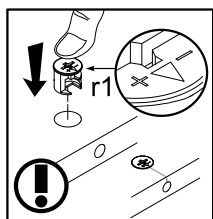
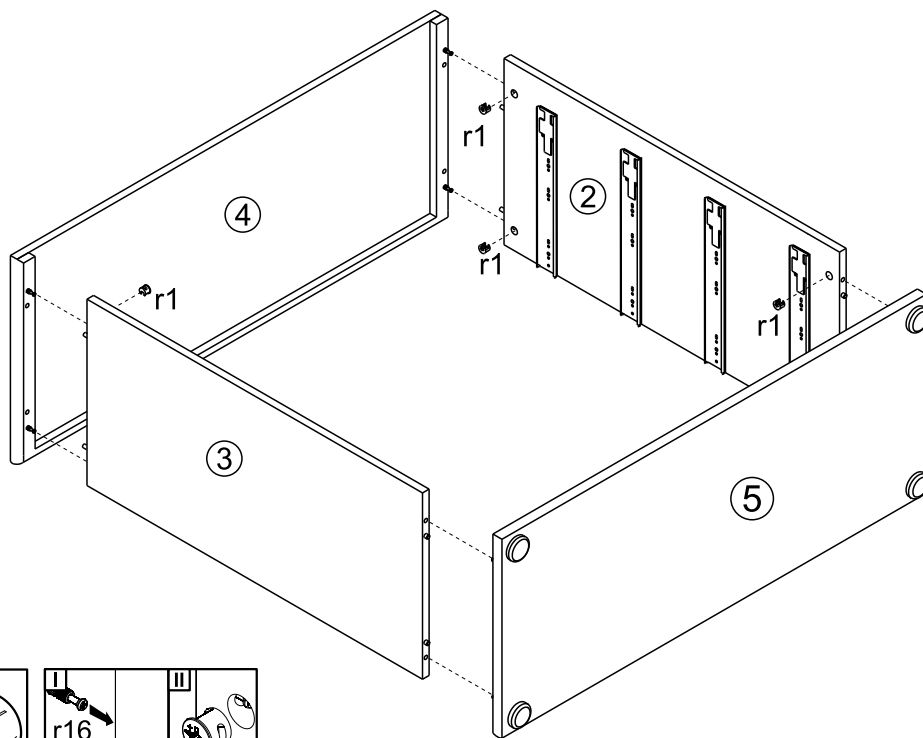

3

