

	A	B	C	D		A	B	C	D
1	S239-0016	511	200	3/3	8	S239-3004	490	382	2/3
2	S239-0008	809	511	3/3	9	WSQ4-505	350	140	2/3
3	S239-1013	815	392	2/3	10	WSQ4-506	350	140	2/3
4	S239-1015	815	392	2/3	11	WTQ-5070	433	140	2/3
5	S239-1016	815	392	2/3	12	S239-9068	448	349	1/3
6	S239-2007	1031	435	1/3	13	S239-9504	864	255	1/3
7	S239-2008	1031	421	1/3	14	LH-830	830	14	1/3

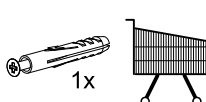

1

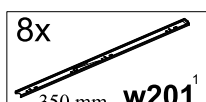
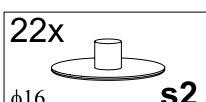
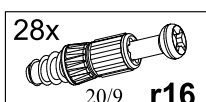
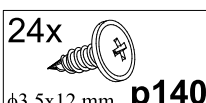
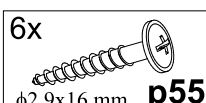
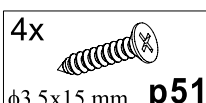
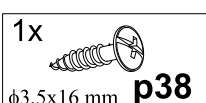
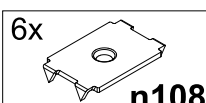
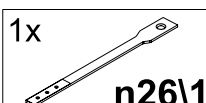
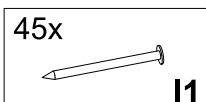
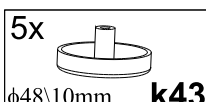
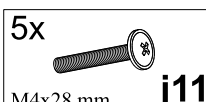
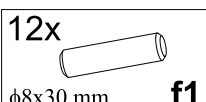
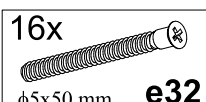
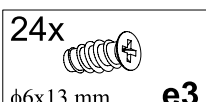
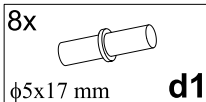
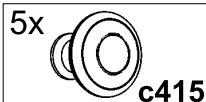
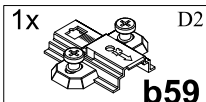
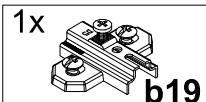
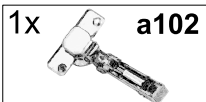
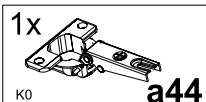
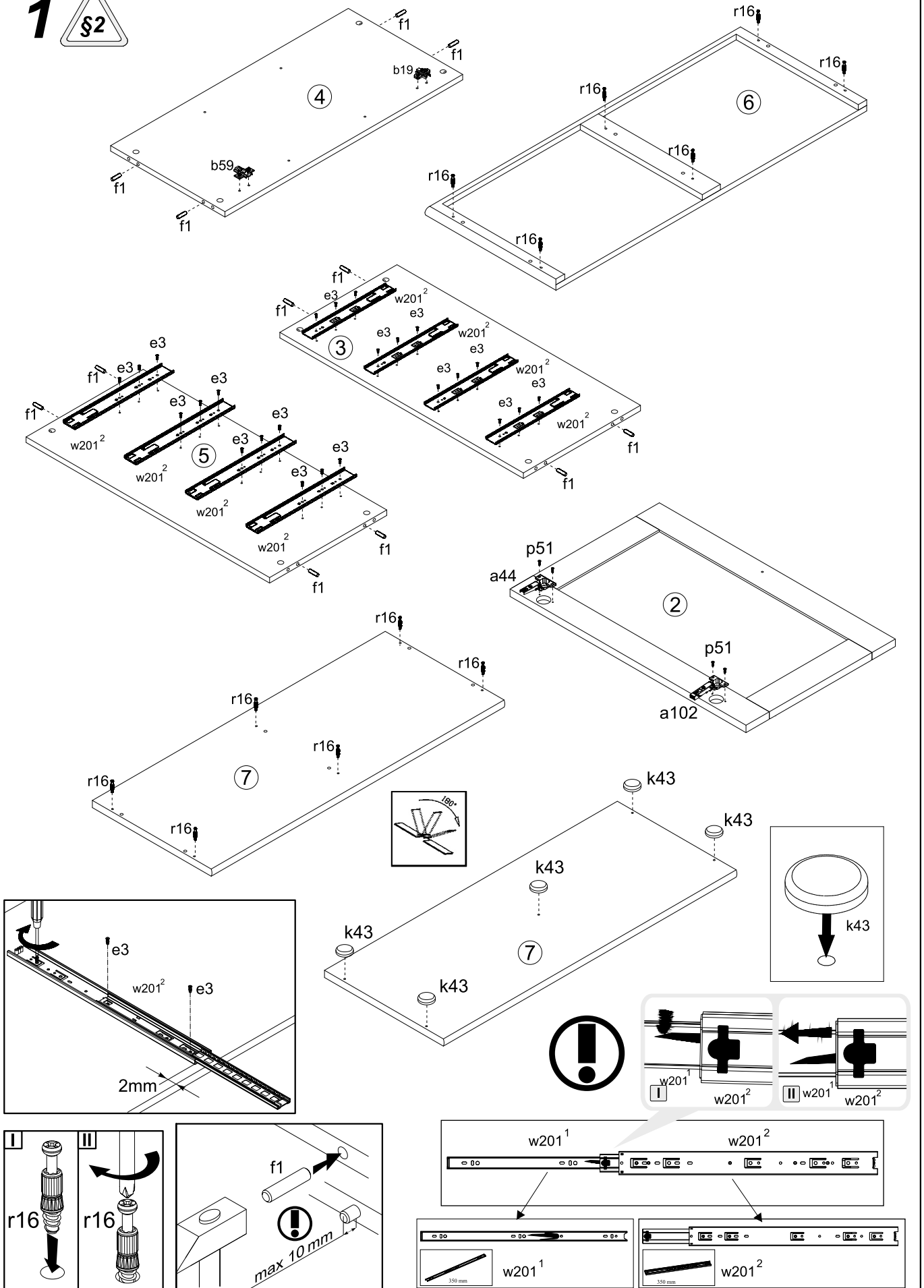

2

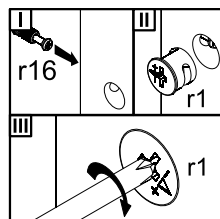
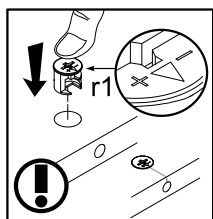
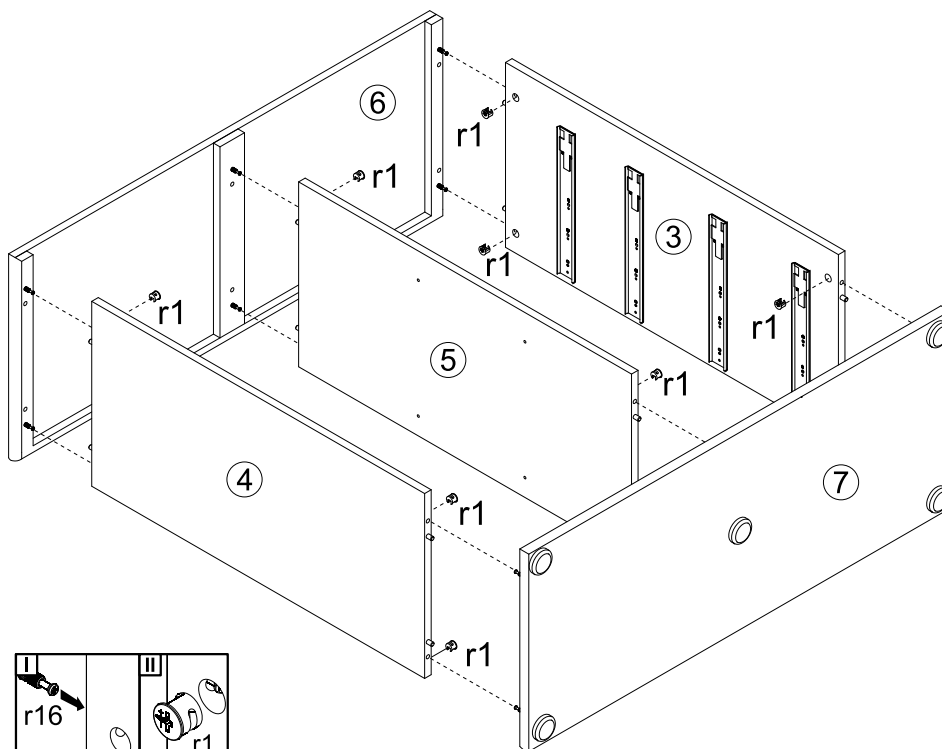

3

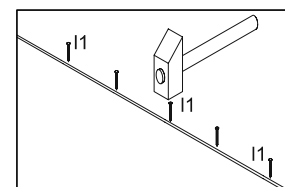
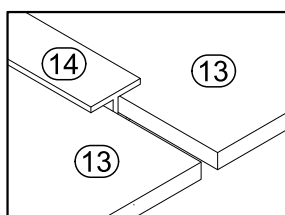
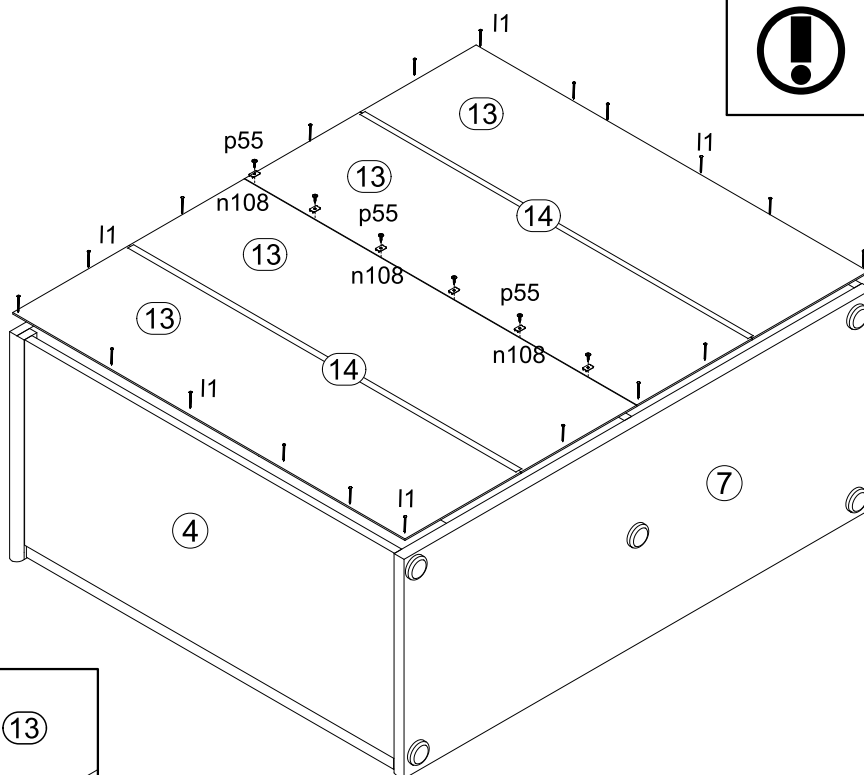
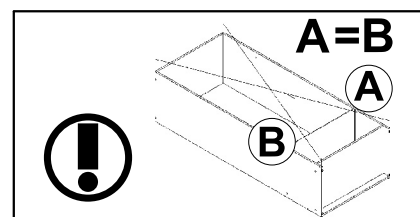

4

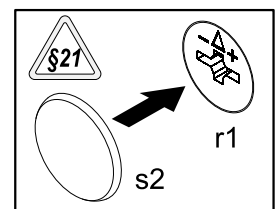
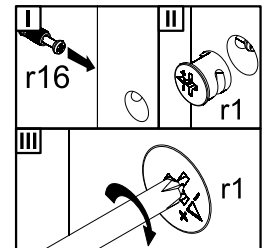
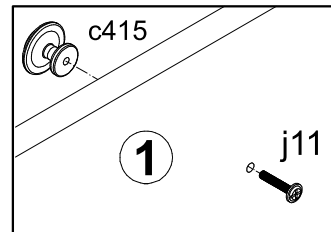
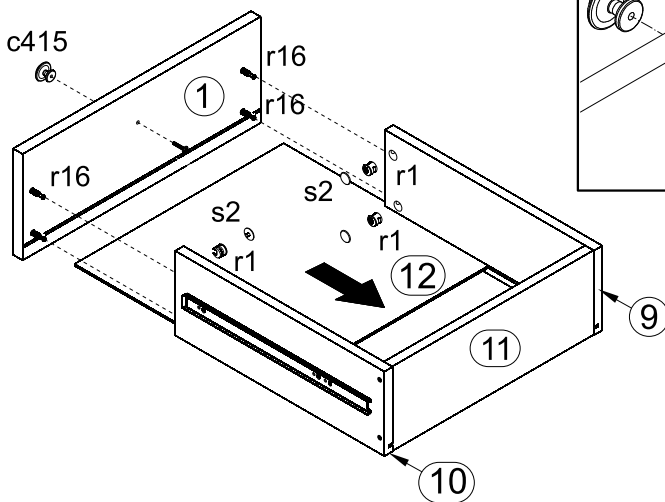
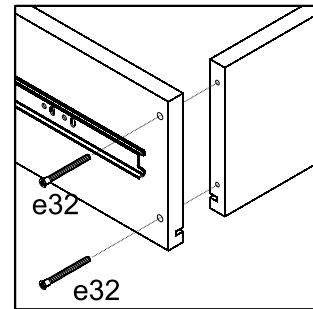
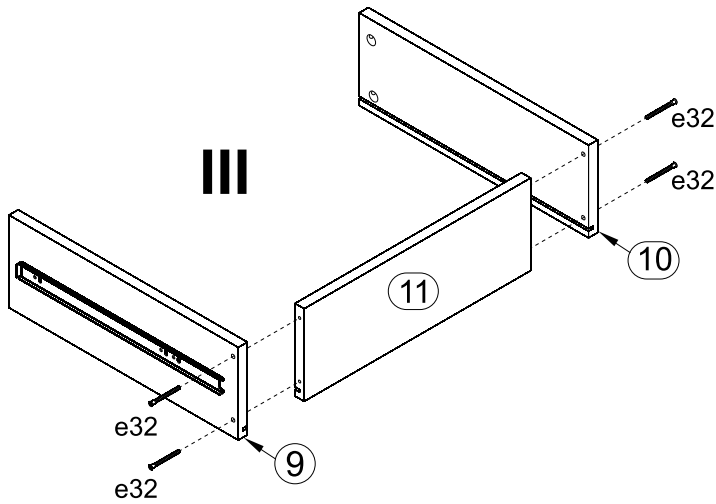
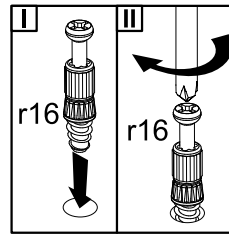
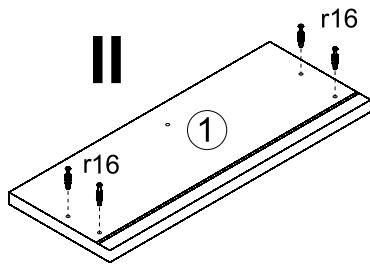
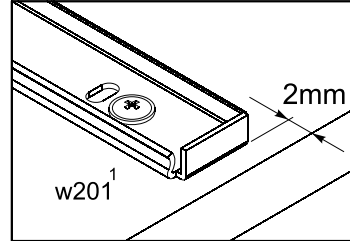
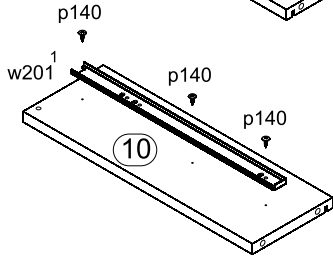
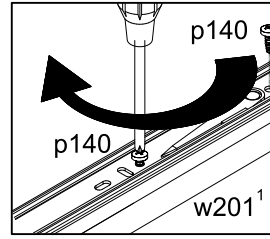
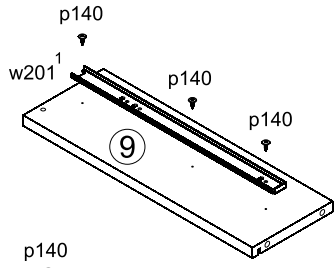

5

