

A	B	C		D
1	S239-0010	1650	270	1/4
2	S239-0011	1650	978	1/4
3	S239-5708	1651	41	1/4
4	S239-1007	2000	250	2/4
5	S239-1008	2000	250	2/4
6	S239-1012	1603	200	2/4
7	k120/1	250	112	3/4
8		1600	2000	4/4

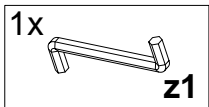

1 

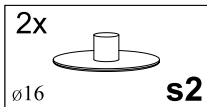
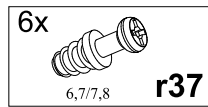
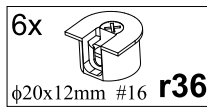
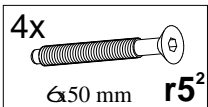
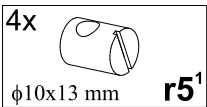
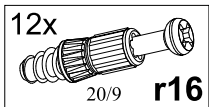
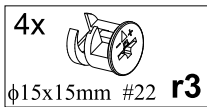
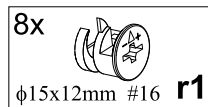
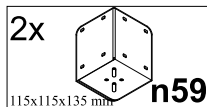
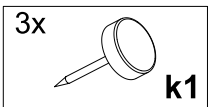
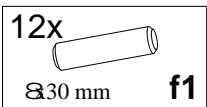
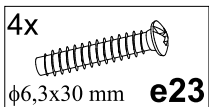
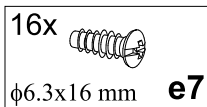
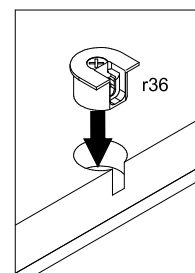
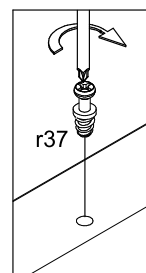
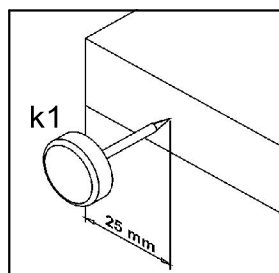
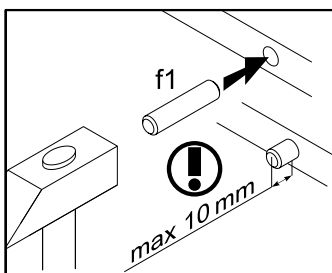
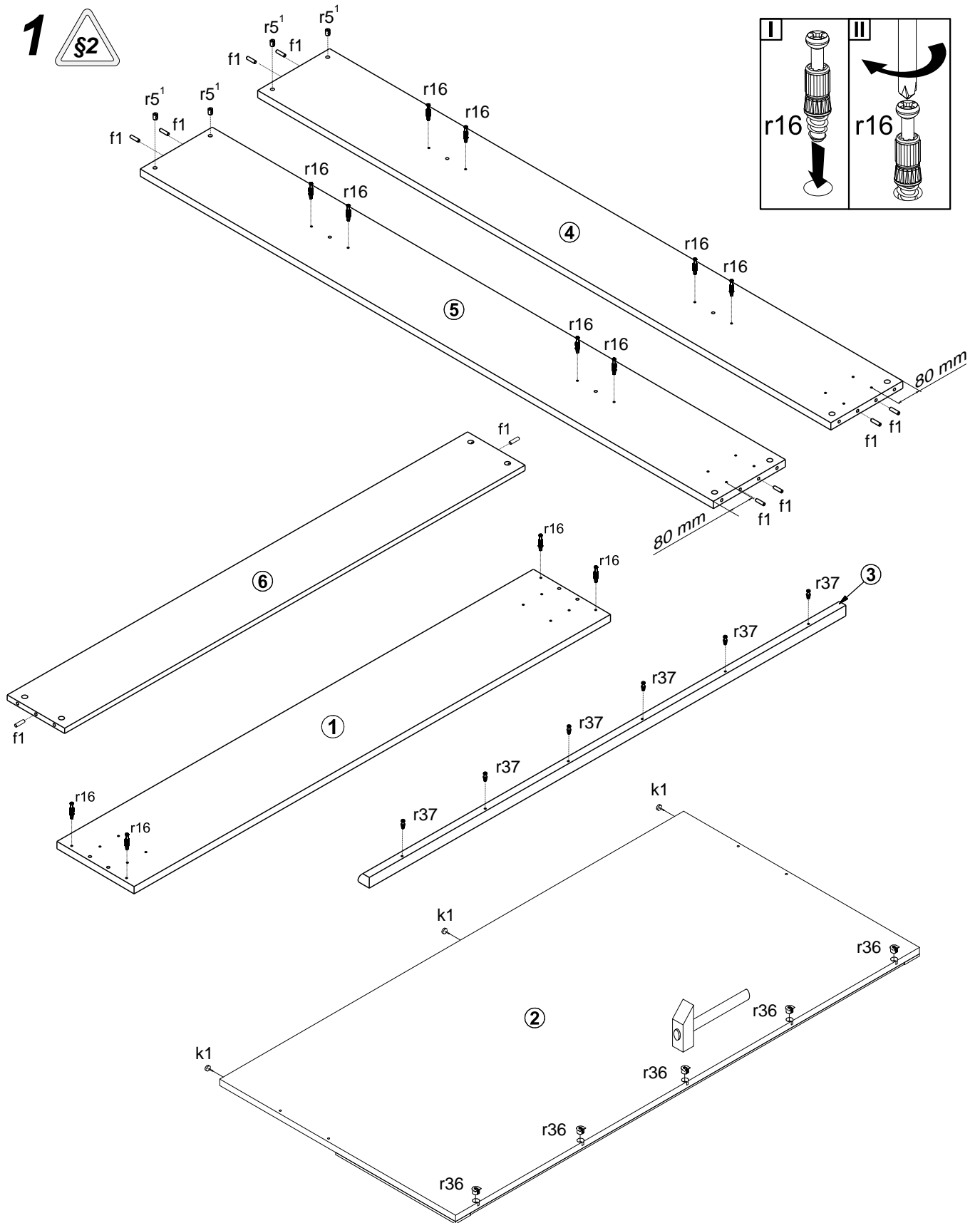
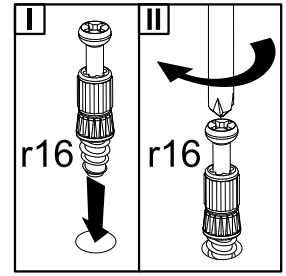

# 2

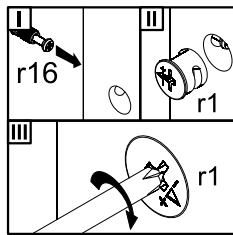
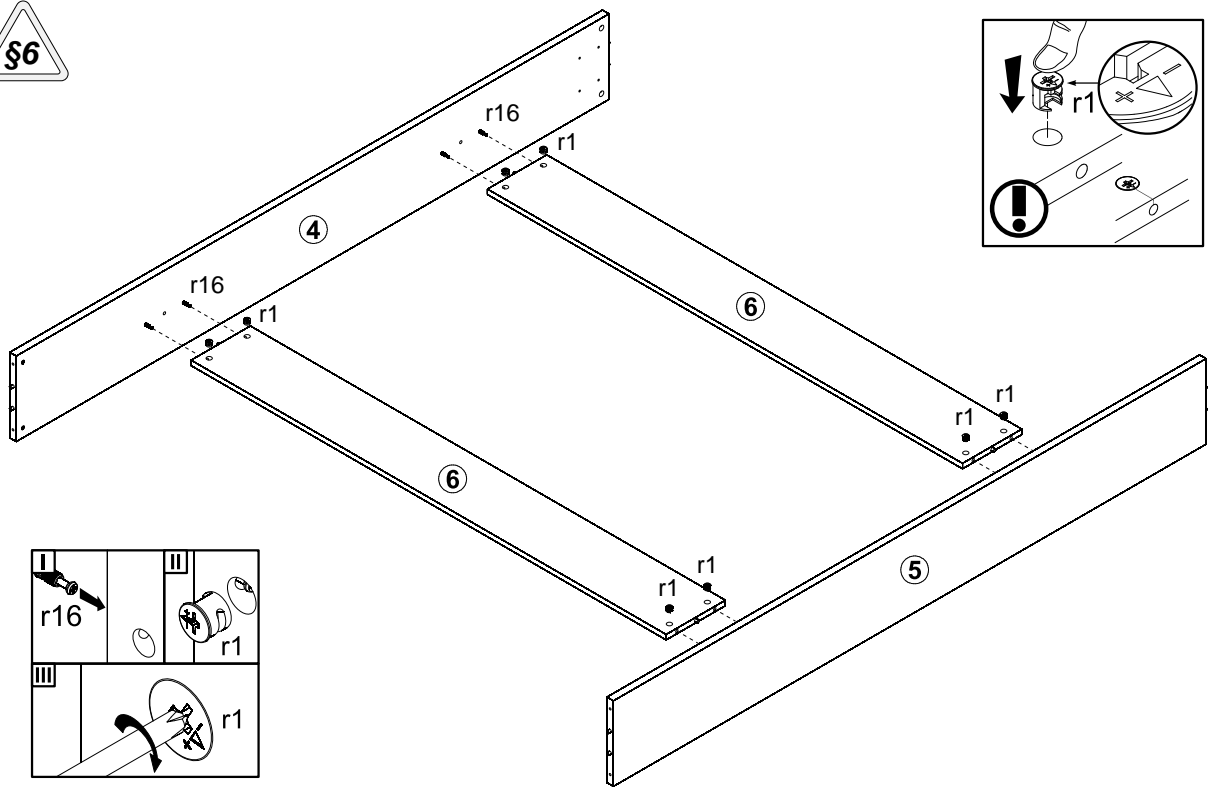

# 3

