

/

/ Erika

/

/ Glass-fronted cabinet KOM3W3D

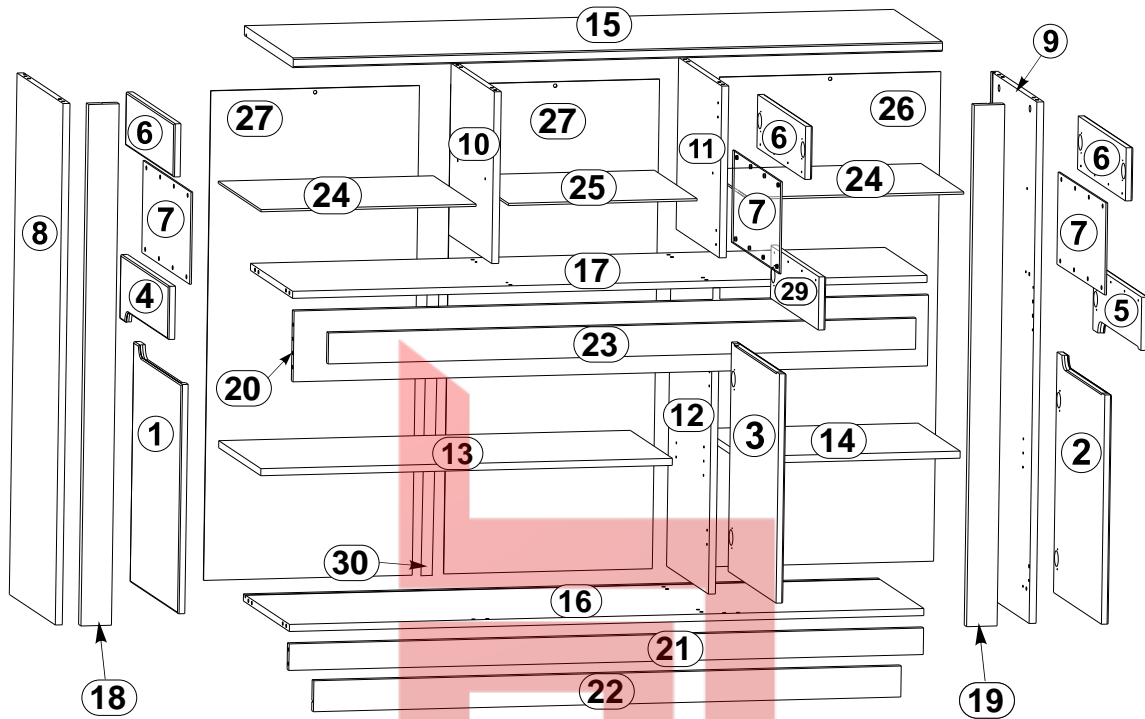
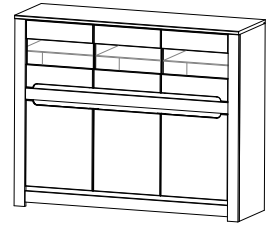
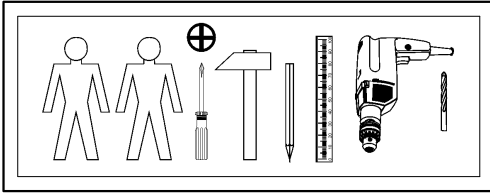

1	S404-0004	446	543	4/4	11	S404-1043	388	402	1/4	21	S404-4004	1457	60	2/4
2	S404-0003	446	543	4/4	12	S404-1045	692	392	1/4	22	S404-5005	1349	70	2/4
3	S404-0006	446	518	4/4	13	S404-3004	945	382	1/4	23	S404-5006	1349	70	2/4
4	S404-0022	446	145	4/4	14	S404-3005	495	382	1/4	24	S404-3023	494	393	4/4
5	S404-0023	446	145	4/4	15	S404-2012	1491	454	2/4	25	S404-3025	433	393	4/4
6	S404-0047	446	120	4/4	16	S404-3003	1457	428	2/4	26	S404-9308	1106	508	1/4
7	S404-5034	208	445	3/4	17	S404-3024	1457	392	2/4	27	S404-9309	1106	479	1/4
8	S404-1010	1178	428	1/4	18	S404-5032	1178	70	1/4	28	LH-1095	1095	14	1/4
9	S404-1011	1178	428	1/4	19	S404-5033	1178	70	1/4	29	S404-0054	446	120	4/4
10	S404-1044	388	402	1/4	20	S404-4003	1457	160	2/4					

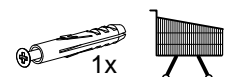
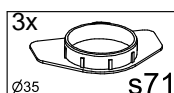
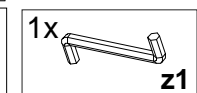
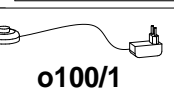
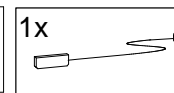
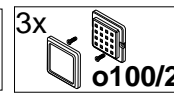
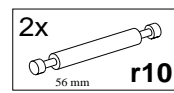
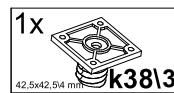
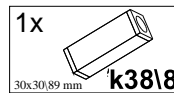
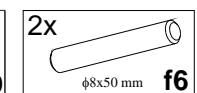
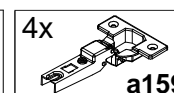
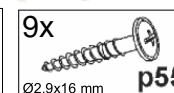
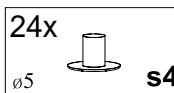
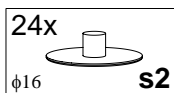
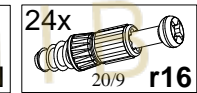
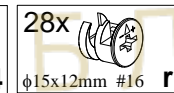
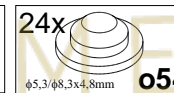
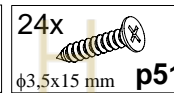
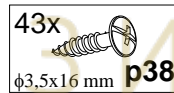
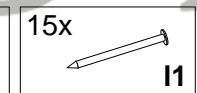
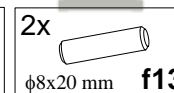
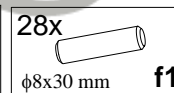
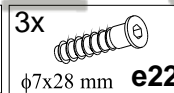
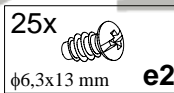
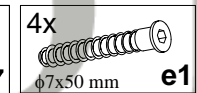
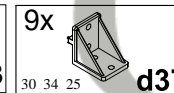
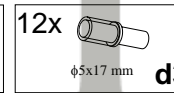
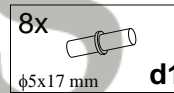
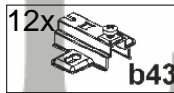
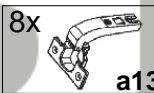

1 

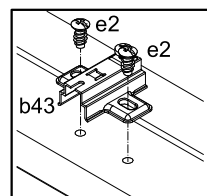
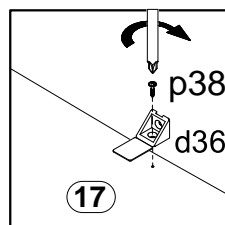
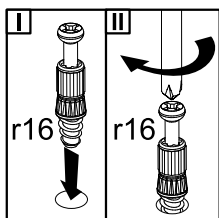
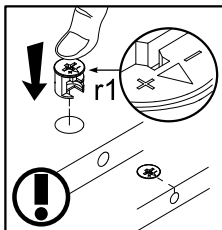
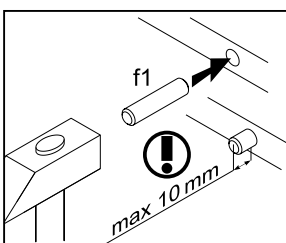
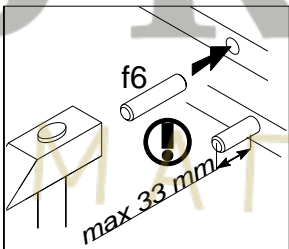
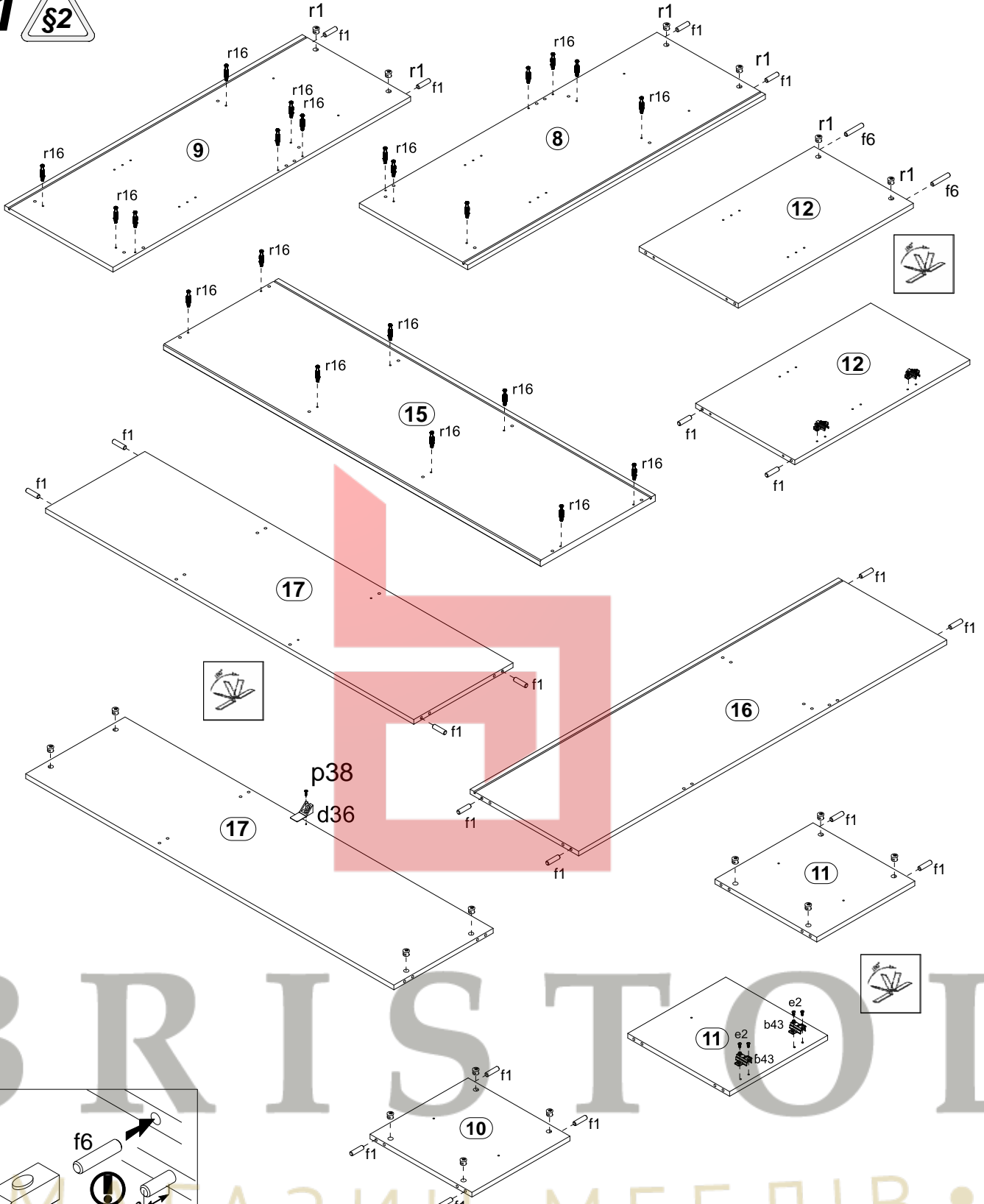

2

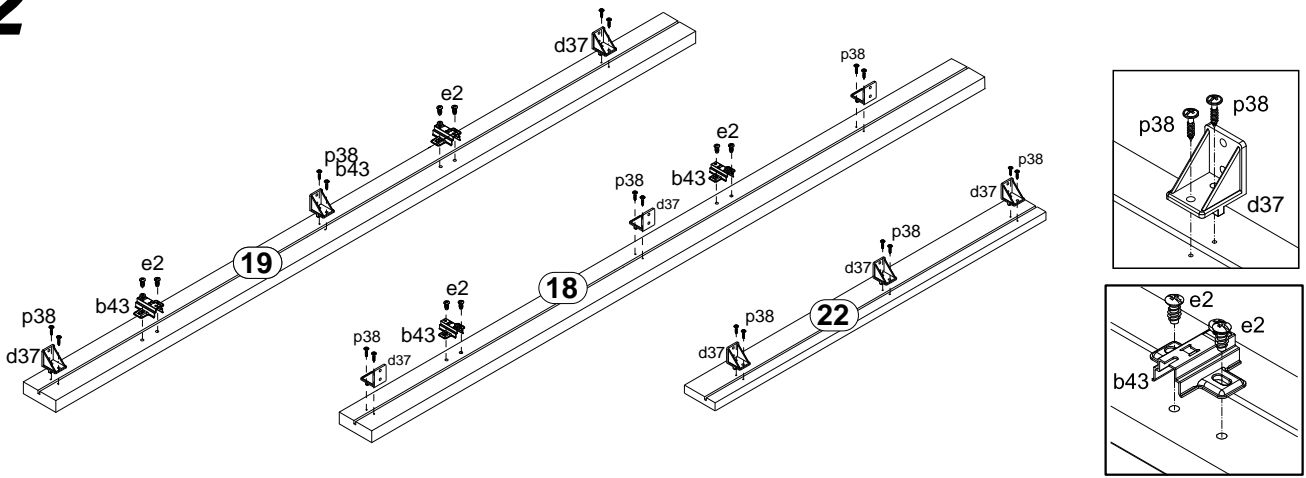

3

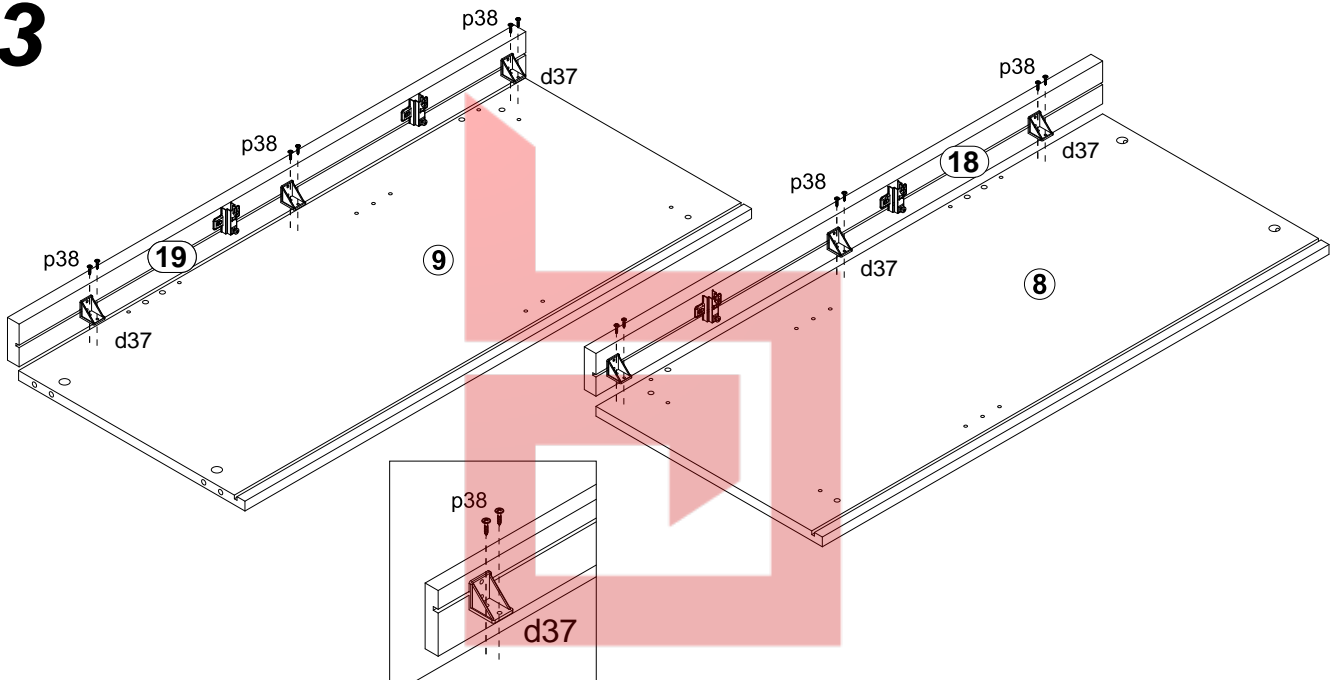

4

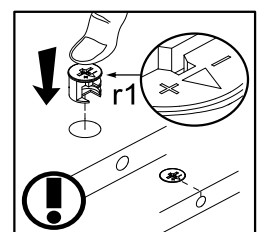
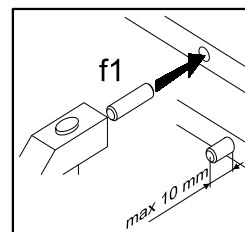
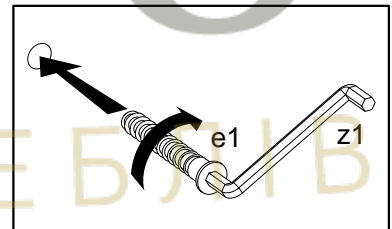
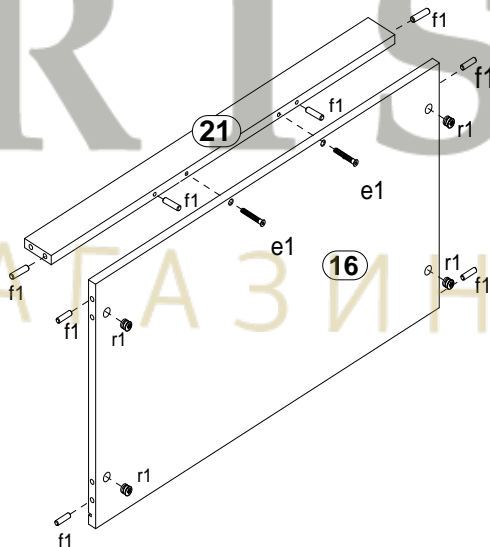

5

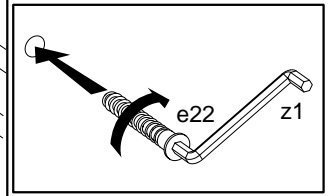
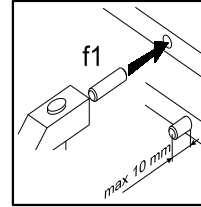
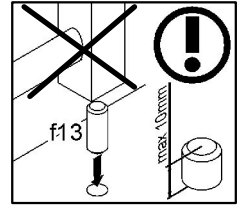
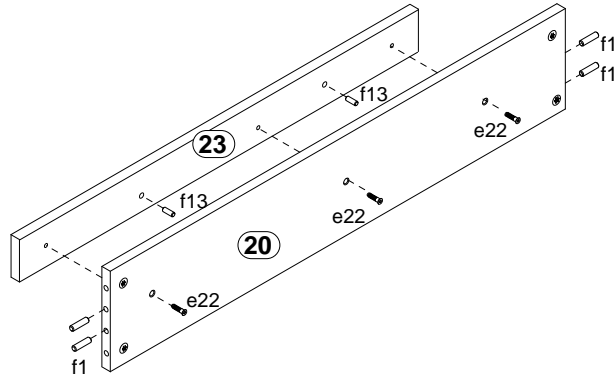

6

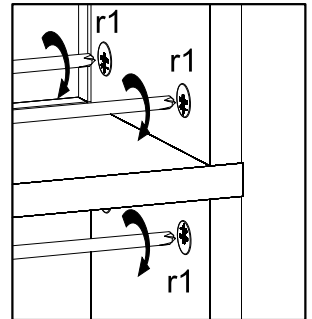
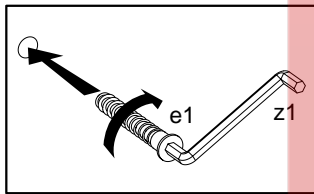
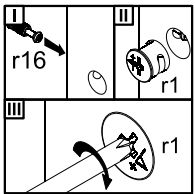
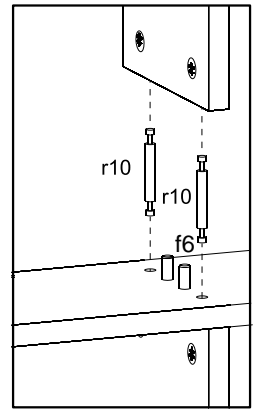
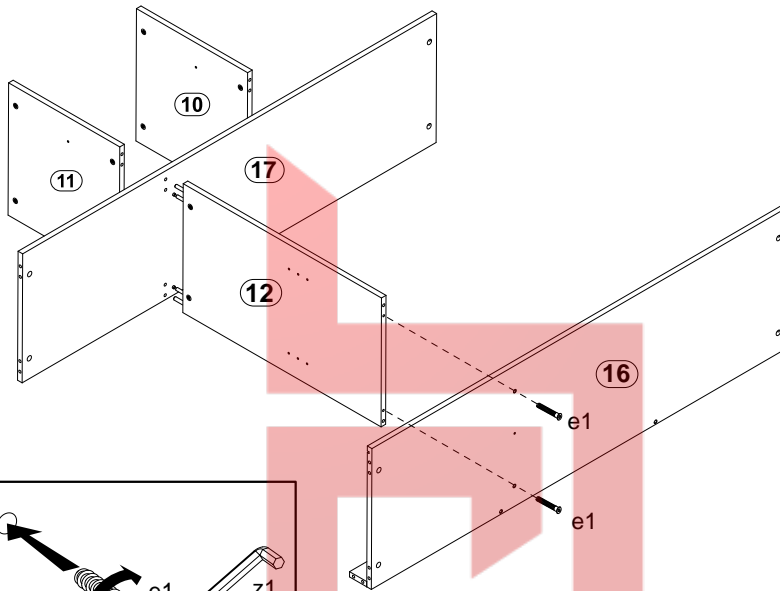

7

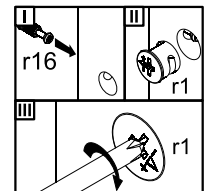
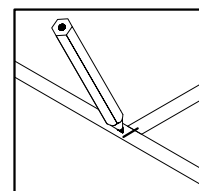
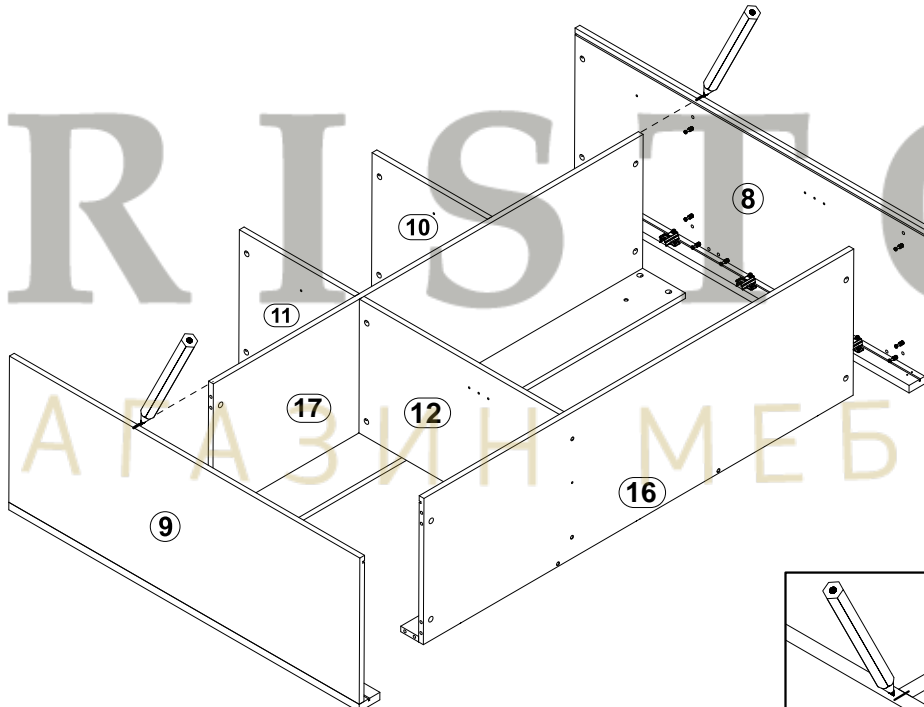

8

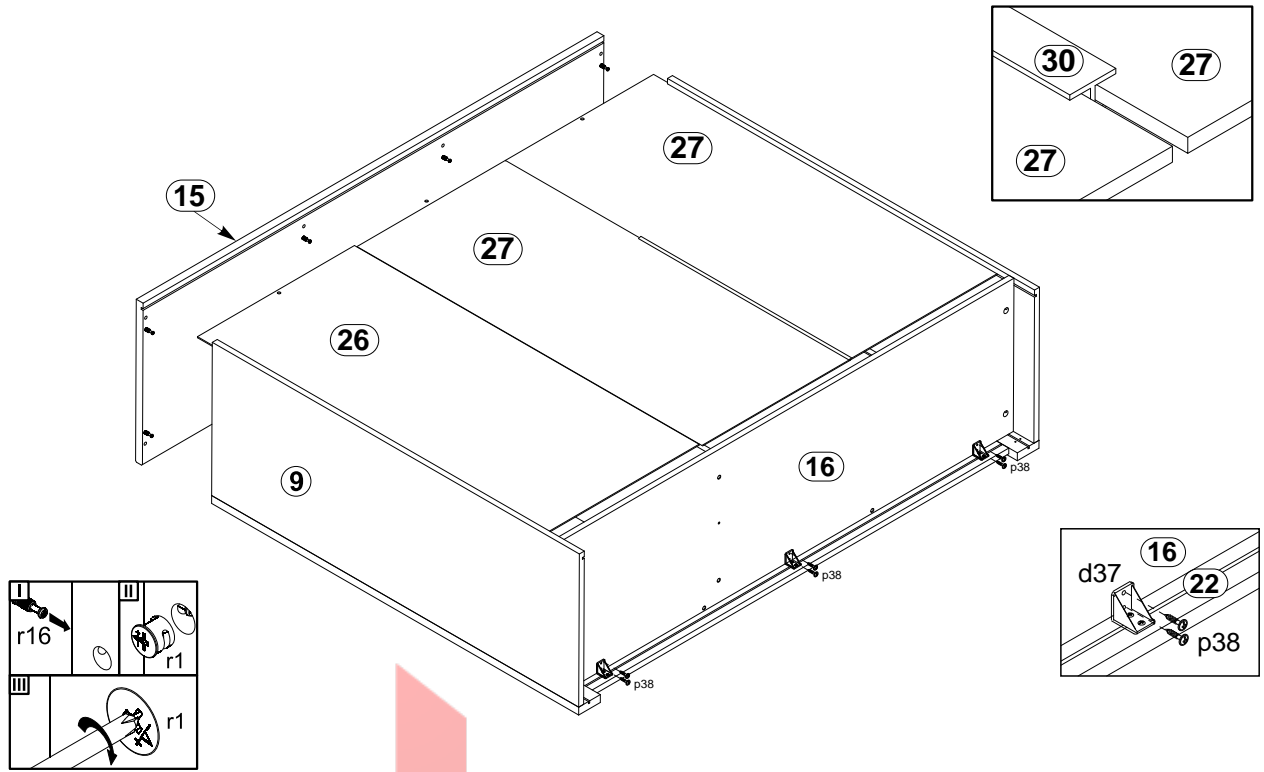

9

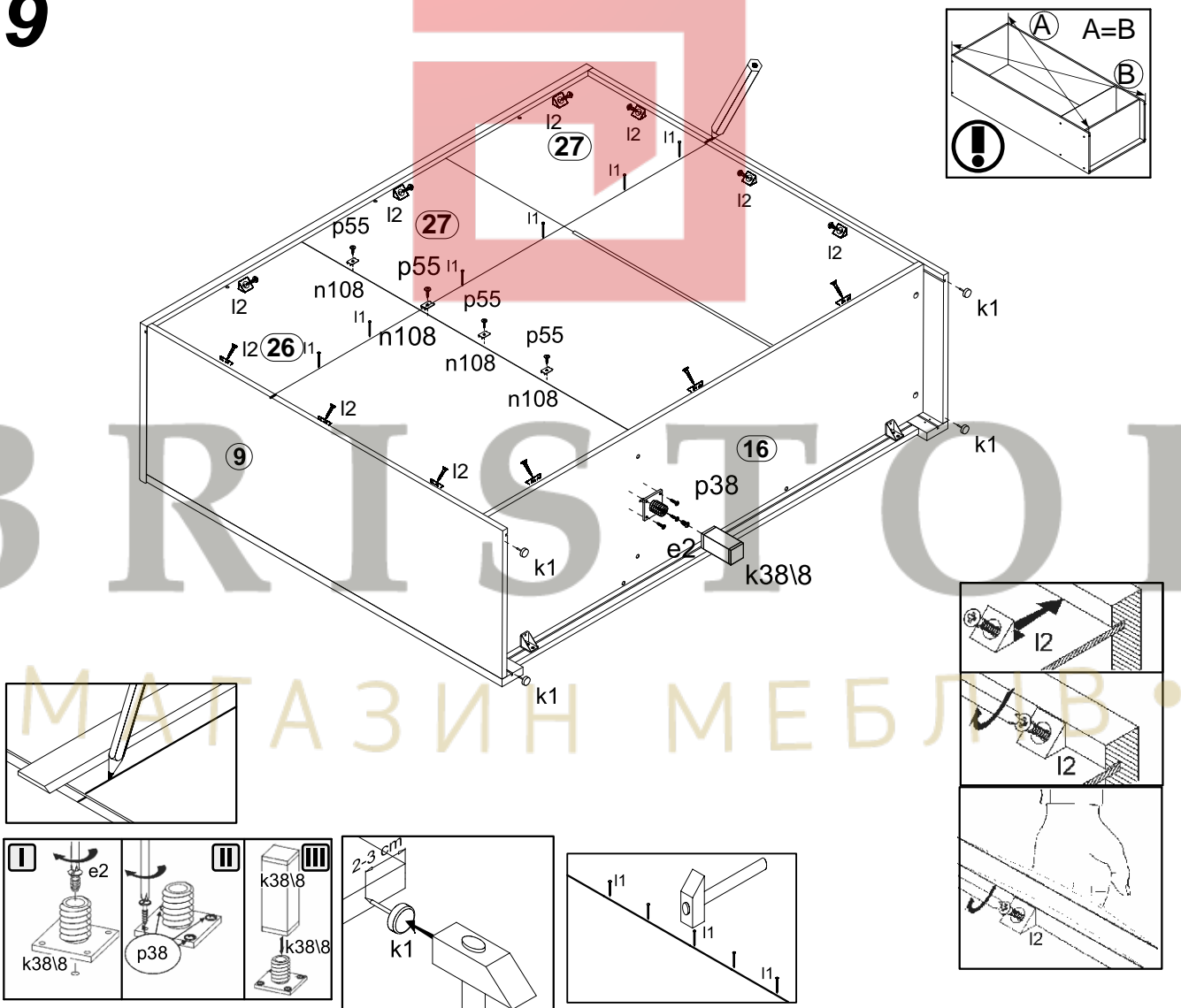

10

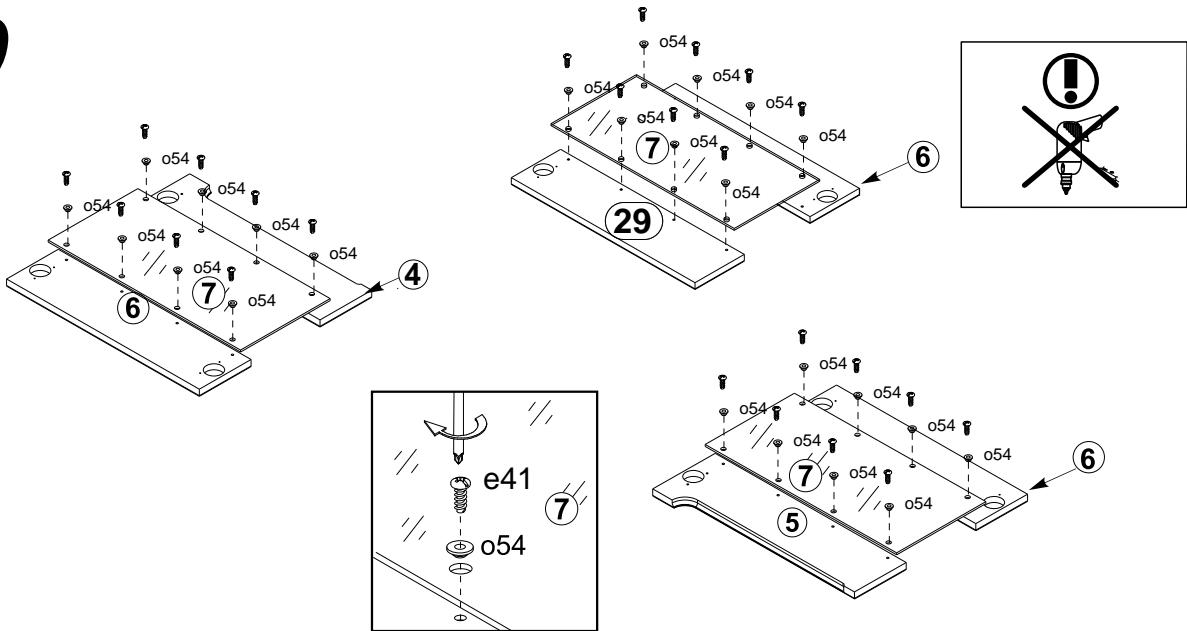

11

