

A	B	C		D
1	LN1-122	156	185	1/1
2	LN1-306	1000	185	1/1
3	LN1-406	456	155	1/1
4	LN1-405	1500	300	1/1

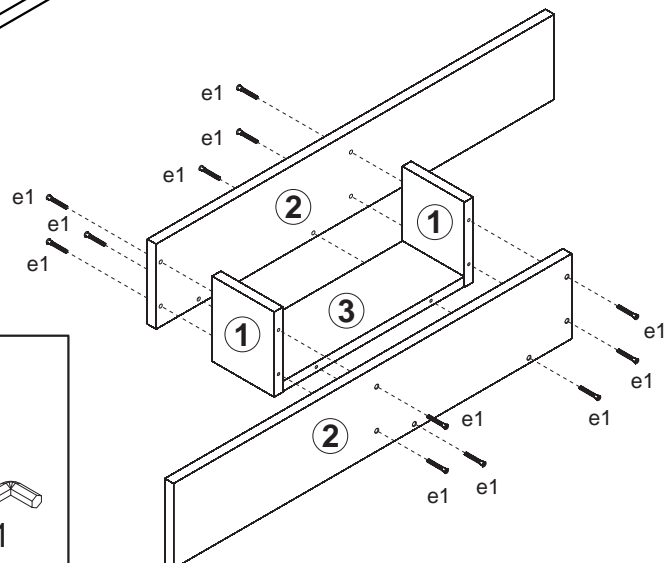

3

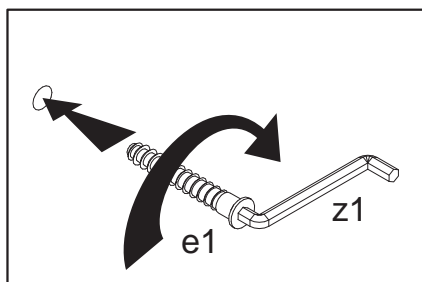
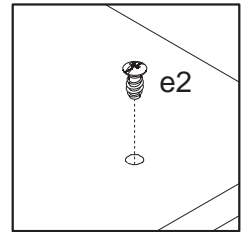
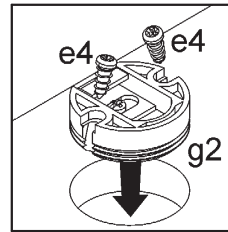
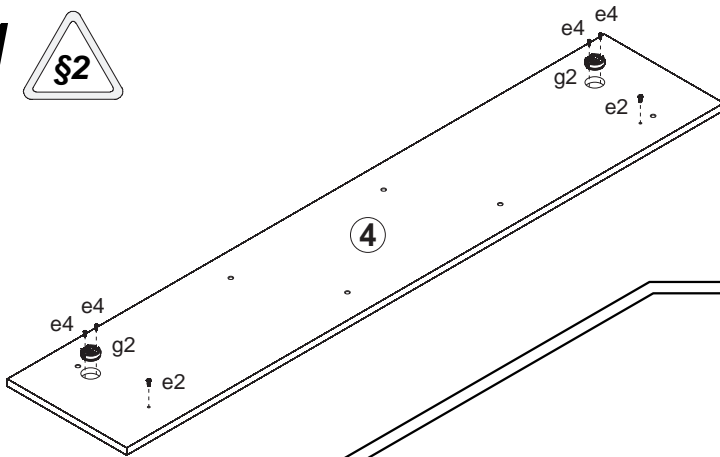
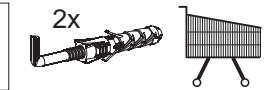
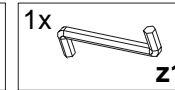
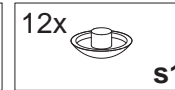
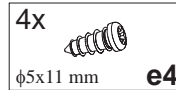
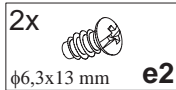
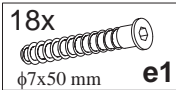
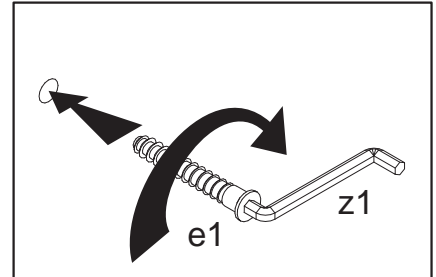
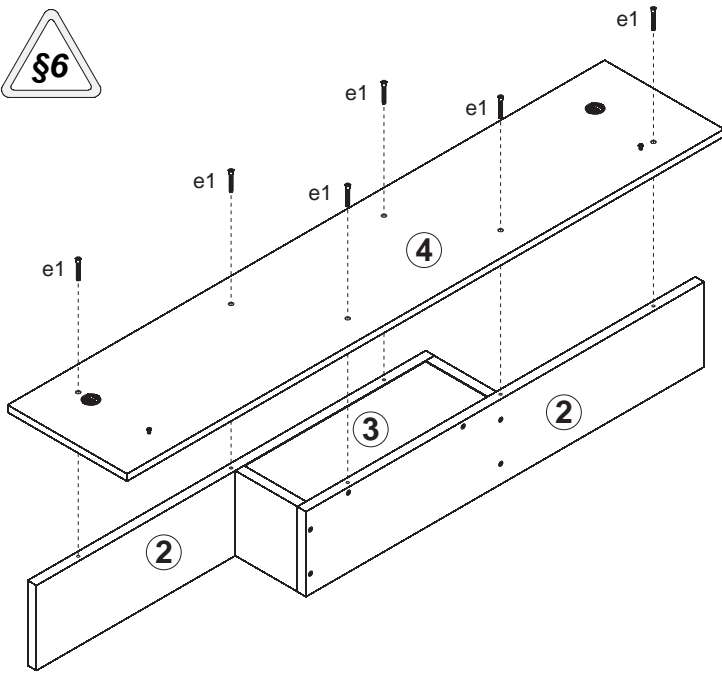

4

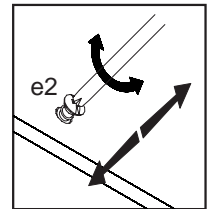
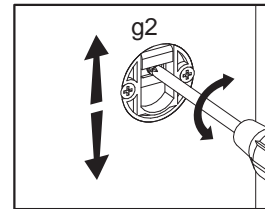
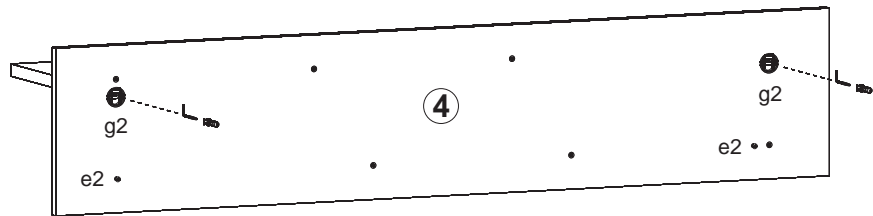
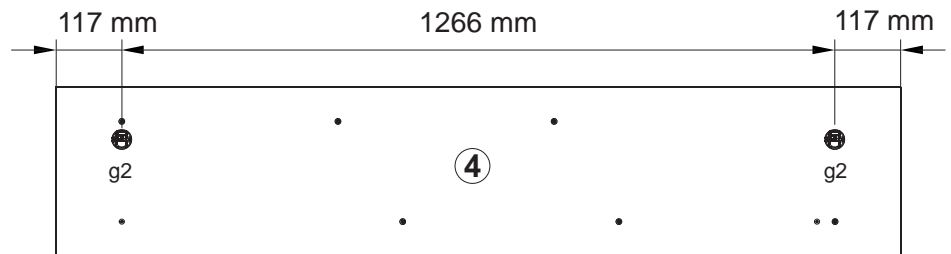
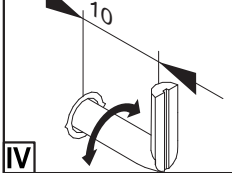
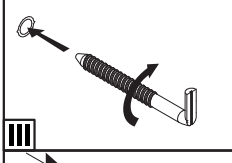
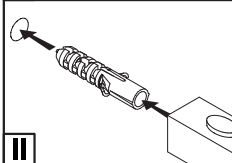
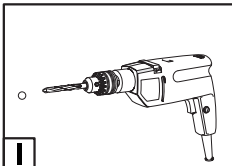

5

